



98-02 GM F-Body Fuel Pump Module Instructions

12-362	98-02 GM F-Body Single 340LPH Pump Module
12-363	98-02 GM F-Body Single 450LPH Pump Module
12-364	98-02 GM F-Body Twin 340LPH Pump Module
12-365	98-02 GM F-Body Twin 450LPH Pump Module

NOTE: Please read all instructions before proceeding with the installation of your new drop in fuel cell pump hanger. Failure to follow these instructions may result in poor performance, vehicle damage, personal injury, or death. If these instructions are not fully understood an installation should not be attempted. In this case, please contact Holley's tech service department or a qualified mechanic.

Parts Included:

Qty.	Description
1	Fuel Pump Hanger Assembly
1 or 2	3 x 11" HydraMats (10 micron)
1	4-Wire Pump Power Vehicle Harness
1	2-Wire Level Sender Harness (Twin Pump Models)
1	Level Sender Arm
1	Factory Feed & Return Fitting Kit

Parts Required for Installation:

- **Post Pump Filter:** Each of the Pre-Filters that come with the module are 10 micron filters, making the use of post filters optional, not required.
- **Relay Kit (30A Min) – Holley P/N 12-759** for twin pump models, **Holley 12-753** for single pump models
 - One relay is needed for each pump.
 - Additional wire and connectors may be necessary.
- **Fuel Hose and Fittings**
 - **NOTE:** These pump assemblies are not designed to use a standard conical seat style union for the fuel out or fuel return. Using this type of fitting will restrict flow and will lead to poor performance and potential pump failure. The only correct fitting to use is a contoured port fitting with an O-ring seal. These are commonly referred to as ORB fittings.



Pump Module I/O:

- **Fuel Outlet** – 6AN ORB (Fitting to factory 3/8 quick connect included)
- **Fuel Return** – 6AN ORB (90° Swivel 6AN ORB to 3/8 Quick Connect fitting included)
- **Vent** – 6AN ORB (Plugged from factory. See instructions below on how to connect to factory EVAP System)

NOTE: If fittings other than the ones that are included are required for your installation, they must be purchased separately. Earl's has a full line of ORB fittings.

Tank Diagram for Reference:

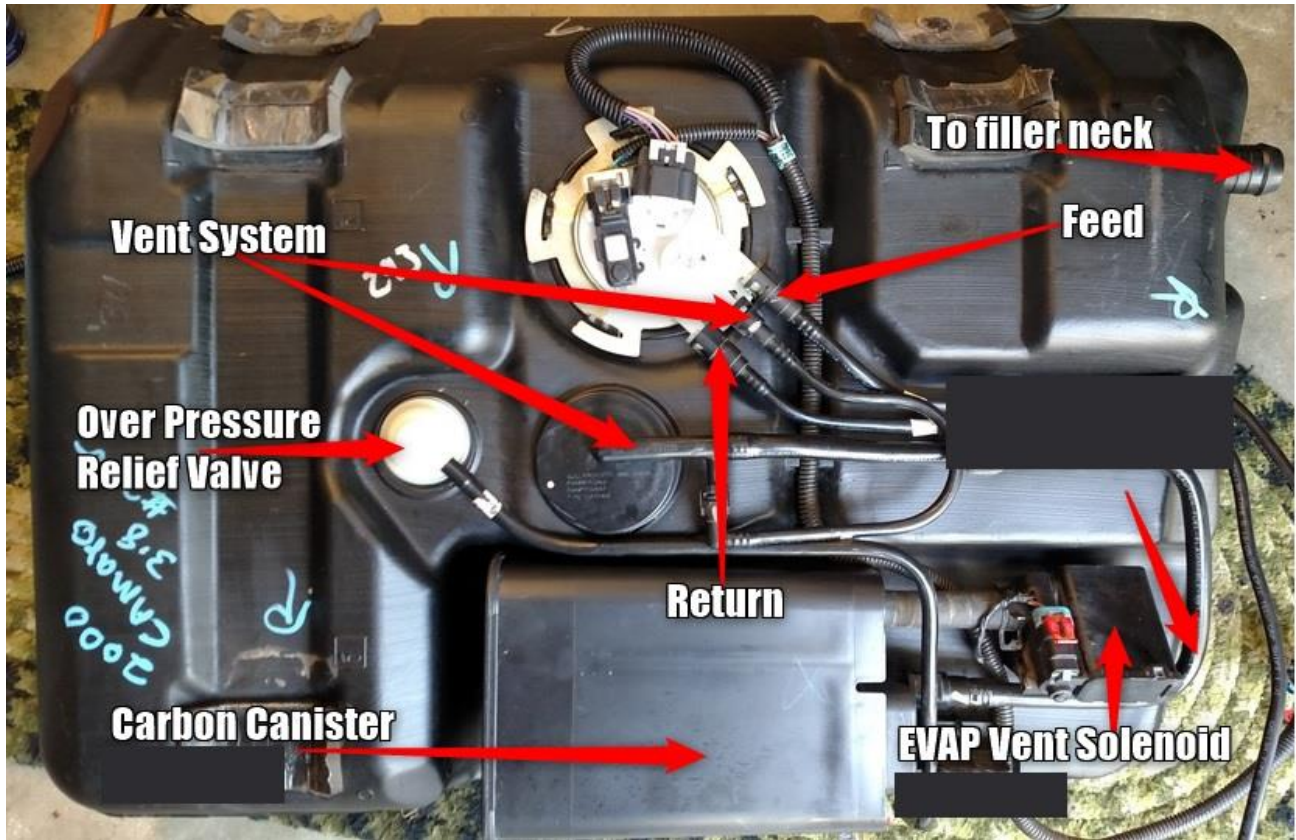

Factory EVAP Connections:

The vent port on the module can be configured to connect to the factory EVAP system with the use of the parts listed below:

- 12-874
- 935056ERL

a. Using a 3/32" hex tool, remove the two fasteners that hold the pump bracket onto the flange.



b. Apply a pipe sealant w/ PTFE to the male 1/8 NPT threads on the 12-874 rollover valve and install it onto the female 1/8 NPT threads on the base of the flange directly under the "vent" port. Then, re-install the pump bracket fasteners.



c. Remove the ORB plug from the “vent” port on the top of the flange using a 1/4” hex tool and install the 935056ERL fitting into the port.

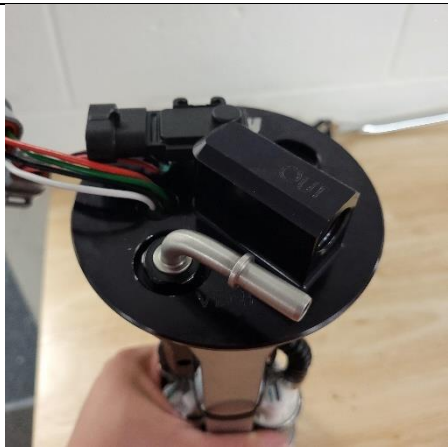

d. After installing the module into the tank, connect the factory vent line to the fitting installed in the previous step.

Installing the Pump Module:

1. Drive the vehicle until the level in the tank is at or below 1/8 of a tank. To make tank removal and reinstall as easy as possible, the lower the fuel level the better.
2. Remove the fuel tank from the vehicle.
3. Cut the supplied return tube to a length of approx. 7.5” then install it onto the empty barb at the base of the flange. Retain the tube with the supplied clamp.
4. Pre-install the HydraMat filters onto the module.

a. If there are plastic washers pre-installed onto the filter socks, do not remove them.

b. Since the tank is angled when installed in the vehicle, it is recommended that the HydraMats be oriented to cover as much of the base of the tank as possible.

NOTE: Be mindful of the sending unit float arm when selecting the orientation of the HydraMats. Be sure that when installed, the float arm can freely move through its full range of motion.



c. Be sure that the filter socks are fully seated onto the outlet and locking stud of each pump. The use of a small dead blow hammer, or other blunt tool, can aid in seating them without causing damage. To the right is a photo of what the filters should look like when properly installed.

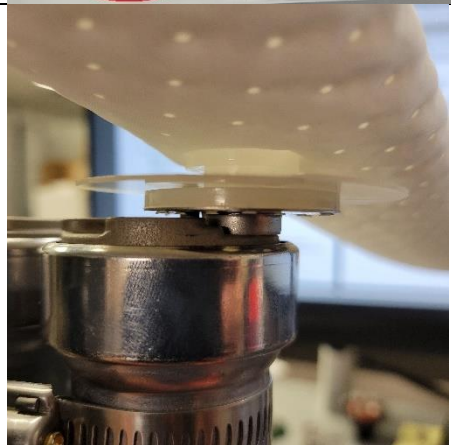

d. An example orientation is shown to the right.

NOTE: For single pump modules, orient the mat so that it is as close to parallel with the top of the tank. This will give you the best coverage of the base of the tank.

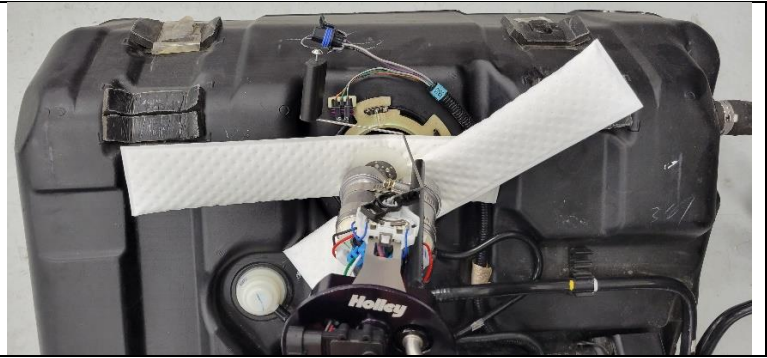

5. Remove the factory fuel pump module from the tank.

a. Remove the factory pump feed, return, and vent lines from the module by pressing in on the locking tabs on each and then pulling the lines off.

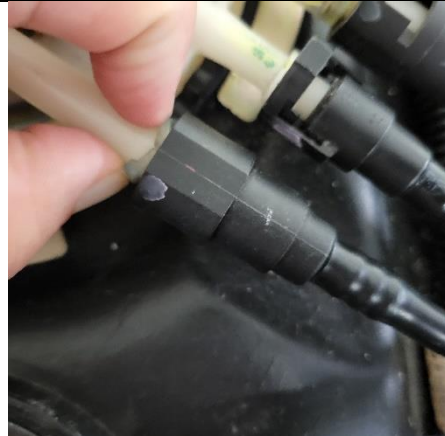

b. Using a brass punch, or other non-sparking tool, remove the fuel pump retaining lock ring.



c. Slowly remove the factory pump module, making sure to not spill any fuel in the process. Also, remove the factory module seal.

6. Install the Holley Module into the Tank (Twin Pump Modules)

The fuel float arm should come detached, but if it is attached to the level sensor, it should be removed at this time.

a. Orient the tank so that the charcoal canister is facing you and the hole for the module is away from you. The tank should naturally want to sit in this orientation.



b. Bend the corners of each HydraMat towards the center of the module. This allows them to be inserted into the tank easily.

NOTE: For single pump modules, this step may not be necessary, since it will be much easier to get the mat in the tank.

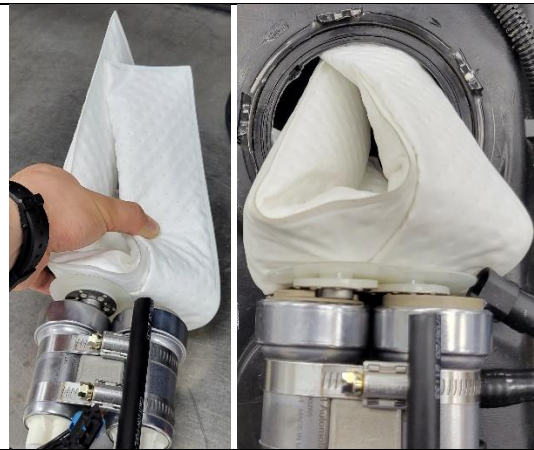

d. Continue inserting the module into the tank until the module is about halfway in. At this point, there should be enough room to insert the float arm into the tank and clip it into the resistor card that is pre-installed on the module.

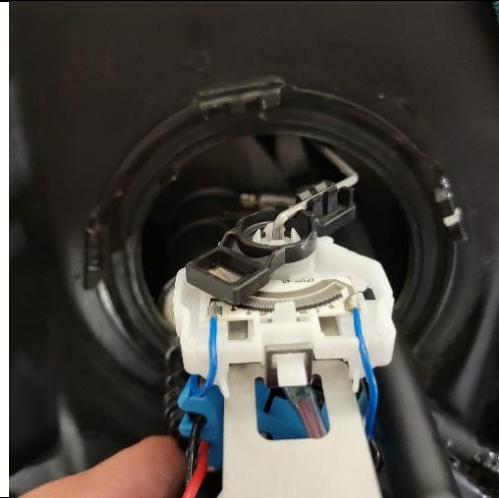

e. Before seating the flange onto the tank, install the new gasket that is included with the module. The gasket is flexible enough that it can be stretched around the flange from the top side and then inserted into its groove in the tank.



f. Align the module, so that the Holley logo is close to parallel with the top of the tank.



<p>g. Re-install the fuel pump lock ring using the same punch that was used to remove it.</p>	
<p>h. Once the lock ring has been re-installed, the tank pressure sensor can be re-oriented so that the connector easily plugs in. If the OEM fuel lines are to be re-used, they can be connected at this time. It is suggested that they be re-oriented as shown.</p>	

Plumbing the Pump Module:

1. Feed Line Options
 - a. Reusing the factory feed line:
 - i. The module has been designed to be able to retain the factory pump feed line and comes with an included straight 3/8 quick connect to -6AN ORB fitting, which can be conveniently installed in the factory location.
 - b. AN plumbing:
 - i. If you wish to run an AN feed line, the module has been designed to accommodate sizes up to -8AN. In this case, an adapter fitting from -6AN ORB to either -6AN male flare or -8AN male flare must be purchased – fittings such as Earls **AT985006ERL** or **AT985086ERL**.
2. Return Line Options
 - a. Reusing the factory return line:
 - i. The module has been designed to retain the factory return line and comes with an included 90° -6AN ORB to 3/8 quick connect fitting.
 - b. AN Plumbing:
 - i. If you wish to run an AN return line, the module has been designed to accommodate sizes up to -8AN. In this case, a 90° forged adapter fitting from -6AN ORB to either -6AN male flare or -8AN male flare must be purchased – fittings such as Earls **AT949006ERL** or **AT949086ERL**.

Wiring your Fuel Pumps:

WARNING! USE A MINIMUM OF 12 GAUGE WIRE. BE SURE TO CRIMP OR SOLDER ALL CONNECTORS SECURELY AND CLEAN ANY AREA WHERE GROUND LEADS WILL BE FASTENED. FAILURE TO USE THE MINIMUM WIRE GAUGE COULD RESULT IN PUMP MALFUNCTION AND/OR ELECTRICAL FIRE, RESULTING IN PROPERTY DAMAGE, SERIOUS INJURY, AND/OR DEATH.

1. Disconnect the cables from the battery.
2. Mount relay/relays in convenient location away from exhaust heat.
3. Plug the fuel pump relay harness into the relay, until it locks into place.

NOTE: Be sure to route all electrical wires clear of any moving suspension or drivetrain components and any exhaust components! Protect wires from abrasion and road obstructions or debris.

Twin Pump Model Connector Wiring

Four Pin Connector Wiring Colors

1. Red – Pump 1 Power
2. White – Pump 2 Power
3. Black – Pump 1 Ground
4. Green – Pump 2 Ground

Two Pin Connector Wiring Colors

1. Red – Resistance 1
2. Black – Resistance 2

Single Pump Model Connector Wiring

Four Pin Connector Wiring Colors

1. Red – Pump Power
2. Black – Pump Ground
3. White – Resistance 1
4. Green – Resistance 2

Wiring the Level Sender:

1. On the factory connector there will be four wires – two thicker 16Ga wires (Black and Gray) and two thinner 18Ga wires (Purple and Black/White). The two thinner wires are the ones we need to splice into. These are for the level sensor.



2. Leaving about 2" of wire attached, cut the square 4-wire connector off. This is done so the connector can be spliced back in if you ever want to re-install a factory fuel pump.



3. Shorten the two resistance wires so that there is approx. 4" of wire extending past the connector, and strip back the wires on both the pigtail and the factory harness. Then, using the included step-down butt connectors, connect the following wires together:

Pigtail Wire Color (Twin Pump)	Factory Harness Color
RED	PURPLE
BLACK	BLACK/WHITE

Pigtail Wire Color (Single Pump)	Factory Harness Color
WHITE	PURPLE
GREEN	BLACK/WHITE

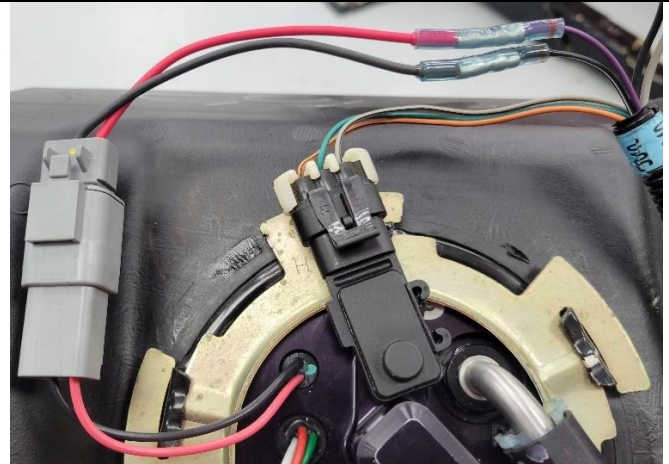

Note: Step down butt connectors are designed to join together wires of different gauges. The side that has the red stripe should be attached to the factory 18Ga harness wires. The other end to the Pigtail wires.



Wiring the Pumps:

1. Disconnect the negative battery terminal and move it out of the way to make sure it cannot accidentally contact the post.



2. Mount the relays – Instructions are written for **Holley P/N 12-759**

a. Remove the (x4) screws on the inner portion of the passenger door sill. The inner trim piece that covers the passenger door sill and footwell can then be removed.



b. Remove the panel covering the spare tire area by removing the three quarter-turn fasteners that hold it in place. Make sure to disconnect the speaker before fully removing the panel.



c. If your vehicle has mounting points in the trunk area, then remove them.



- d. Remove the passenger's side coat hook by releasing the locking tab with a small screwdriver, and then pulling it out. The rear three quarter trim panel can then be removed by pulling on it.



NOTE: The trim panel is held to the vehicle with Dual Lock Tape.

- e. Mount the relays in the approximate location shown behind the seat belt retractor. Be sure to stay clear of the stereo amplifier.



3. Run the heavy gauge red wire that corresponds to pin 30 on each relay to the power stud near the under-hood relay box.

- a. Following the OEM wiring harness, run the wires down the wheel well, and then under the carpet following the door sill to the front passenger footwell.



- b. Remove the OEM ECU by removing the two screws retaining the two connectors, as well as the two screws retaining the ECU to the chassis.



c. Remove the wire pass through grommet then from the inside of the vehicle run the two wires through the hole created.

NOTE 1: The carpet in the passenger wheel well will need to be pulled back slightly.

NOTE 2: Once the wires are in the engine bay where it's easier to work, it is recommended that a small hole be made in the grommet and the wires be run through that hole. This will allow the grommet to be reinstalled.



d. Follow the factory wiring over the wheel well, down towards the battery then across the radiator to the passenger side where there is a stud for power to the fuse box.

NOTE: The wires will more than likely need to be extended by a few feet to reach the stud.



e. In a convenient location between the relay and the fuse box connection, be sure to install a fuse holder and included 30A fuse as shown in the instructions for the 12-759.

NOTE: The kit comes with included step-down butt connectors to go between the heavy gauge wire of the fuse holder and the lighter gauge of the relay wire.

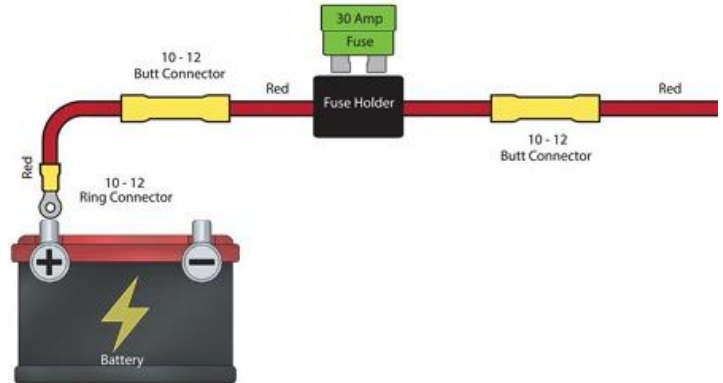

4. Connect the other heavy gauge red wires that correspond to pin 87 on the relay to the power wires for each pump. The RED and WHITE wires (Twin Pump). The RED Wire (Single Pump).

NOTE: There is a convenient grommet in the rear trunk area that leads to the trunk area. It is recommended that this be the pass through you use between the tank and the interior of the vehicle.

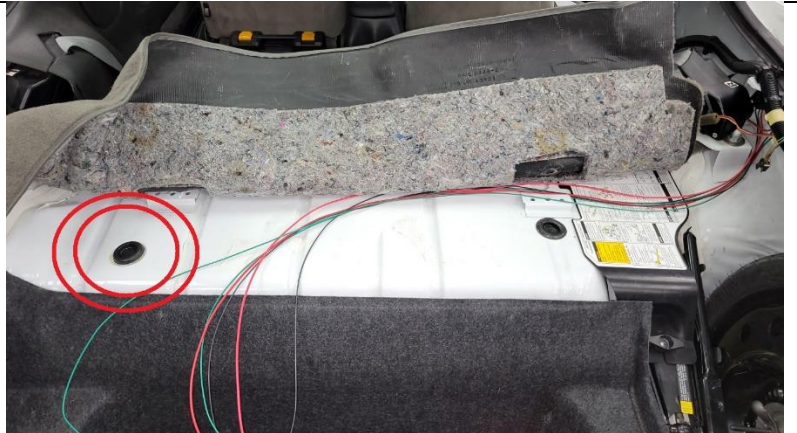

5. Connect the BLACK and GREEN wires (Twin Pump) from the pump harness to a good chassis ground. Just the BLACK wire (Single Pump)

NOTE: It is recommended that the wires be extended and run alongside the factory wiring to the passenger side footwell area where there is a factory ground location just under the dashboard.



Wiring the Switching Circuit for the Relays:

1. Using the included heat shrink butt connectors, connect both light gauge BLACK wires from the relay wiring harnesses to the factory ground wire (heavy gauge BLACK wire from the OEM Pump Connector). Single pump modules will only have one relay wiring harness.
2. The triggering circuit wire for the relay that corresponds to the primary pump (light gauge GREEN wire from the relay harness) should be connected directly to the GRAY wire on the OEM pump connector.
 - a. It is recommended to trigger the wires off of the OEM pump power and ground wires to maintain the crash safety systems that turn the pump off in the event of a crash.
3. The triggering circuit wire for the relay that corresponds to the secondary pump (light gauge GREEN wire from the relay harness) should be connected in one of the ways below:
 - a. Both pumps on all of the time – Wire directly to the OEM heavy gauge GRAY wire from the pump connector.
 - b. Trigger via Hobbs switch for Boosted applications – connect the GREEN trigger wire to one end of the Hobbs switch. The other end should be connected to the GRAY factory pump power wire.

Tank Reinstallation: Once all wiring and plumbing connections have been made, the tank can be reinstalled in the reverse order that it was removed. Make sure to connect both the four-pin and two-pin connectors.

General Notes:

1. It is recommended that a minimum of a ¼ tank of fuel be maintained if the vehicle is going to be used for racing purposes.

Plumbing Safety Instructions:

Once the feed and return plumbing connections have been made, be sure to follow the following instructions to ensure there are no leaks.

1. Once all fuel line connections have been made, re-connect the battery, fill the tank with gas, energize the unit, and check for fuel leaks. If any leaks are found, immediately de-energize the unit and repair them.
 - a. **NOTE: Do not attempt to start the car at this point.**
2. When all leaks have been repaired, cycle the key between the on and off positions a few times to build system pressure. At this point, ensure that the regulator is set to the desired pressure. If not, set the pressure regulator to the desired pressure.
3. Check for leaks once again. If none are found, start the vehicle, and take it for a test drive.
4. Check for leaks one last time and correct any, if found. If none are found, the installation is complete.

CAUTION: Any fuel that is spilled during any part of this installation should be immediately soaked up with shop towels/rags and removed from the vicinity of the vehicle.

Holley® Performance Products, Inc.
1801 Russellville Road
Bowling Green, KY 42101

Technical Support: 1-866-464-6553
Phone: 1-270-781-9741
www.holley.com

© 2023 Holley Performance Products, Inc. All rights reserved. Tous Droits Réservés.

199R12502
Date: 5-16-23