



FENDERS & RELATED

Fenders

Our reproduction fenders are manufactured to duplicate the originals in both fit and appearance. All fenders come EDP coated. Just as with original GM fenders, we recommend test fitting before painting or modifying.

No Volume Discount. All fenders ship Truck Freight to a commercial address. Not eligible for free shipping.



RF-65L 1965 All LH319.95 ea.
RF-65R 1965 All RH319.95 ea.



RF-66L 1966 All LH319.95 ea.
RF-66R 1966 All RH319.95 ea.



RF-67TL 1967 All LH299.95 ea.
RF-67TR 1967 All RH299.95 ea.



RF-68TL 1968 All LH299.95 ea.
RF-68TR 1968 All RH299.95 ea.



RF-69TL 1969 All LH299.95 ea.
RF-69TR 1969 All RH299.95 ea.

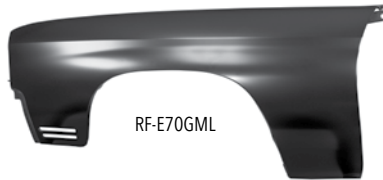

RF-70GML 1970 Chevelle LH269.95 ea.
RF-70GMR 1970 Chevelle RH269.95 ea.
RF-E70GML 1970 El Camino/Wagon LH269.95 ea.
RF-E70GMR 1970 El Camino/Wagon RH269.95 ea.

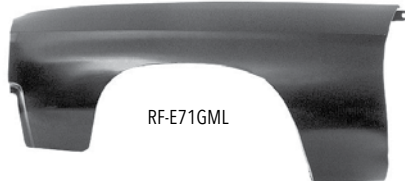

RF-71GML 1971-72 Chevelle LH259.95 ea.
RF-71GMR 1971-72 Chevelle RH259.95 ea.
RF-E71GML 1971-72 El Camino/Wagon LH ...269.95 ea.
RF-E71GMR 1971-72 El Camino/Wagon RH...269.95 ea.
RF-78L 1978-81 Malibu/El Camino LH ...229.95 ea.
RF-78R 1978-81 Malibu/El Camino RH...229.95 ea.
RF-82L 1982-87 Malibu/El Camino LH ...199.95 ea.
RF-82R 1982-87 Malibu/El Camino RH...199.95 ea.



Fender Kits

These kits include a pair of fenders at a great price!

RF-65TK 1965 All 575.91 kit
RF-66TK 1966 All 559.00 kit
RF-67TK 1967 All 539.99 kit
RF-68TK 1968 All 559.95 kit
RF-69TK 1969 All 529.95 kit
RF-70TK 1970 All 539.90 kit
RF-712TK 1971-72 All 519.90 kit



Lower Fender Support Braces

These lower fender braces connect the lower fenders to the radiator support for rigidity. Includes hardware.

RFB-3900 1964-72 All 24.95 pr.



Inner Fender to Radiator Support Brackets

This is a pair of 1970 Chevelle inner fender to radiator support brackets which are stamped from heavy gauge steel as original.

RSB-3470 1970 All 34.99 pr.



Front Inner Fenders

Brand new die-stamped inner fender wells.

RIF-65L 1965 All LH 119.95 ea.
RIF-65R 1965 All RH 119.95 ea.
RIF-66AL 1966 All LH 109.95 ea.
RIF-66AR 1966 All RH 109.95 ea.
RIF-66AK 1966 All Pair 197.91 kit
RIF-67AL 1967 All LH 109.95 ea.
RIF-67AR 1967 All RH 109.95 ea.
RIF-67AK 1967 All Pair 197.91 kit
RIF-68SL 1968-72 All LH 109.99 ea.
RIF-68SR 1968-72 All RH 109.99 ea.
RIF-68KIT 1968-72 All Pair 197.98 kit
RIF-73P 1973-77 All Plastic 249.95 pr.
RIF-78EM 1978-87 El Camino, 78-83 Malibu ... 319.99 pr.
BIF-64K Hardware Kit 26.95 ea.
RIFS-787 1978-80 All Inner Fender Shields 44.95 pr.

Ships Oversize 2. Not eligible for free shipping.



RFP-702L

Fender Patches

High quality fender patches for this commonly rusted area.

RFP-64L 1964-65 All LH 44.95 ea.
RFP-64R 1964-65 All RH 44.95 ea.
RFP-66L 1966-67 All LH 44.95 ea.
RFP-66R 1966-67 All RH 44.95 ea.
RFP-89L 1968-69 Chevelle LH 39.95 ea.
RFP-89R 1968-69 Chevelle RH 39.95 ea.
RFP-702L 1970-72 Chevelle LH 49.95 ea.
RFP-702R 1970-72 Chevelle RH 49.95 ea.
RFP-89L 1968-72 El Camino LH 39.95 ea.
RFP-89R 1968-72 El Camino RH 39.95 ea.



FRONT END SHEET METAL



RRS-65



RRS-68-HQHD

Radiator Supports

Reproduction radiator supports.

RRS-65	1965 All	189.95 ea.
RRS-66R	1966 All	124.95 ea.
RRS-667	1967 All	124.95 ea.
RRS-089	1968-69 All	129.95 ea.
RRS-07M	1970 All	129.95 ea.
RRS-712	1971-72 All	124.95 ea.
RRS-8188	1981-88 Monte Carlo	399.99 ea.
RSB-1330	1981-88 Monte Carlo 3 pc Support Brace Kit	79.95 kit

These high quality supports are made of the finest steel and tooling. They are made as original and would be a great addition to any restoration.

RRS-68-HQHD	1968 All, HD Cooling	169.99 ea.
RRS-69-HQHD	1969 All, HD Cooling	169.99 ea.
RRS-70-HQHD	1970 All, HD Cooling	169.99 ea.
RRS-712-HQHD	1971-72 All, HD Cooling	169.99 ea.

No Volume Discount. Ships Oversize 2. Not eligible for free shipping.

Radiator to Frame Brackets

Replacement for the hard to find brackets which the radiator support bushings mount to. Stamped from heavy gauge steel as original.

RRS-7SB



RRS-7SB	1970-72	69.99 pr.
---------	---------------	-----------



BFE-8002



Front End Fastener Kit

Over 175 pieces all individually bagged to attach all of your front end sheet metal including fenders, grille, inner fenders, hood, etc.

BFE-8001	1964-67 All	55.99 kit
BFE-8002	1968-72 All	55.99 kit

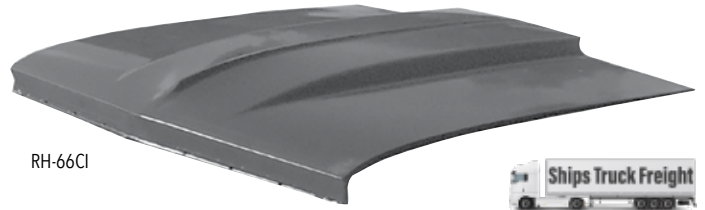

RH-66CI



Cowl Induction Hoods

These are the hoods that GM should have made! Let people know your ride means business with one of these 2" cowl hoods!

RH-66CI	1966 All	349.99 ea.
RH-67CI	1967 All	349.99 ea.
RH-68CI	1968-69 All	349.99 ea.
RH-812	1981-88 Monte Carlo 2" Cowl	339.99 ea.
RH-814FG	1981-88 Monte Carlo 2" Cowl Fiberglass	575.99 ea.
RH-872	1978-88 Buick Regal GN 2" Cowl	399.99 ea.
RH-8187-2	1978-88 Malibu/ El Camino 2" Cowl	395.95 ea.

No Volume Discount. Ships Truck Freight to a commercial address. Not eligible for free shipping. Use 1969 hinges with 1968-69 hoods.



RH-65

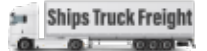

1965 Chevelle Hood

This is a reproduction of the nearly impossible to find 1965 Chevelle flat hood. This hood is a perfect replacement for your damaged original so you will no longer have to search the junkyards and swap meets for a decent hood.

RH-65	1965 All	359.99 ea.
-------	----------------	------------

No Volume Discount. Ships Truck Freight to a commercial address. Not eligible for free shipping.

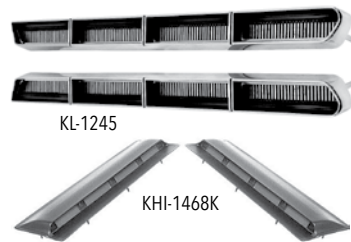

KL-1245

KHI-1468K



RH-66SS

1966 Chevelle Hoods

Reproduction die-stamped flat hoods and Super Sport hoods.

RH-66SSKIT	1966 SS Hood w/ Ornaments	485.87 kit
RH-66SS	1966 Super Sport Hood Only	269.95 ea.
KHI-1468K	1966 Ornament Housings Only	169.95 pr.
KL-1245	1966 Ornament Inserts Only	99.95 pr.
RH-66M	1966 Standard	269.95 ea.

No Volume Discount. Ships Truck Freight to a commercial address. Not eligible for free shipping.



BUY'N SAVE WITH KITS

1967 Chevelle Hoods

Reproduction die-stamped Super Sport hood.

- RH-67SSKIT 1967 SS Hood w/ Ornaments359.95 kit
- RH-67SSKITH SS Hood w/ Ornaments, & Front Edge Molding.....400.40 kit
- RH-67SS 1967 Super Sport Hood Only.....299.99 ea.
- KC-1255 1967 Louvers Only.....99.95 pr.

No Volume Discount. Ships Truck Freight to a commercial address. Not eligible for free shipping.



BUY'N SAVE WITH KITS

1968-69 Chevelle Hoods

Reproduction die-stamped Super Sport hood.

- RH-68SSKIT 1968-69 SS Hood w/ Ornaments341.95 kit
- RH-68SS 1968-69 Super Sport Hood Only279.95 ea.
- NL-100 1968-69 Louvers Only99.99 pr.

Use 1969 hinges for 1968.

No Volume Discount. Ships Truck Freight to a commercial address. Not eligible for free shipping.



1970-72 SS Domed Chevelle Hood

Reproduction die-stamped Super Sport hood.

- RH-702 1970-72 All w/o Cowl Induction274.95 ea.



1970-72 Chevelle Hoods

Reproduction die-stamped Super Sport or Cowl Induction hoods.

- RH-70RK 1970-72 SS Cowl Hood Kit.....596.20 kit
- RH-70R 1970-72 All Cowl Induction Hood274.95 ea.
- ACX-970 1970-72 Outer Cowl Door Kit116.71 kit
- HPK-100 1970-72 Complete Hood Pin Set.....29.95 kit
- MSS-2970 1970-72 SS Stripe Stencil Kit.....42.95 kit

No Volume Discount. Ships Truck Freight to a commercial address. Not eligible for free shipping.

Hood Hinge Kit 1968-72 Repro Style

These are high quality reproduction hood hinges complete with springs and featuring a black EDP coating.

- RHG-68KWS 1968 All LH & RH109.95 kit
- RHG-69KWS 1969 All LH & RH109.95 kit
- RHG-70KWS 1970-72 All LH & RH.....109.95 kit
- BPA-381 3/8" x 1" Bolt0.65 ea.

Note: Bolts are not included.



OE Style Pre-Assembled Hood Hinges

These hood hinges are for the purist who won't settle for anything less than the best! Sold each or as a set of left and right hinges with the correct springs pre-installed. They feature an OE correct black phosphate coating just like the OEM.

- RHG-142WSK 1965-67 All LH & RH 89.91 ea.
- RHG-142WSL 1965-67 All LH49.95 ea.
- RHG-142WSR 1965-67 All RH49.95 ea.
- RHG-996K 1968 All LH & RH179.99 kit
- RHG-996L 1968 All LH89.99 ea.
- RHG-996R 1968 All RH89.99 ea.
- RHG-997K 1969 All LH & RH179.99 kit
- RHG-997L 1969 All LH89.99 ea.
- RHG-997R 1969 All RH89.99 ea.
- RHG-998K 1970-72 All LH & RH179.99 kit
- RHG-998L 1970-72 All LH89.99 ea.
- RHG-998R 1970-72 All RH89.99 ea.
- BPA-381 3/8" x 1" Bolt.....0.65 ea.

Note: Bolts are not included.

Hood Hinges

High quality reproduction hood hinges.

- RHG-64L 1964 All LH.....44.95 ea.
- RHG-64R 1964 All RH44.95 ea.
- RHG-142L 1965-67 All LH39.95 ea.
- RHG-142R 1965-67 All RH.....39.95 ea.
- RHG-667L 1965-67 All LH
Licensed GM Resto 119.99 ea.
- RHG-667R 1965-67 All RH
Licensed GM Resto 119.99 ea.
- RHG-68L 1968 All LH.....39.95 ea.
- RHG-68R 1968 All RH39.95 ea.
- RHG-69L 1969 All LH.....39.95 ea.
- RHG-69R 1969 All RH39.95 ea.
- RHG-70L 1970-72 All LH39.95 ea.
- RHG-70R 1970-72 All RH.....39.95 ea.
- RHG-73L 1973-77 All LH69.95 ea.
- RHG-73R 1973-77 All RH.....69.95 ea.
- RHS-642 1964-77 Hood
Hinge Spring.....15.95 ea.
- RHG-818L 1981-88
Monte Carlo LH.....79.95 ea.
- RHG-818R 1981-88
Monte Carlo RH.....79.95 ea.





Eddie Motorsports Billet Hood Hinges

These billet hood hinges are machined from 6061-T6 aluminum and will add an awesome custom touch to your engine compartment. They Bolt-in and require no cutting of your sheet metal. Complete with stainless steel nitrogen gas shocks and all stainless steel fasteners.

M = Machined
P = Polished
R = Red Fusioncoat
B = Blue Fusioncoat

W = White Fusioncoat
PR = Purple Fusioncoat
BK = Gloss Black Fusioncoat
BKA = Gloss Black Anodized

MB = Matte Black Fusioncoat
MBA = Matte Black Anodized
CL = Clear Coat
CA = Clear Anodized



M P R, B, W, PR, BK, BKA, MB, MBA, CL, CA

MS149-56	1964 All	580.99 pr	635.99 pr	690.99 pr
MS149-55	1965-67 All	580.99 pr	635.99 pr	690.99 pr
MS149-58	1968 All	615.99 pr	665.99 pr	720.99 pr
MS149-57	1969-72 All	615.99 pr	665.99 pr	720.99 pr

*One year warranty.



Hood Latch Support

Correct support that runs vertically and attaches to the radiator support.

RVL-65A	1965 All	32.95 ea.
RVL-66A	1966 All	32.95 ea.
RVL-67A	1967 All	32.95 ea.
RVL-68	1968 All	32.95 ea.
RVL-69	1969 All	32.95 ea.
RVL-70A	1970 All	32.95 ea.
RVL-1488G	1971-72 All	34.95 ea.



Hood Release Handle

Reproduction of this often missing or broken pull handle.

RHR-70X	1970-72 All	24.95 ea.
---------	-------------	-----------



1964-1972 Hood Release

Reproduction hood release assemblies

RHL-65	1964-65 All	49.95 ea.
RHL-66	1966 All	69.95 ea.
RHL-67	1967 All	69.95 ea.
RHL-68	1968 All	74.95 ea.
RHL-69	1969 All	77.99 ea.
RHR-59	1970-72 All	84.95 ea.



Billet Hood Hinges

Give your engine bay a custom touch with these affordable billet hood hinges! These hood hinges come complete with heavy duty struts and hardware. Sold as a pair with hardware.

RHG-BH11	1965-67 All	499.95 kit
RHG-BH12	1968 All	499.95 kit

No Volume Discount.



Eddie Motorsports Billet Hood Latch Assembly

CNC machined from a solid chunk of 6061-T6 aluminum and stainless steel. This is a direct replacement for your cheap stock stamped steel hood latch. The EMS billet hood latch kit comes complete with a billet aluminum base plate and billet stainless steel pilot bolt and retaining cup. Stainless steel fasteners and billet aluminum finishing washers are also included.

M = Machined Fusioncoat
P = Polished
R = Red
B = Blue Fusioncoat
W = White Fusioncoat

PR = Purple Fusioncoat
BK = Gloss Black Fusioncoat
BKA = Gloss Black Anodized
MB = Matte Black Fusioncoat
MBA = Matte Black Anodized



CL = Clear Coat
CA = Clear Anodized

		M	P	R, B, W, PR, BK, BKA, MB, MBA, CL, CA
MS276-20	1965	138.99 ea.	160.99 ea.	172.99 ea.
MS276-21	1966	138.99 ea.	160.99 ea.	172.99 ea.
MS276-15	1967	138.99 ea.	160.99 ea.	172.99 ea.
MS276-10	1968-69	126.99 ea.	149.99 ea.	167.99 ea.
MS276-12	1970-72	138.99 ea.	160.99 ea.	172.99 ea.



Hood Catch

Correct catch which mounts on underside of hood.

RHR-64	1964 All	39.95 ea.
RHR-66	1966 All	34.95 ea.
RHR-67	1967 All	39.99 ea.
RHR-L70	1970-72 All	34.95 ea.
RHR-70	1970-72 All OE Style	49.99 ea.



Hood Pin Kit OE Style

This is a set of OE style reproduction hood pins which were originally found on Super Sport models. Each kit includes (2) pins, (2) plates, (2) gaskets, (2) cables and all necessary hardware.

HPK-100	1970-72 SS	29.95 kit
---------	------------	-----------

No Volume Discount.



Hood Pin Kit - Hair Pin Style

Universal chrome hood pin kit for use on any vehicle.

GCS-S4051	All	10.99 kit
-----------	-----	-----------

HPK-CHROME

HPK-BLACK

Billet Aluminum Hood Pin Kits Peel N Stick

These hood pin kits are a great way to add that protouring/ racing look without drilling or cutting your hood. The pin mounts are either chrome plated or black aluminum with chrome pins and feature rubber coated cables. They attach with high quality double sided 3M adhesive tape.

HPK-CHROME	Chrome All	29.99 kit
HPK-BLACK	Black All	26.99 kit



Dash Top Panel

Complete dash top panel which is a great replacement for this commonly rotted out area.

RDP-66A	1966	259.99 ea.
RDP-67A	1967	259.99 ea.

Ships Oversize.



Splash Panel/Filler Panel

This panel fills the gap behind the bumper and ties the front end together.

RVP-65F	1965 3pc	69.95 kit
RVP-4031	1966 All	69.95 ea.
RVP-2150	1967 All	69.95 ea.
RVP-68	1968 All	69.95 ea.
RVP-92	1969 All	69.95 ea.
RVP-A70	1970 All	69.95 ea.

Ships Oversize. Not eligible for free shipping.



Header Panel

Reproduction of this often damaged front edge header molding.

RHP-689A	1968-69 All	134.95 ea.
RHP-82	1982-87 Malibu/El Camino	149.95 ea.

Ships Oversize. Not eligible for free shipping.



Front Fender Tie Brace

Correct steel panel that ties the top of the fenders together.

RTB-65	1965 Upper Grille Plate All	72.95 ea.
RTB-1487ZB	1967 Upper Grille Plate All	72.95 ea.
RTB-70	1970-72 All	69.95 ea.

Ships Oversize. Not eligible for free shipping.



1964-67 Cowl Panel

Louvered piece of sheet metal installs directly below the windshield behind the hood.

RCP-64	1964-67 All	169.95 ea.
--------	-------------	------------



Firewalls

Brand new complete firewalls.

RFP-66A	1964-67 Firewall w/o AC*	319.99 ea.
RFP-1461IA	1964-67 Firewall Heater Delete	329.95 ea.
RFP-1461A	1968-72 Firewall w/ AC	329.95 ea.
RFP-1461H	1968-72 Firewall Convertible w/ AC	329.95 ea.
RFP-1461B	1968-72 Firewall w/o AC	329.95 ea.
RFP-1461C	1968-72 Firewall Heat erDelete	329.95 ea.
RWP-1461G	1968-69 Firewall Wiper Plate	32.95 ea.

Ships Truck Freight to a commercial address. Not eligible for free shipping. No Volume Discount.
 * Correct for 1966-67. Can be modified to fit 1964-65.



Firewall Brackets

Reproduction firewall brackets (where your body bushings attach).

RFP-1461F	1968-72 Coupe	109.95 pr.
RFP-1461-VL	1968-72 Convertible LH	59.95 ea.
RFP-1461-VR	1968-72 Convertible RH	59.95 ea.



Dash Repair/Windshield Channel

This new repair panel replaces the often rusted out area where the base of the windshield and dash come together. This panel runs the full length of the dash.

RDP-430	1964-67 All	49.95 ea.
RDP-1424A	1968-72 w/ Pre-Welded Brackets	89.95 ea.
RDP-3468	1968-72 w/ Brackets (Not Attached)	99.99 ea.

**May require some modification for 1968-69. Ships Oversize. Not eligible for free shipping.*



Fender to Firewall Brackets

These brackets provide the mounting points for the fenders.

RFB-3468	1968-72 All	53.99 pr.
----------	-------------	-----------

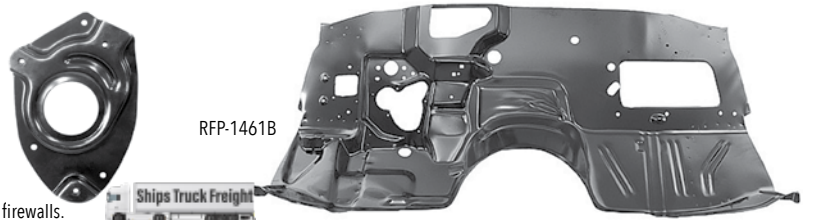

DOOR & RELATED



RDS-66AR

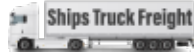

Door Skins

Door skins are perfect for repairing doors that have not rusted through the inner shell. These stamped steel panels replace your old rusty skin.

RDS-65AL	1964-65 Chevelle/El Camino LH.....	136.95 ea.
RDS-65AR	1964-65 Chevelle/El Camino RH.....	136.95 ea.
RDS-66AL	1966-67 Chevelle/El Camino LH.....	144.95 ea.
RDS-66AR	1966-67 Chevelle/El Camino RH.....	144.95 ea.
RDS-68AL	1968 Chevelle LH.....	136.95 ea.
RDS-68AR	1968 Chevelle RH.....	136.95 ea.
RDS-69AL	1969 Chevelle LH.....	136.95 ea.
RDS-69AR	1969 Chevelle RH.....	136.95 ea.
RDS-70AL	1970-72 Chevelle LH.....	136.95 ea.
RDS-70AR	1970-72 Chevelle RH.....	136.95 ea.
RDS-68EL	1968-72 El Camino LH.....	159.95 ea.
RDS-68ER	1968-72 El Camino RH.....	159.95 ea.
RDS-78L	1978-85 Malibu/El Camino LH.....	179.95 ea.
RDS-78R	1978-85 Malibu/El Camino RH.....	179.95 ea.
RDS-81GNL	1980-87 Regal Cutlass LH.....	194.99 ea.
RDS-81GNR	1980-87 Regal Cutlass RH.....	194.99 ea.
RDS-81MCL	1981-85 Monte Carlo LH.....	209.95 ea.
RDS-81MCR	1981-85 Monte Carlo RH.....	209.95 ea.
RDS-86EL	1986-87 El Camino LH.....	194.95 ea.
RDS-86ER	1986-87 El Camino RH.....	194.95 ea.
RDS-86MCL	1986-88 Monte Carlo LH.....	209.99 ea.
RDS-86MCR	1986-88 Monte Carlo RH.....	209.99 ea.

No Volume Discount. Ships Oversize 2. Not eligible for free shipping.



RSH-66L



Door Shells

These full door shells feature the outer door skin welded to the shell as original. Perfect when your entire door has rusted through.

RSH-64L	1964-65 Chevelle LH.....	399.95 ea.
RSH-64R	1964-65 Chevelle RH.....	399.95 ea.
RSH-66L	1966-67 Chevelle/El Camino LH.....	325.95 ea.
RSH-66R	1966-67 Chevelle/El Camino RH.....	325.95 ea.
RSH-68AL	1968 Chevelle LH.....	325.95 ea.
RSH-68AR	1968 Chevelle RH.....	325.95 ea.
RSH-69AL	1969 Chevelle LH.....	325.95 ea.
RSH-69AR	1969 Chevelle RH.....	325.95 ea.
RSH-70AL	1970-72 Chevelle LH.....	329.95 ea.
RSH-70AR	1970-72 Chevelle RH.....	329.95 ea.
RSH-78L	1978-85 Malibu/El Camino LH.....	469.99 ea.
RSH-78R	1978-85 Malibu/El Camino RH.....	469.99 ea.
RSH-81GNL	1978-85 Regal Cutlass LH.....	494.99 ea.
RSH-81GNR	1978-85 Regal Cutlass RH.....	494.99 ea.
RSH-81MCL	1981-85 Monte Carlo LH.....	499.95 ea.
RSH-81MCR	1981-85 Monte Carlo RH.....	499.95 ea.
RSH-86EL	1986-87 El Camino LH.....	469.95 ea.
RSH-86ER	1986-87 El Camino RH.....	469.95 ea.
RSH-86MCL	1986-88 Monte Carlo LH.....	489.99 ea.
RSH-86MCR	1986-88 Monte Carlo RH.....	489.99 ea.

No Volume Discount. Ships Truck Freight to a commercial address. Not eligible for free shipping.

Door Hinge Hardware

Correct OEM bolts and heavy spring.

BAV-2622	1964-67 Phillips.....	1.99 ea.
BAV-2623	1964-72 Hex.....	1.99 ea.
RHS-9	1964-72 Spring.....	8.99 ea.
BAV-2622K	Phillips (6 pc.) Hex (18 pc.).....	40.60 kit
BAV-2623K	Hex (24 pc.).....	40.60 kit



RHS-9

BAV-2623
BAV-2622

BPX-1225



Door Hinge Pin Kits

Correct hinge pins and brass bushings for repairing all 4 of your door hinges.

BPX-1225	1966-67 (12 pc.).....	14.95 ea.
BPX-2225	1968-72 (12 pc.).....	13.99 ea.

*May require slight modification to hinges.

Cowl Shoulder Assembly

Complete replacement for this often rotted out area.

RCS-66L	1966-67 LH.....	149.99 ea.
RCS-66R	1966-67 RH.....	149.99 ea.
RCS-68L	1968-72 LH.....	123.95 ea.
RCS-68R	1968-72 RH.....	123.95 ea.

RCS-68R



1966-67 Cowl Side Outer - Front Panel

RCP-66L	1966-67 LH.....	79.99 ea.
RCP-66R	1966-67 RH.....	79.99 ea.

1966-67 Cowl Front Panel

RCP-66AFL	1966-67 LH.....	79.99 ea.
RCP-66AFR	1966-67 RH.....	79.99 ea.

1968-72 Cowl Side Panel

RCP-7L	1968-72 LH.....	63.95 ea.
RCP-7R	1968-72 RH.....	63.95 ea.



RCP-66AFL

RCP-66L

RCP-7L



RDH-66AR

RDH-66AL

Door Hinge Pillar Assembly

Complete door hinge pillar assembly which provides the mounting points for the door hinges.

RDH-66AL	1966-67 LH.....	229.99 ea.
RDH-66AR	1966-67 RH.....	229.99 ea.

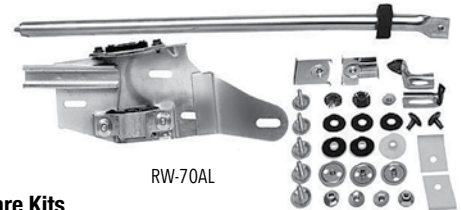

RW-70AL

Window Track And Hardware Kits

This convenient door window track & hardware kit is great for when you are changing out your door glass.

RW-70AL	1970-72 Chevelle LH.....	195.95 set
RW-70AR	1970-72 Chevelle RH.....	195.95 set

Ships Oversize. No Volume Discount.



RDR-72K

RDR-67

Hinge Detent Rollers

Correct machined detent rollers for lower hinges.

RDR-67	1965-67 All.....	16.95 kit
RDR-72K	1968-72 All.....	26.99 kit



Door Hinges

Reproduction door hinges. Buy the complete set of four and save 10%.

Upper

RDH-64U	1964-65 LH/RH	49.95 ea.
RDH-529U	1966-67 LH/RH	49.95 ea.
RDH-170U	1968-72 LH/RH	59.95 ea.
RDH-78UL	1978-88 All LH	69.95 ea.
RDH-78UR	1978-88 All RH	69.95 ea.

Lower

RDH-2590	1964-65 LH	54.95 ea.
RDH-2595	1964-65 RH	54.95 ea.
RDH-346LL	1966-67 LH	49.95 ea.
RDH-346LR	1966-67 RH	49.95 ea.
RDH-088LL	1968-72 LH	59.95 ea.
RDH-088LR	1968-72 RH	59.95 ea.
RDH-78L	1978-88 All LH/RH	59.95 ea.



RDL-SCREW



RDL-70AR

Door Latch Assemblies

Reproduction door latch assemblies.

RDL-1543L	1964-65 LH	69.95 ea.
RDL-1542R	1964-65 RH	69.95 ea.
RDL-67AL	1966-67 LH	69.95 ea.
RDL-67AR	1966-67 RH	69.95 ea.
RDL-67AK	1966-67 Kit (Both Sides).....	111.92 kit
RDL-68AL	1968 LH	69.95 ea.
RDL-68AR	1968 RH	69.95 ea.
RDL-68AK	1968 Kit (Both Sides).....	111.92 kit
RDL-69AL	1969 LH	69.95 ea.
RDL-69AR	1969 RH	69.95 ea.
RDL-69AK	1969 Kit (Both Sides).....	111.92 kit
RDL-70AL	1970-72 LH	69.95 ea.
RDL-70AR	1970-72 RH	69.95 ea.
RDL-70AK	1970-72 Kit (Both Sides).....	111.92 kit
RDL-828L	1982-88 All LH	49.99 ea.
RDL-828R	1982-88 All RH	49.99 ea.
RDL-SCREW	1964-77 Screw 3 pc*	6.95 set

*Part Notes: This kit does one door latch. One kit required per door.

Door Strikers w/ Washer



BPX-1275



BPX-1299

BPX-1275	GM Replacement	9.99 ea.
BPX-1299	Reproduction*	11.99 ea.
BPX-1299K	Reproduction Pair	20.38 kit

*Correct Allen Head Zinc Plated.

ROOF PANEL & RELATED

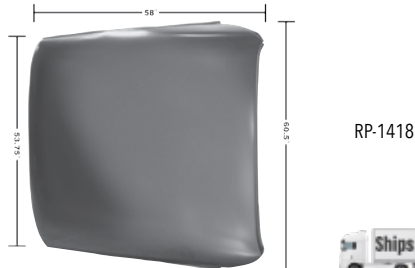

RP-1418

Roof Panel

Full replacement roof panel for your Chevelle or El Camino. Don't forget to add the braces!

RP-66A	1966-67 Chevelle	449.99 ea.
RP-1418	1968-72 Chevelle	369.95 ea.
RP-1428E	1968-72 El Camino	339.95 ea.
RTT-7888	1978-88 Monte T-Top Trim	309.99 set

Ships Truck Freight to a commercial address. Not eligible for free shipping. No Volume Discount.



RPB-1418A

Roof Panel Braces

Correct roof panel braces for replacing damaged originals.

RPB-1418A	1970-72 Chevelle	199.95 kit
-----------	------------------------	------------

(Includes all braces & wire bows for complete replacement.)

RPB-1428EA	1968-72 El Camino.....	229.95 kit
------------	------------------------	------------

(Includes front, middle and rear braces.)



RIB-1418P

Roof Panel Inner Brace Kit

These braces provide the proper mounting points for the bows.

RIB-1418U	1964-65 Chevelle	209.95 kit
RIB-1418P	1968-72 Chevelle	244.95 kit
RPB-1418T	1968-72 El Camino.....	229.95 kit

(Includes front corners, rear corners and side roof braces.)

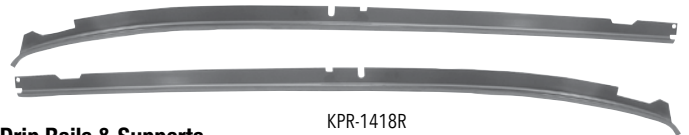

KPR-1418R

Drip Rails & Supports

New steel drip rails which your moldings attach to and vertical drip rail supports which attach to the A-pillars.

KPR-667	1966-67 Chevelle Roof Drip Rails.....	199.99 pr.
KPR-1418N	1968-72 Chevelle Drip Rail Pillar Supports	55.95 pr.
KPR-1418R	1968-69 Chevelle Roof Drip Rails.....	119.95 pr.
KPR-1418S	1970-72 Chevelle Roof Drip Rails.....	139.99 kit
KPR-M1429B	1964-67 El Camino A-Pillar RH	89.99 ea.
KPR-M1429C	1964-67 El Camino A-Pillar LH.....	89.99 ea.

Ships Oversize. Not eligible for free shipping.

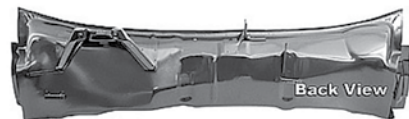

RCP-1419WT

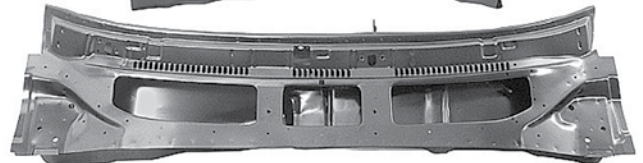

1968-72 Cowl Panel

This lower cowl panel offers a complete replacement for this often rotted out area. This complete cowl panel includes the entire wiper valley so you can be sure to eliminate any rust or rot all in one shot.

RCP-1419AWT	1968-69	369.95 ea.
RCP-1419WT	1970-72	369.95 ea.

Ships Oversize 2. Not eligible for free shipping.

WINDSHIELD & COWL



RLC-66AU

RLC-66AL

1966-67 Lower Cowl

Great replacement for this commonly rotted out lower cowl area.

RLC-66AL	1966-67 Lower.....	229.99 ea.
RLC-66AU	1966-67 Upper.....	154.99 ea.

Ships Oversize.

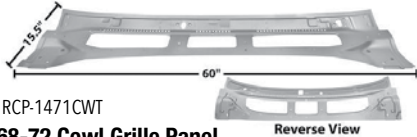

RCP-1471CWT

Reverse View

1968-72 Cowl Grille Panel

Reproduction perfect for replacing this commonly rotted area. Features Weld-Thru primer.

RCP-69-TOP	1968-69.....	199.95 ea.
RCP-1471CWT	1970-72.....	199.95 ea.

Ships Oversize 2.



RDP-1455

Steel Dash Panel

This is a reproduction of the steel dash panel for Chevelle and El Camino.

RDP-1455	1968 All.....	369.95 ea.
----------	---------------	------------

Oversize 2. No Volume Discount. Not eligible for free shipping.



IXM-68L

IXM-68R

Windshield Pillar Moldings

IXM-68L	1968-72 Coupe Steel LH.....	129.95 ea.
IXM-68R	1968-72 Coupe Steel RH.....	129.95 ea.
IXM-68K	1968-72 Coupe Steel Pair.....	239.95 kit



RWP-66AIL

Windshield Pillar

Inner windshield pillar replacement used to replace this common rust area.

RWP-66AIL	1966-67 Inner LH.....	109.99 ea.
RWP-66AIR	1966-67 Inner RH.....	109.99 ea.
RWP-682AL	1968-72 Outer LH.....	88.99 ea.
RWP-682AR	1968-72 Outer RH.....	88.99 ea.



RPW-1461J

Windshield Pillar Wrap

This piece of sheet metal is used to wrap the outside of the windshield pillar and measures approximately 26 inches long by 7 inches wide at the base.

RPW-1461K	1966-67 LH.....	109.99 ea.
RPW-1461J	1966-67 RH.....	109.99 ea.

ARCH & WHEELHOUSE



RWB-1418AA

Windshield Frame Bridge

This convertible windshield frame bridge sits above the windshield and provides the mounting points for the visors, rear view mirror and top molding.

RWB-1418AA	1970-72 Convertible.....	169.95 ea.
------------	--------------------------	------------



RWA-64L

Wheel Arch Patches

High quality wheel arch patch. Perfect for replacing the commonly rotted out area around the wheel opening.

Chevelle

RWA-64L	1964-65 All LH.....	49.95 ea.
RWA-64R	1964-65 All RH.....	49.95 ea.
RWA-66L	1966-67 All LH.....	49.95 ea.
RWA-66R	1966-67 All RH.....	49.95 ea.
RWA-68L	1968-69 All LH.....	49.95 ea.
RWA-68R	1968-69 All RH.....	49.95 ea.
RWA-70L	1970-72 All LH.....	49.95 ea.
RWA-70R	1970-72 All RH.....	49.95 ea.

G-Body

RWA-818L	1981-88 Olds Cutlass 442 LH.....	69.99 ea.
RWA-818R	1981-88 Olds Cutlass 442 RH.....	69.99 ea.
RWA-817L	1981-88 Buick Regal GN LH.....	79.99 ea.
RWA-817R	1981-88 Buick Regal GN RH.....	79.99 ea.

Quarter Plug

Correct plug and orange gasket used to plug the rear quarter panel drain hole.

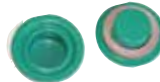

BPP-70Q	1970-72.....	20.99 pr.
---------	--------------	-----------



R-1472S

Complete Chevelle Wheelhouse Assemblies

These complete wheelhouse assemblies feature the inners and outers already welded together, saving you a lot of time and money!

R-1472S	1970-72 Coupe LH.....	199.95 ea.
R-1472R	1970-72 Coupe RH.....	199.95 ea.
R-1472Z	1970-72 Convertible LH.....	289.95 ea.
R-1472Y	1970-72 Convertible RH.....	289.95 ea.
RWH-818AL	1981-88 Monte Carlo LH.....	305.95 ea.
RWH-818AR	1981-88 Monte Carlo RH.....	305.95 ea.

Ships Oversize 2. Not eligible for free shipping. No Volume Discount.



R-1472N

Complete El Camino Wheelhouse Assemblies

These complete wheelhouse assemblies feature the inners and outers already welded together, saving you a lot of time and money!

R-1472N	1968-72 LH.....	269.95 ea.
R-1472M	1968-72 RH.....	269.95 ea.

Ships Oversize 2. Not eligible for free shipping. No Volume Discount.

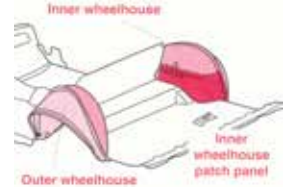

Inner Wheelhouse/Trunk Patch

This die stamped panel replaces the most commonly rusted area in the trunk. It extends from the inner wheel well joint approximately 8" to where the inner wheelhouse meets the trunk.

RG-23L	1968-72 LH.....	59.95 ea.
RG-23R	1968-72 RH.....	59.95 ea.
RG23-KIT	1968-72 Pair.....	107.91 kit

Ships Oversize. Not eligible for free shipping.



RWH-191L

Chevelle Inner Rear Wheelhouses

New inner rear section of wheelhouse which installs between the trunk area and seams to the outer wheelhouse. It is always a good idea to replace your wheelhouses when you replace your quarter panels!

RWH-191L	1964-67 LH.....	85.95 ea.
RWH-191R	1964-67 RH.....	85.95 ea.
RWH-191K	1964-67 All Pair.....	154.71 kit
RWH-291L	1968-72 Coupe LH.....	75.95 ea.
RWH-291R	1968-72 Coupe RH.....	75.95 ea.
RWH-301L	1970-72 Convertible LH.....	119.95 ea.
RWH-301R	1970-72 Convertible RH.....	119.95 ea.

Ships Oversize 2. Not eligible for free shipping. No Volume Discount.



RWH-650TL

Outer Rear Wheelhouses

Correct steel wheelhouses which attach to the inside of the quarter panel. It is always a good idea to replace your wheelhouses when you replace your quarter panels! Buy the pair and save 10%. Just ask your sales rep!

Chevelle

RWH-650TL	1964-65 LH.....	83.99 ea.
RWH-650TR	1964-65 RH.....	83.99 ea.
RWH-660TL	1966-67 LH.....	69.99 ea.
RWH-660TR	1966-67 RH.....	69.99 ea.
RWH-680TL	1968-69 LH.....	69.95 ea.
RWH-680TR	1968-69 RH.....	69.95 ea.
RWH-720TL	1970-72 Coupe LH.....	59.95 ea.
RWH-720TR	1970-72 Coupe RH.....	59.95 ea.
RWH-720TK	1970-72 Coupe Pair.....	101.92 kit
RWH-72COTL	1970-72 Convertible LH.....	109.95 ea.
RWH-72COTR	1970-72 Convertible RH.....	109.95 ea.

El Camino & G-Body

RWH-680TL	1968-72 El Camino LH.....	69.95 ea.
RWH-680TR	1968-72 El Camino RH.....	69.95 ea.
RWH-780L	1978-87 El Camino LH.....	99.95 ea.
RWH-780R	1978-87 El Camino RH.....	99.95 ea.
RWH-818MCOL	1981-88 Monte Carlo LH.....	119.95 ea.
RWH-818MCO	1981-88 Monte Carlo RH.....	119.95 ea.

1968-72 El Camino are the same as 1968-69 Chevelle.

Ships Oversize. Not eligible for free shipping. No Volume Discount.

QUARTER PANEL

Quarter Panels

If your original quarter panels are dented or rotted right through to the ground, these reproduction quarter panels are the perfect replacement! There is no need to spend a fortune on an NOS quarter because these reproductions feature a complete door jamb area, complete trunk jamb area and full roof sail panel. These are extremely high quality pieces, so you can be sure to get the best fit possible.

No Volume Discount. All quarter panels ship Truck Freight to a commercial address. Not eligible for free shipping.

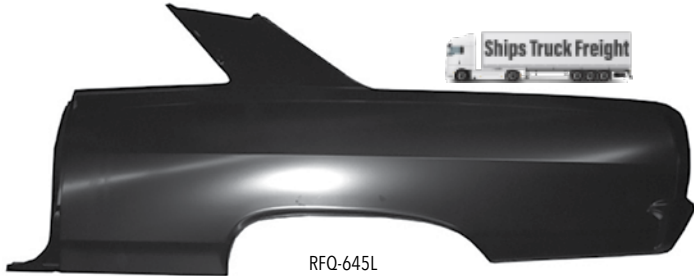

RFQ-645L

RFQ-645L	1964-65 Chevelle Coupe LH.....	349.99 ea.
RFQ-645R	1964-65 Chevelle Coupe RH.....	349.99 ea.
RFQ-645K	1964-65 Chevelle Coupe (Buy The Pair And Save).....	586.71 kit

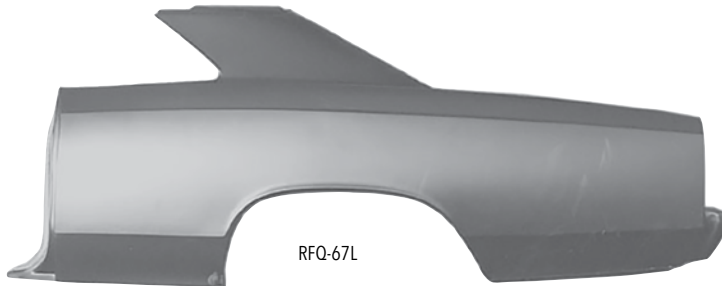

RFQ-67L

RFQ-67L	1966-67 Chevelle Coupe LH.....	339.95 ea.
RFQ-67R	1966-67 Chevelle Coupe RH.....	339.95 ea.
RFQ-67K	1966-67 Chevelle Coupe (Buy The Pair And Save).....	611.91 kit



RFQ-68L

RFQ-68L	1968 Chevelle Coupe LH.....	339.95 ea.
RFQ-68R	1968 Chevelle Coupe RH.....	339.95 ea.
RFQ-68K	1968 Chevelle Coupe (Buy The Pair And Save).....	611.91 kit



RFQ-69L

RFQ-69L	1969 Chevelle Coupe LH.....	339.95 ea.
RFQ-69R	1969 Chevelle Coupe RH.....	339.95 ea.
RFQ-69K	1969 Chevelle Coupe (Buy The Pair And Save).....	611.91 kit



RFQ-405L

RFQ-405L	1970-72 Chevelle Coupe LH.....	339.95 ea.
RFQ-405R	1970-72 Chevelle Coupe RH.....	339.95 ea.
RFQ-405K	1970-72 Chevelle Coupe (Buy The Pair And Save).....	611.91 kit
RFQ-404L	1970-72 Chevelle Convertible LH.....	410.95 ea.
RFQ-404R	1970-72 Chevelle Convertible RH.....	410.95 ea.
RFQ-404K	1970-72 Chevelle Convertible (Buy The Pair And Save).....	739.71 kit



RFQ-1475HN



RFQ-E7R

RFQ-1475HN	1964-65 El Camino LH.....	499.99 ea.
RFQ-1475HM	1964-65 El Camino RH.....	499.99 ea.
RFQ-E7L	1968-72 El Camino LH.....	439.95 ea.
RFQ-E7R	1968-72 El Camino RH.....	439.95 ea.
RFQ-E78L	1978-87 El Camino LH.....	399.95 ea.
RFQ-E78R	1978-87 El Camino RH.....	399.95 ea.
RFQ-818L	1981-88 Monte Carlo LH OE Quality.....	379.95 ea.
RFQ-818R	1981-88 Monte Carlo RH OE Quality.....	379.95 ea.



QOS-64L

Quarter Panel Skins

These quarter panel repair skins offer a quick and inexpensive way to repair your original factory quarter panels without fully cutting them out. They extend from the upper belt line down. Fits all coupes and convertibles.

QOS-64L	1964-65 Chevelle LH 85" x 29".....	199.95 ea.
QOS-64R	1964-65 Chevelle RH 85" x 29".....	199.95 ea.
QOS-66L	1966-67 Chevelle LH 88" x 30".....	179.95 ea.
QOS-66R	1966-67 Chevelle RH 88" x 30".....	179.95 ea.
QOS-68L	1968 Chevelle LH 77" x 27".....	179.95 ea.
QOS-68R	1968 Chevelle RH 77" x 27".....	179.95 ea.
QOS-69L	1969 Chevelle LH 77" x 27".....	179.95 ea.
QOS-69R	1969 Chevelle RH 77" x 27".....	179.95 ea.
QOS-70L	1970-72 Chevelle LH 77" x 27".....	199.95 ea.
QOS-70R	1970-72 Chevelle RH 77" x 27".....	199.95 ea.
QOS-74L	1973-77 Chevelle LH 77" x 27".....	199.95 ea.
QOS-74R	1973-77 Chevelle RH 77" x 27".....	199.95 ea.
QOS-E73L	1973-77 El Camino LH.....	234.95 ea.
QOS-E73R	1973-77 El Camino RH.....	234.95 ea.
QOS-E6L	1968-72 El Camino LH.....	239.95 ea.
QOS-E6R	1968-72 El Camino RH.....	239.95 ea.
QOS-E73L	1973-77 El Camino LH 78" x 30".....	234.95 ea.
QOS-E73R	1973-77 El Camino RH 78" x 30".....	234.95 ea.
QOS-78E80L	1978-87 El Camino LH.....	259.95 ea.
QOS-78E80R	1978-87 El Camino RH.....	259.95 ea.
QOS-81OLDSL	1981-88 Cutlass 442 LH.....	174.99 ea.
QOS-81OLDSR	1981-88 Cutlass 442 RH.....	174.99 ea.



RQR-645L



RQR-66L



RQR-68L



RQR-70L

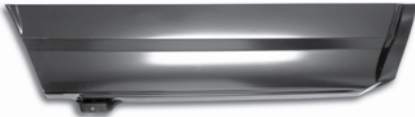

RQR-8L

Quarter Panel Patches

High quality die stamped lower quarter panel repair panels are perfect when your entire quarter panel isn't rotted out!

Chevelle		
RQR-645L	1964-65 LH.....	49.99 ea.
RQR-645R	1964-65 RH.....	49.99 ea.
RQR-66L	1966-67 LH.....	49.99 ea.
RQR-66R	1966-67 RH.....	49.99 ea.
RQR-68L	1968 LH.....	49.99 ea.
RQR-68R	1968 RH.....	49.99 ea.
RQR-69AL	1969 LH.....	49.99 ea.
RQR-69AR	1969 RH.....	49.99 ea.
RQR-70L	1970-72 LH.....	49.99 ea.
RQR-70R	1970-72 RH.....	49.99 ea.
RQR-81OLDSRL	1981-88 Cutlass 442 Rear LH.....	54.99 ea.
RQR-81OLDSRR	1981-88 Cutlass 442 Rear RH.....	54.99 ea.
RQR-8187L	1981-87 Regal GN Rear LH.....	69.95 ea.
RQR-8187R	1981-87 Regal GN Rear RH.....	69.95 ea.

El Camino		
RQR-8L	1968-72 LH.....	49.99 ea.
RQR-8R	1968-72 RH.....	49.99 ea.
RQR-78EFL	1978-87 El Camino Front LH.....	69.95 ea.
RQR-78EFR	1978-87 El Camino Front RH.....	69.95 ea.
RQR-78L	1978-87 El Camino Rear LH.....	59.95 ea.
RQR-78R	1978-87 El Camino Rear RH.....	59.95 ea.

FLOOR & RELATED



THIS IS AN
EXCLUSIVE
GROUND UP PRODUCT

Ships Truck Freight

1964-67 Full Floor Pan w/ Braces & Rear Seat Pan

This complete floor pan features all braces as well as rear seat panel already installed! This will save you hours over welding in individual pieces of floor pan!

RFP-647XP	1964-67 Chevelle.....	499.95 ea.
RFP-1462W	1964-67 Full w/o Braces.....	399.95 ea.

No Volume Discount. Ships Truck Freight to a commercial address. Not eligible for free shipping.

1968-72 Full Floor Pan w/ Braces & Rear Seat Pan

This complete floor pan features all braces as well as rear seat panel already installed! This will save you hours over welding in individual pieces of floor pan!

RFP-1462X	1968-72 Chevelle.....	599.95 ea.
-----------	-----------------------	------------

No Volume Discount. Ships Truck Freight to a commercial address. Not eligible for free shipping.



1968-72 Full Floor Pan w/ Braces, Rear Seat Pan & Rockers



This is the ultimate monster floor pan featuring all braces, rear seat panel and rocker panels completely assembled saving you a ton of time and money over individually piecing together a floor!

RFP-1462Y	1968-72 Chevelle.....	899.95 ea.
-----------	-----------------------	------------

No Volume Discount. Ships Truck Freight to a commercial address. Not eligible for free shipping.



1968-72 Full Floor Pan

This is an excellent basic replacement full floor minus the braces, rear seat pan and rocker panels.

RFP-1462	1968-72 Chevelle.....	299.95 ea.
----------	-----------------------	------------

No Volume Discount. Ships Truck Freight to a commercial address. Not eligible for free shipping.



1964-67 Full Floor Pan w/ Braces Inner Rockers & Rear Seat Pan

This complete floor pan features all the braces, the inner rockers and the rear seat pan. Also included are seatbelt provisions, rear seat hold and wiring hold downs. This will save you hours of labor over welding in individual floor pan patches!

RFP-647XP-AMD 1964-67 Chevelle589.95 ea.
No Volume Discount. Ships truck freight to a commercial address. Not eligible for free shipping.



1968-72 Full Floor Pan w/ Braces Inner Rockers & Rear Seat Pan

This complete floor pan features all the braces, the inner rockers and the rear seat pan. Also included are seatbelt provisions, rear seat hold and wiring hold downs. This will save you hours of labor over welding in individual floor pan patches!

RFP-1462X-AMD 1968-72 Chevelle589.95 ea.
No Volume Discount. Ships truck freight to a commercial address. Not eligible for free shipping.

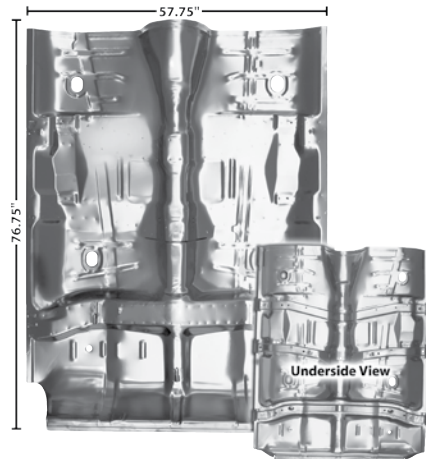

1968-69 El Camino Full Floor Pan w/ Braces

This complete full floor pan includes the front, center and rear floor pan braces and will save you a ton of time and money over welding together individual pieces and braces!

RFP-1462ZB 1968-69 El Camino799.95 ea.
No Volume Discount. Ships Truck Freight to a commercial address. Not eligible for free shipping.

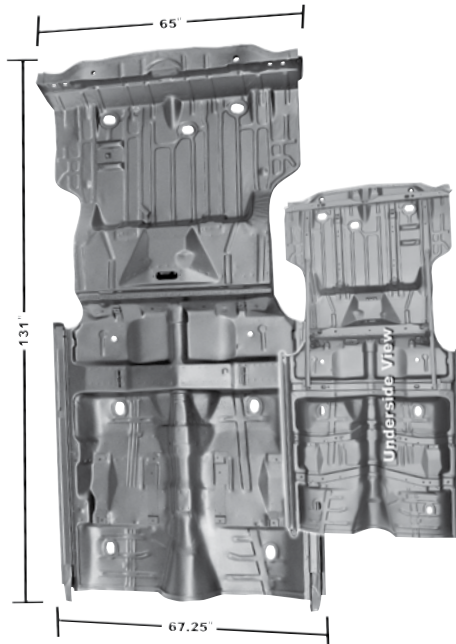

Complete Full Floor Pan with Complete Trunk Pan

This complete monster floor pan with trunk floor is the ultimate solution for rotted out floors and will replace the entire old underside of your Chevelle in one shot. This huge floor pan includes the floor pan braces, rockers, rear seat pan and trunk pan already assembled, which will save you hours of labor over welding together individual pieces!

RFP-1462YB 1968 Chevelle2799.95 ea.
No Volume Discount. Ships Truck Freight to a commercial address. Not eligible for free shipping.



1978-88 El Camino, Malibu Full Floor

The days of welding together pieces of floors are finally over. This new El Camino, Caballero and Malibu full floor pan is a direct replacement for your old, rotted floor and will save you tons of time and money because you won't have to weld-in and finish individual pieces.

RFP-7888 1978-88 All *419.99 ea.

* Direct replacement for 1978-87 El Camino. May require some cutting on the rear for Malibu, Monte Carlo, Regal, Cutlass and Grand Prix. This is the floor pan only. It does not include any braces or brackets.

Ships Truck Freight To A Commercial Address. Not eligible for free shipping.



Half Side Floor Pans

Full half side floor panels which seam in the middle. All 1964-67 floor panels feature wiring harness retainers as well as gas pedal mounting plate as original.

RP-64FL 1964-67 Chevelle LH 99.95 ea.
RP-64FR 1964-67 Chevelle RH 99.95 ea.
RP-68FL 1968-72 Chevelle LH109.99 ea.
RP-68FR 1968-72 Chevelle RH109.99 ea.
RP-64FL 1964-72 El Camino LH* 99.95 ea.
RP-64FR 1964-72 El Camino RH* 99.95 ea.
RFP-78L 1978-88 El Camino** LH149.95 ea.
RFP-78R 1978-88 El Camino** RH149.95 ea.

*Will require modification to fit El Camino.
** Can be cut to fit Malibu and Monte Carlo
Ships Truck Freight to a commercial address. Not eligible for free shipping.



1964-1967



RFP-64FL

RFP-64FR



RFP-64RL

RFP-64RR

1968-1972



RFP-72FL

RFP-72FR



RFP-72RL

RFP-72RR

Floor Pan Patches

These front floor patches are high quality and constructed of heavy gauge steel. Perfect when only portions of your floor are rotted out.

RFP-64FL	1964-67 Chevelle Front LH.....	69.99 ea.
RFP-64FR	1964-67 Chevelle Front RH.....	69.99 ea.
RFP-64FL	1964-72 El Camino Front LH.....	69.99 ea.
RFP-64FR	1964-72 El Camino Front RH.....	69.99 ea.
RFP-72FL	1968-72 Chevelle Front LH.....	69.99 ea.
RFP-72FR	1968-72 Chevelle Front RH.....	69.99 ea.
RFP-64RL	1964-67 Chevelle Rear LH.....	69.99 ea.
RFP-64RR	1964-67 Chevelle Rear RH.....	69.99 ea.
RFP-64RL	1964-72 El Camino Rear LH.....	69.99 ea.
RFP-64RR	1964-72 El Camino Rear RH.....	69.99 ea.
RFP-72RL	1968-72 Chevelle Rear LH.....	69.99 ea.
RFP-72RR	1968-72 Chevelle Rear RH.....	69.99 ea.
RFP-78FL	1978-87 El Camino Front LH*.....	75.95 ea.
RFP-78FR	1978-87 El Camino Front RH*.....	75.95 ea.
RFP-78RL	1978-87 El Camino Rear LH*.....	75.95 ea.
RFP-78RR	1978-87 El Camino Rear RH*.....	75.95 ea.

*Can be used on other G-bodies with modifications.

Ships Oversize. Not eligible for free shipping.



Floor Pan Patch Kit

This Chevelle floor pan patch kit includes front left and right floor pan patches and rear left and right floor pan patches. This is a great lower cost alternative to a full floor pan because this kit can ship via UPS instead of truck freight.

RFP-64K	1964-67 Chevelle	251.96 kit
RFP-64K	1964-72 El Camino	251.96 kit
RFP-72K	1968-72 Chevelle	251.96 kit

*Ships Oversize 2. Not eligible for free shipping.
No Volume Discount.*

BUY'N SAVE
WITH KITS



Toe Boards

This toe board or floor pan extension connects the front of the floor pan to the firewall and is a commonly rotted out area. Now includes part of the transmission hump.

RTB-64L	1964-67 LH.....	59.95 ea.
RTB-64R	1964-67 RH.....	59.95 ea.
RTB-68L	1968-72 LH.....	59.95 ea.
RTB-68R	1968-72 RH.....	59.95 ea.

GROUND UP
SS396
#1 TECH SUPPORT IN THE INDUSTRY!
CALL A TECH TODAY!!
866-358-2277

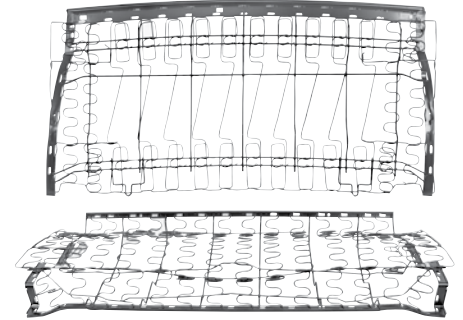

ISF-1402H



ISA-668L

Bucket Seat Frames

Complete bucket seat frame assemblies with seat springs already installed!

ISA-668L	1966-68 LH.....	389.95 ea.
ISA-668R	1966-68 RH.....	389.95 ea.
ISA-669	1969-72 All.....	395.00 ea.

*No Volume Discount. Ships Oversize 2.
Not eligible for free shipping.*

Rear Seat Frames

This is a reproduction rear seat frame which includes the back and bottom. This is a complete replacement for your worn out original springs.

ISF-1402H	1970-72.....	619.95 ea.
-----------	--------------	------------

*No Volume Discount. Ships Truck Freight.
Not eligible for free shipping.*



Convertible Top Frame Assembly

Fully assembled. The perfect replacement for your rusted out or bent original!

MCT-1417Y	1970-72 Convertible.....	1099.95 ea.
-----------	--------------------------	-------------

For power top only.

This item ships Truck Freight to a Commercial Address.



Shifter Tunnel Pans

Correct stamped steel hump which was factory installed on all 3 or 4 speed cars.

RST-76D	1964-67 All	44.95 ea.
RST-76A	1964-67 Universal	44.95 ea.
RST-66W-O	1966-67 Chrome	119.95 ea.
RST-72D	1968-72 w/ Console	79.95 ea.
RST-72A	1968-72 w/o Console	79.95 ea.
RST-73D	1973-77 All	69.95 ea.
IQ-4015	1978-88 All Plastic	29.95 ea.



Inner Rocker Panels

Reproduction die stamped inner rocker panels for an exact replacement.

RIP-647L	1964-67 LH	69.95 ea.
RIP-647R	1964-67 RH	69.95 ea.
RIP-1489T	1968-72 LH	54.95 ea.
RIP-1489S	1968-72 RH	54.95 ea.
RIP-5970	1964-72 All Drain Plugs	6.99 ea.
RIP-5970	1964-77 Inner Rocker Drain Plugs	6.99 ea.
RIP-78L	1978-88 LH Monte Carlo	79.99 ea.
RIP-78R	1978-88 RH Monte Carlo	79.99 ea.

Ships Oversize. Not eligible for free shipping.



Outer Rocker Panels

Correct gauge stamped steel full outer rocker panels with original mounting points.

RRP-647L	1964-67 LH	99.95 ea.
RRP-647R	1964-67 RH	99.95 ea.
RRP-682L	1968-72 LH	99.99 ea.
RRP-682R	1968-72 RH	99.99 ea.
RRP-E68L	1968-72 El Camino LH	145.95 ea.
RRP-E68R	1968-72 El Camino RH	145.95 ea.
RRP-78L	1978-88 LH Monte Carlo	98.99 ea.
RRP-78R	1978-88 RH Monte Carlo	98.99 ea.

Ships Oversize. Not eligible for free shipping.



Body Brace Repair

New die stamped panel that extends from wheel well area to meet trunk. This panel includes the body mount brace.

RBR-64L	1964-67 LH	84.95 ea.
RBR-64R	1964-67 RH	84.95 ea.

Ships Oversize. Not eligible for free shipping.

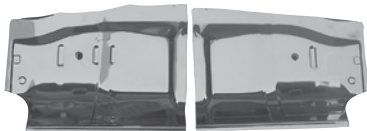

Rear Seat Floor Pan

Installs under rear seat of car.

RSP-64L	1964-67 Chevelle LH	69.95 ea.
RSP-64R	1964-67 Chevelle RH	69.95 ea.

Ships Oversize. Not eligible for free shipping.



Rear Seat Floor Pan

This new one piece under seat pan is complete with seat belt mounting plates.

RSP-647	1964-67 Chevelle	109.95 ea.
RSP-682	1968-72 Chevelle/El Camino	95.95 ea.

Ships Oversize. Not eligible for free shipping. Requires modification for El Camino.



Chevelle Rear Seat Retainer Kit

This rear seat retainer kit contains all four of the necessary retainers to hold the rear seat of your Chevelle in place.

IBX-99KR	1964-72 Chevelle	22.95 kit
BSM-REAR	1964-67 Seat Back Bolts	9.99 pr.



Bucket Seat Brackets

This is a reproduction bucket seat mounting bracket kit which will correctly mount both seats.

IBX-64K	1964-65 All	39.95 kit
IBX-89K	1966-72 All	42.99 kit
IBX-89K-FR	1966-68 All Front/Rear Set	57.99 kit
IBX-RELO	All (4pc) Relocation Brackets	32.95 kit

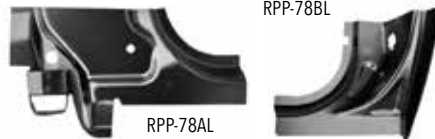

Door Jamb Repair Patches

These patches repair the commonly rusted area at the front and back of the door jamb at the bottom of the A and B pillars.

RPP-78AL	1978-88 LH A-Pillar Monte Carlo	64.99 ea.
RPP-78AR	1978-88 RH A-Pillar Monte Carlo	64.99 ea.
RPP-78BL	1978-88 LH B-Pillar Monte Carlo	69.99 ea.
RPP-78BR	1978-88 RH B-Pillar Monte Carlo	69.99 ea.

Fits 2 door only.



Rocker to Cowl Reinforcements

Heavy gauge rocker to cowl reinforcement panels. Features Weld-Thru primer.

RDH-66LL	1966-67 LH	49.99 ea.
RDH-66LR	1966-67 RH	49.99 ea.
RCR-1419	1968-72	142.95 pr.

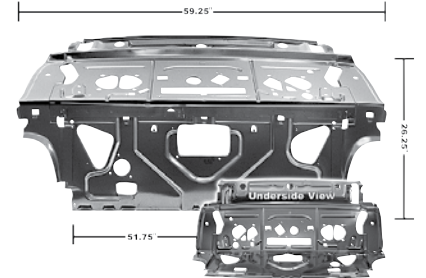

Rear Deck Repair Panel

This is a brand new rear deck repair panel which replaces the commonly rusted area under the rear deck package tray and includes the rear seat divider.

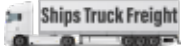

RDP-1462ZA	1968-72 Chevelle	399.95 ea.
------------	------------------	------------

Ships truck freight to a commercial address only. Not eligible for free shipping. No Volume Discount.

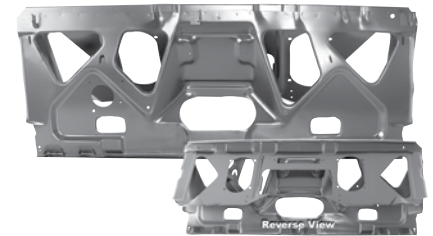

Rear Seat Mounting Panel

This piece replaces the entire rear seat mounting area which is commonly rotted out on convertibles.

RSP-1462LA	1970-72 Convertible	369.95 ea.
------------	---------------------	------------

Oversize 2. Not eligible for free shipping. No Volume Discount.



Rear Package Tray Panel

Features correct details and heavy gauge steel as original. This panel will save you time and money over trying to fabricate patch panels for this commonly rusted out area.

RDP-645A	1964-65 Coupe	169.99 ea.
RDP-1462-ZE	1966-67 Coupe	344.99 ea.
RPT-3468	1968-72 Coupe	189.99 ea.
RSE-682L	1968-72 Extension LH	64.99 ea.
RSE-682R	1968-72 Extension RH	64.99 ea.

Oversize 2. Not eligible for free shipping. No Volume Discount.



Package Tray Floor Braces

This is a pair of correct package tray braces (also referred to as X-braces).

RPT-66A	1966-67	39.99 pr.
---------	---------	-----------

CROSSMEMBERS, RAILS & BRACES



Under Seat Wire Channel

This is a correct Chevelle wire channel which is located under the seat.

RWC-64A 1964-67 Chevelle 39.95 kit

RWC-64A



RFB-84RR



RFB-85RR



RFB-86RR



RFB-87RR

Above Axle Crossmembers

Correct steel crossmembers which go under the front of the trunk directly above the rear end.

RFB-84RR 1964-67 Chevelle 89.95 ea.
 RFB-85RR 1968-69 Chevelle 94.95 ea.
 RFB-86RR 1970 Chevelle 84.95 ea.
 RFB-87RR 1971-72 Chevelle 94.95 ea.

Ships Oversize. Not eligible for free shipping.



RFR-1424E



RFR-1424J



RFR-1424K



RFR-1424L

Rear Cross Rails

These are the correct rear frame cross rails which go under the rear of the trunk.

RFR-1424E 1964-67 82.95 ea.
 RFR-1424J 1968-69 74.95 ea.
 RFR-1424K 1970 89.95 ea.
 RFR-1424L 1971-72 89.95 ea.

Ships Oversize. Not eligible for free shipping.



RFB-84F



RFB-85M



RFB-84R



RFB-85R

Floor Pan Braces

These braces are a must when replacing any parts of your floor pan! These often rusted body braces support the floor pans under the front, middle and rear seats and offer the necessary support. All braces feature correct contours and cage nuts.

RFB-84F 1964-72 Front 89.95 ea.
 RFB-85M 1964-72 Middle 89.95 ea.
 RFB-84R 1964-67 Rear 99.95 ea.
 RFB-85R 1968-72 Rear 94.95 ea.

Ships Oversize. Not eligible for free shipping.



Rear Frame Crossmember

Ties the back of the frame together.

RFR-64A 1964-67 Chevelle 109.95 ea.
 RFR-68A 1968-72 Chevelle 109.95 ea.

Ships Oversize.



RFB-64A

Body Mount Frame Repair Bracket

RFB-64A 1964-67 Chevelle 23.95 ea.



BCN-716



RCH-86L

Partial Floor Pan Braces

These partial braces extend approximately 16" from the outboard sides to the driveshaft. Cage nuts are included.

RCH-86L 1964-72 All Front LH 52.95 ea.
 RCH-86R 1964-72 All Front RH 52.95 ea.
 RCH-87L 1964-72 All Middle LH 52.95 ea.
 RCH-87R 1964-72 All Middle RH 52.95 ea.
 BCN-716 1964-72 All Cage Nut Only 8.95 ea.

TRUNK FLOOR & RELATED

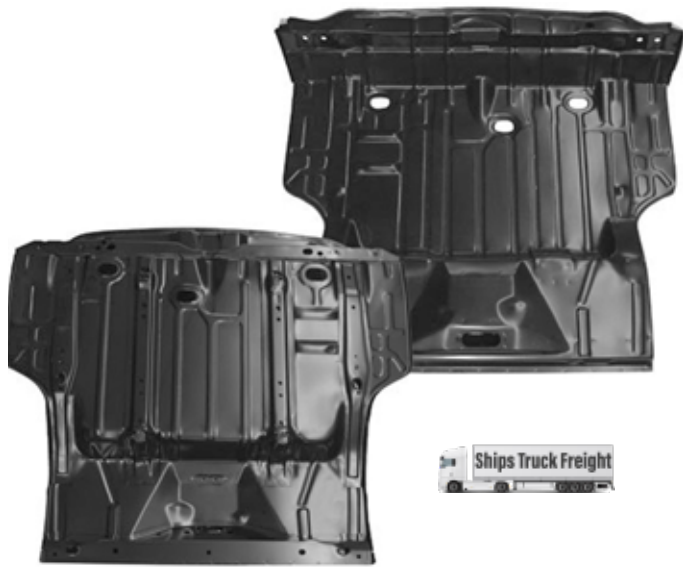

Full One Piece Trunk Floor Pans

Finally a complete one piece trunk floor is available for your Chevelle! This full floor measures approximately 61" x 56.5" and features body and fuel braces, rear reinforcement bracket, jack and spare tire brackets and correct "ribbed" floor stampings. This floor extends into the back of the rear seat as well as into the rear body panel.

RTF-164	1964-67 Chevelle*	439.95 ea.
RTF-168	1968 Chevelle	439.95 ea.
RTF-169	1969 Chevelle	439.95 ea.
RTF-170	1970 Chevelle	439.95 ea.
RTF-171	1971-72 Chevelle	439.95 ea.

*Tail panel may require slight trimming.
No Volume Discount. Ships Truck Freight to a commercial address. Not eligible for free shipping.

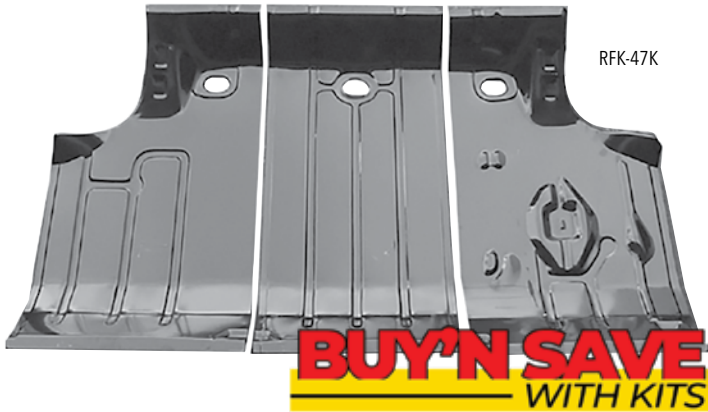

Trunk Floor Repair Patches

These individual trunk floor pieces are perfect when your entire trunk isn't rotted out and also allows you to save on shipping as opposed to a full trunk floor. Buy the set of all 3 and save!

RTF-64L	1964-67 LH	49.95 ea.
RTF-64C	1964-67 Center	49.95 ea.
RTF-64R	1964-67 RH	49.95 ea.
RTF-68L	1968-72 LH	52.95 ea.
RTF-68C	1968-72 Center	52.95 ea.
RTF-68R	1968-72 RH	52.95 ea.
RFK-47K	1964-67 (3 pc.)	127.37 kit
RFK-82K	1968-72 (3 pc.)	135.02 kit

No Volume Discount. Ships Oversize.
Not eligible for free shipping.

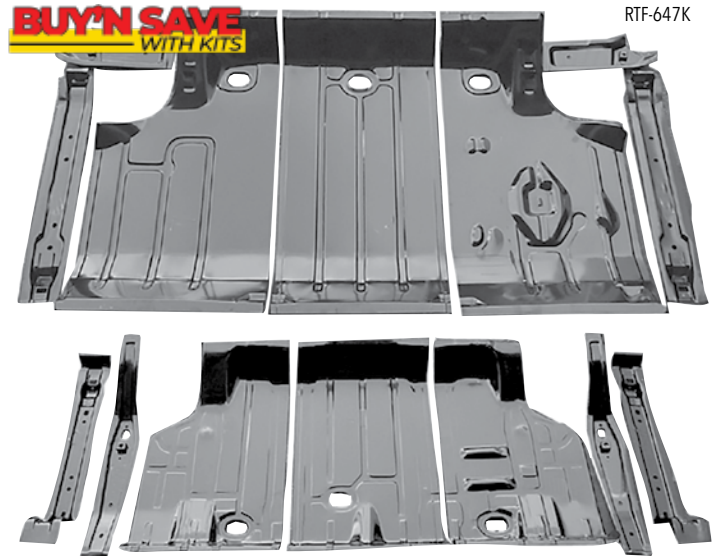

Trunk Floor Kits

This 7 piece kit includes (3) trunk floor sections, (2) frame braces and (2) fuel tank braces so you can do the job right while saving money.

RTF-647K	1964-67 Chevelle (7 pc.)	239.95 kit
RTF-682K	1968-72 Chevelle (7 pc.)	239.95 kit

No Volume Discount. Ships Oversize.
Not eligible for free shipping.



Trunk Floor Center Pan

This is a correct die stamped Chevelle center floor section which is perfect when only the center of your trunk floor is rotted out. Features all of the factory lines and contours. Measures 46W x 34L.

RTF-68U	1968-72	99.95 ea.
---------	---------	-----------

No Volume Discount. Ships Oversize.
Not eligible for free shipping.



Spare Tire Anchor Plates

Correct spare tire hold down and jack floor brackets.

P-2000	1964-72 Anchor Plate	9.95 ea.
P-2100	1964-67 Jack Bracket	9.95 ea.
P-2200	1968-72 Jack Bracket	9.95 ea.

RTB-647



RTB-682



Fuel Tank Braces

Correct braces that attach to the trunk floor and support the tank straps.

RTB-647	1964-67 Chevelle LH & RH	34.95 ea.
RTB-682	1968-72 Chevelle LH & RH	34.95 ea.
RTB-E64	1964-67 El Camino	69.95 pr.
RTB-E68	1968-72 El Camino	94.95 pr.

RBB-64R



RBB-68R

Trunk Floor Braces

Correct stamped steel braces that support the trunk floor. All braces include correct cage nuts.

RBB-64L	1964-67 LH	32.95 ea.
RBB-64R	1964-67 RH	32.95 ea.
RBB-68L	1968-72 LH	32.95 ea.
RBB-68R	1968-72 RH	32.95 ea.

RQE-702L



RQE-702R

Trunk Drop Offs/Quarter Panel Extensions

These die stamped drop offs connect the inside lower rear of the quarter panel to the outside of the trunk.

RQE-64L	1964-65 LH	39.95 ea.
RQE-64R	1964-65 RH	39.95 ea.
RQE-66L	1966-67 LH	39.95 ea.
RQE-66R	1966-67 RH	39.95 ea.
RQE-68L	1968 LH	39.95 ea.
RQE-68R	1968 RH	39.95 ea.
RQE-69L	1969 LH	39.95 ea.
RQE-69R	1969 RH	39.95 ea.
RQE-702L	1970-72 LH	35.95 ea.
RQE-702R	1970-72 RH	35.95 ea.

RDP-100



Trunk/Floor Pan Drain Plug

Correct die stamped floor drain plug.

RDP-100	1964-72 All	3.95 ea.
RDP-7488	1978-88 All	9.99 ea.

REAR PANEL

Rear Tail Lamp Panels

Reproduction rear body panels.



RTP-645-C 1964-65 Center Tail Panel 109.95 ea.



RTP-645-EL 1964-65 LH Extension* 59.95 ea.

RTP-645-ER 1964-65 RH Extension* 59.95 ea.

*Must modify for 1964 models.



RTP-66 1966 Chevelle 149.95 ea.



RTP-67 1967 Chevelle 139.95 ea.



RTP-69B 1968-69 Chevelle w/ Brackets... 189.95 ea.



RTP-702 1970-72 Chevelle 99.95 ea.

Ships Oversize. Not eligible for free shipping.



RTP-645



RTP-69A

Complete Rear Tail Lamp Panels

This is a brand new complete and correct tail lamp panel which will replace your damaged original exactly.

RTP-645	1964-65 Chevelle	249.95 ea.
RTP-68A	1968 Chevelle	169.95 ea.
RTP-69A	1969 Chevelle	169.95 ea.

Ships Oversize. Not eligible for free shipping.



RVP-70

Rear Valance Panels

Reproduction steel valance panel which extends horizontally from each quarter panel and mounts below bumper.

RVP-70	1970 Chevelle	52.95 ea.
RVP-712	1971-72 Chevelle	52.95 ea.

Ships Oversize. Not eligible for free shipping.

RTG-8A



Trunk Weatherstrip Gutter

This Chevelle trunk weatherstrip gutter set includes both of the metal channels which are required to properly mount your trunk weatherstrip.

RTG-4A	1964-65 Chevelle	59.95 pr.
RTG-6A	1966-67 Chevelle	59.95 pr.
RTG-8A	1968-72 Chevelle	54.95 pr.

Trunk Gutter Side Braces

Correct stamped steel side braces which support the trunk gutter.

RTB-64BL	1964-65 LH	34.95 ea.
RTB-64RL	1964-65 LH	34.95 ea.



RTB-1462T



RTB-68AL



RTP-645-RL

Tail Lamp Panel Braces

Correct tail lamp panel support braces.

RTB-66K	1966 (3 pc.)	139.99 kit
RTB-66AL	1966 Chevelle LH	54.99 ea.
RTB-66AR	1966 Chevelle RH	54.99 ea.
RTB-68AL	1968-69 LH	32.99 ea.
RTB-68AR	1968-69 RH	32.99 ea.
RTB-689K	1968-69 (2 pc)	59.99 kit

Tail Light Reinforcement

Correct tail panel reinforcement brackets.

RTP-645-RL	1964-65 LH	11.95 ea.
RTP-645-RR	1964-65 RH	11.95 ea.

Tail Lamp Panel Support Brace

Correct tail lamp panel support brace.

RTB-645	1964-65	24.95 ea.
RTB-1461P	1968-69	49.99 ea.
RTB-1462T	1970-72	39.95 ea.
RTB-66-T	1966 Center	49.99 ea.
RTB-671BK	(2 pc.) LH/RH	109.99 pr.



RFR-78EL



RFR-78ER

1978-88 Rear Frame Rails & Floor Pan Repair

Perfect for repairing the often rotted rear section of the chassis and trunk floor behind the rear wheels.

Partial Replacement Rear Frame Rails

RFR-78GL	1978-88 2 Door Coupe LH	119.95 ea.
RFR-78GR	1978-88 2 Door Coupe RH	119.95 ea.
RFR-78EL	1978-88 El Camino LH	139.99 ea.
RFR-78ER	1978-88 El Camino RH	139.95 ea.

Trunk Floor To Frame Repair Plates

RFB-78G	1978-88 2 Door Coupe	69.95 set
BCN-788	1978-88 Body Cage Nut Only Fits All	6.99 ea.

Ships Oversize. Not eligible for free shipping.

TRUNK & RELATED



Trunk Lids

Reproduction of the often rotted or damaged trunk lid.



RTL-67	1966-67 Chevelle	219.95 ea.
RTL-6872	1968-72 Chevelle 1970-72 Monte Carlo.....	195.95 ea.
RTL-8187	1981-87 Regal	419.99 ea.

No Volume Discount. Ships Truck Freight to a commercial address. Not eligible for free shipping.



Rear Window to Trunk Panel

RWP-645

Reproduction stamped steel panel which fits between the rear window and the trunk lid.

RWP-645	1964-65 Coupe.....	69.95 ea.
RWP-645-OE	1964-65 Coupe Complete OE Style	89.99 ea.
RWP-667	1966-67 Coupe.....	59.95 ea.
RWP-682	1968-72 Coupe.....	55.95 ea.
RWP-68V	1968-72 Convertible.....	79.95 ea.

Ships Oversize 2. Not eligible for free shipping.

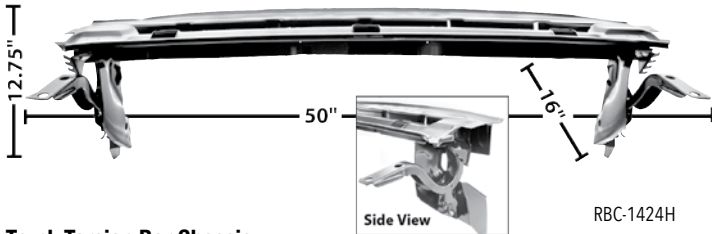

Trunk Torsion Bar Chassis

Brand new convertible trunk torsion bar chassis which is an exact replacement for your worn out original assembly.

RBC-1424H	1970-72 Convertible.....	269.95 ea.
-----------	--------------------------	------------

Ships Oversize. Not eligible for free shipping. Does not include torsion bars.



Trunk Torsion Rods

RLS-097

Correct torsion rods for holding up trunk lid.

RLS-097	1964-65 All	54.95 pr.
RLS-098	1966-67 All	54.95 pr.
RLS-099	1968-72 Convertible.....	54.95 pr.
RLS-100	1968-72 Coupe.....	54.95 pr.



Eddie Motorsports Billet Trunk Hinges

These billet trunk hinges are CNC machined from high quality 6061-T6 aluminum. They utilize Nitrogen filled gas struts that replace the stock torsion springs and high quality Delrin bushings for smooth reliable operation. The hinges are designed as direct fit, "bolt on" parts with some minor drilling required for fastening of the strut mount. The hinges come complete with mounting hardware, brackets (where required) and gas struts.

M = Machined	W = White Fusioncoat	MB = Matte Black Fusioncoat
P = Polished	PR = Purple Fusioncoat	MBA = Matte Black Anodized
R = Red Fusioncoat	BK = Gloss Black Fusioncoat	CL = Clear Coat
B = Blue Fusioncoat	BKA = Gloss Black Anodized	CA = Clear Anodized

		M	P	R, B, W, PR, BK, BKA, MB, MBA, CL, CA
MS149-09	1966-67 All	370.99 pr.....	405.99 pr.....	435.99 pr.
MS149-10	1968-72 All	370.99 pr.....	405.99 pr.....	435.99 pr.

1968-72 Trunk Hinges

Reproduction trunk hinges to replace your worn out originals.

RTH-1489DA	1968-72 Coupe.....	149.95 pr.
RTH-1489DD	1970-72 Convertible.....	195.95 pr.

RTH-1489DA

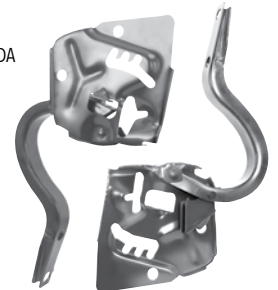

Trunk Wire Clip

Correct clips used to hold the power trunk or trunk light wires to the hinge.

GWC-SPK	1964-77 All	13.99 pr.
---------	-------------------	-----------



Trunk Latch

Correct trunk latch inside of the trunk lid.

RTL-1019	1968-72	29.95 ea.
TLB-716	1964-77 Latch Bolts (5pc).....	8.99 set



RTL-1019

Trunk Catch (Striker)

Mounts inside the trunk to catch the trunk latch.

RTL-6470	1964-69	23.99 ea.
RTB-66-T	1966-67 Brace	49.99 ea.
RLC-1462U	1970-72	18.95 ea.



RTL-6470

BED FLOOR

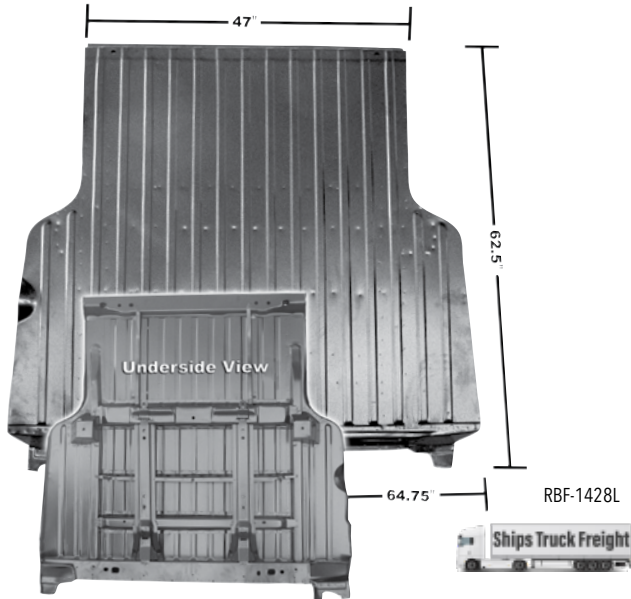

El Camino Bed Floor Panel

This is a complete bed floor with braces and roll pan.

- RBF-1428L 1968-72 Bed With Supports & Roll Pan.....1099.95 ea.
- RBF-78 1978-87 Full Bed Floor w/o Braces.....359.95 ea.

No Volume Discount. All floors ship Truck Freight to a commercial address. Not eligible for free shipping.



RBF-1428H

El Camino Bed Floor w/ Braces

Complete bed panel with under panel support braces.

- RBF-1428H 1968-72.....749.95 ea.

No Volume Discount. All floors ship Truck Freight to a commercial address. Not eligible for free shipping.



RIQ-1475HC

El Camino Complete Inner Quarters

Complete inner quarter panels with wheelhouse already attached!

- RIQ-1475HC 1968-72 El Camino LH.....799.95 ea.
- RIQ-1475GC 1968-72 El Camino RH.....799.95 ea.

No Volume Discount. Ships Truck Freight to a commercial address. Not eligible for free shipping.



TAILGATE & RELATED



RTG-1428

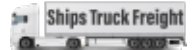

Complete Tailgates

Reproduction ready to install complete tailgates.

- RTG-1429D 1964-67.....419.95 ea.
- RTG-1428 1968-72 w/o Backup Light Holes.....269.95 ea.
- RTG-1429 1968-72 w/ Backup Light Holes.....269.95 ea.
- RTG-78 1978-87.....449.99 ea.

No Volume Discount. Ships Truck Freight to a commercial address. Not eligible for free shipping.



RTG-64



RTG-92



El Camino Tailgate Skins

Reproduction tailgate skins, perfect when your inner structure has not rotted out.

- RTG-64 1964-66 w/ Emblem Holes.....159.95 ea.
- RTG-67 1967 w/o Emblem Holes.....159.95 ea.
- RTG-68 1968 w/o Reverse Light Holes.....159.95 ea.
- RTG-92 1969-72 w/ Reverse Light Holes.....159.95 ea.

No Volume Discount. Ships Truck Freight to a commercial address. Not eligible for free shipping.



RGL-1429A

El Camino Tailgate Latch Set

Complete set of new latches for tailgate.

- RGL-1429A 1968-72 El Camino.....99.95 set

EL CAMINO BED ACCESSORIES



El Camino Spare Tire Panel

Reproduction panel which mounts behind the seat in the spare tire area.

RTP-1428A 1968-72 El Camino 144.95 ea.
Ships Oversize. Not eligible for free shipping. No Volume Discount.



El Camino Below Rear Window Panel

RFB-1428B

This corrugated steel panel fits below the rear window.

RFB-1428B 1968-72 El Camino 249.95 ea.
 RFB-78 1978-87 El Camino 169.95 ea.
Ships Oversize. Not eligible for free shipping. No Volume Discount.

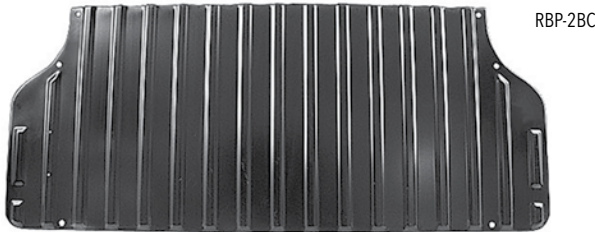

El Camino Front Bed Lift Panel

Reproduction of the front bed lift out panel.

RBP-28C 1968-72 El Camino 119.95 ea.
*Ships Truck Freight to a Commercial Address only.
 Not eligible for free shipping.*



El Camino Inner Panels

Reproduction stamped inner bed panels.

RIB-1475HA 1968-72 El Camino LH 274.95 ea.
 RIB-1475GA 1968-72 El Camino RH 274.95 ea.
 RIB-78L 1978-87 El Camino LH 189.95 ea.
 RIB-78R 1978-87 El Camino RH 189.95 ea.
Ships Oversize. Not eligible for free shipping. No Volume Discount.



RQF-1462R



RQF-1462Q

El Camino Bed to Quarter Fillers

Correct filler panels which install between the bed and quarter panels.

RIB-1475HQ 1964-67 LH 109.95 ea.
 RIB-1475HP 1964-67 RH 109.95 ea.
 RQF-1462R 1968-72 LH 169.95 ea.
 RQF-1462Q 1968-72 RH 129.95 ea.

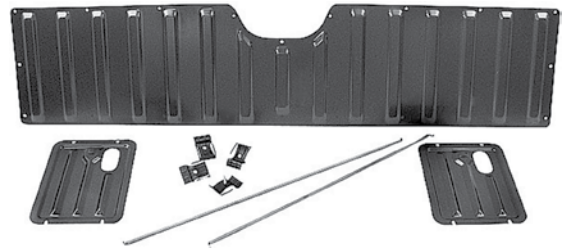

El Camino Tailgate Inner Panel Kit

RGP-E5

Bolt-in panels for the inside of your tailgate.

RGP-E3 1964-67 El Camino 3 pc 169.95 kit
 RGP-E5 1968-72 El Camino 9 pc 109.95 ea.
No Volume Discount. Ships Oversize. Not eligible for free shipping.



RWP-E4

El Camino Rear Window Panel

Correct steel repair panel between rear window and bed.

RWP-E4 1964-67 El Camino 42.99 ea.
 RWP-E8 1968-72 El Camino 39.95 ea.
Ships Oversize. Not eligible for free shipping.



RSP-1428D

El Camino Rear Window Shelf Panel

Correct weld-in panel which installs behind the rear seat and below the rear window inside of the cab.

RSP-1428D 1968-72 El Camino 119.95 ea.
Ships Oversize. Not eligible for free shipping.



El Camino Bed Lift Panel Support

RBP-1428G

Reproduction bed lift panel support.

RBP-1428G 1964-67 El Camino 119.95 ea.
Ships Oversize. Not eligible for free shipping.



El Camino Divider Panel Kit

RDP-1428F

Reproduction divider panel with cutouts.

RDP-1428F 1964-67 El Camino 179.95 kit
Ships Oversize. Not eligible for free shipping.



Rear of Bed Roll Pan

RBF-1428K

Reproduction roll pan for the rear of the bed.

RBF-1428K 1968-72 329.95 ea.
No Volume Discount. Ships Truck Freight to a commercial address. Not eligible for free shipping.



Rear Bed Cross Rail

RBF-1428J

Reproduction rear cross bar for the rear of the bed.

RBF-1428J 1968-72 89.95 ea.
No Volume Discount. Ships Oversize 2. Not eligible for free shipping.



RMP-1423B

El Camino Tail Lamp Mounting Panels

Brand new tail lamp mounting panels to replace your rusty originals.

RMP-1475HS	1964-65 LH.....	96.95 ea.
RMP-1475HR	1964-65 RH.....	96.95 ea.
RMP-1423B	1968-72 LH.....	92.95 ea.
RMP-1423A	1968-72 RH.....	92.95 ea.

Ships Oversize. Not eligible for free shipping.



RIB-1475HB

El Camino Front Inner Quarter Panels

Reproduction stamped front inner quarter panels.

RIB-1475HB	1968-72 El Camino LH.....	69.95 ea.
RIB-1475GB	1968-72 El Camino RH.....	69.95 ea.



RFD-1475L

El Camino Fuel Tank Door

Reproduction of the often damaged or missing fuel tank door.

RFD-1475HT	1964-67.....	89.99 ea.
RFD-1475L	1968-72.....	54.95 ea.

RTG-647RB



Tailgate Hinge Rebuild Kit

Correct pins and bushings to make both tailgate hinges work like new. Original head markings and brass bushings to match originals.

RTG-647RB	1964-67.....	23.99 kit
RTG-682RB	1968-72.....	23.99 kit

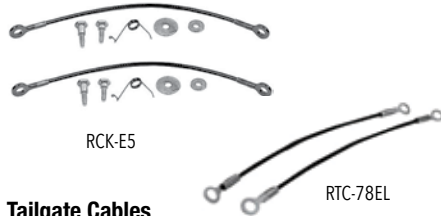

RCK-E5

RTC-78EL

Tailgate Cables

Reproduction tailgate cables featuring top quality sheathed cables. 1968-77 kits come with cables, springs, and bolts.

RCK-E5	1968-77 w/ Hardware.....	36.99 set
RTC-78EL	1978-88 Cables Only.....	39.95 pr.



JSB-E33

Tailgate Bumpers

Correct rubber stop bumpers which prevent the tailgate from hitting metal on metal.

JSB-E33	1968-72 El Camino.....	2.95 ea.
---------	------------------------	----------



RTH-E4817

Tailgate Handle

Reproduction inner tailgate handle with nylon washer.

RTH-E4817	1968-72.....	14.99 ea.
-----------	--------------	-----------



RGK-200

Tailgate/Bed Fastener Kit

Correct set of fasteners for tailgate and rear of bed.

RGK-200	1964-72 El Camino.....	10.95 kit
---------	------------------------	-----------



RSK-E7

Bed & Tailgate Bolt Kit

Complete kit with all correct bolts and screws for hinges, tailgate and bed floor.

RSK-E7	1968-72 El Camino.....	46.95 kit
--------	------------------------	-----------

RTH-1490H



Tailgate Hinges

Reproduction tailgate hinges to replace your worn out originals.

RTH-1490H	1968-72.....	169.95 pr.
-----------	--------------	------------

RTS-1490E



Tailgate Cable Springs

Correct pair of tailgate cable springs.

RTS-1490E	1964-72.....	4.95 pr.
RTS-1490F	1973-87.....	4.95 pr.

GROUND UP
55396

Sheet Metal

Bringing you the highest quality sheet metal for your restoration!