

Fan Shrouds

These are brand new, injection molded reproduction fan shrouds with the same "raw" finish as original GM. These shrouds are constructed using ABS "plastic injection" just as original GM. (1964-65 is metal like original.)

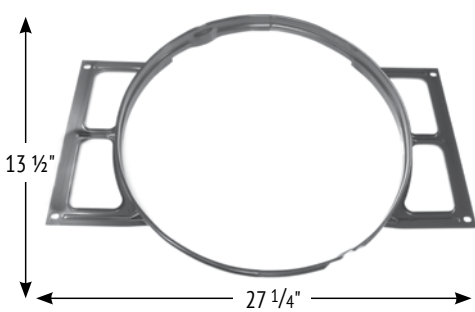

AFS-1487W 1964-65 All V8 Metal..... 84.95 ea.

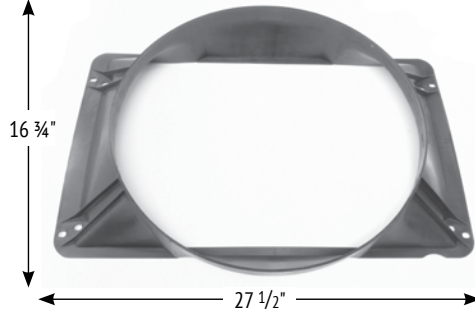

AFS-67S 1966-67 All SB 27" W x 17" H.... 89.95 ea.

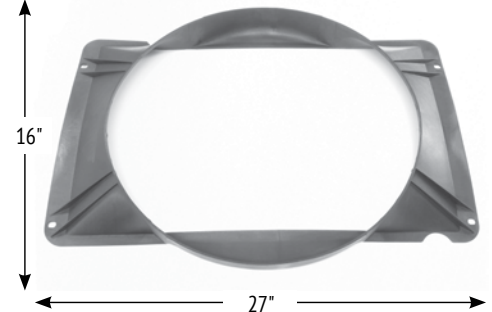

AFS-67B 1966-67 All BB 27" W x 16" H..... 89.95 ea.

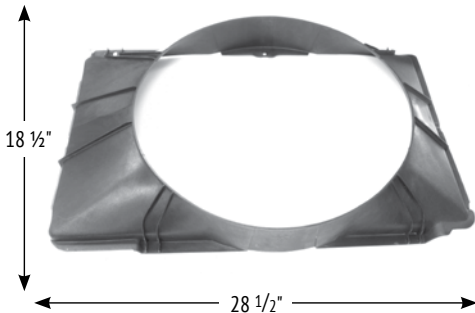

AFS-68S 1968 All SB 119.99 ea.

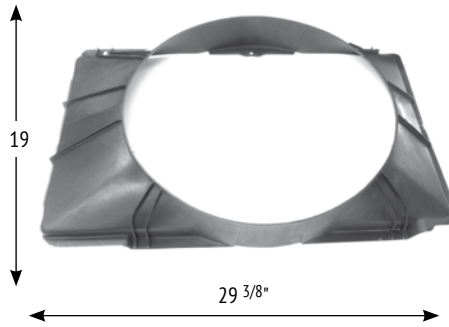

AFS-68B 1968 All BB 29 3/8" W x 19" H.. 95.99 ea.



AFS-697031 1969-70 Small Block 23.5 WX 19.25 H..... 109.99 ea.

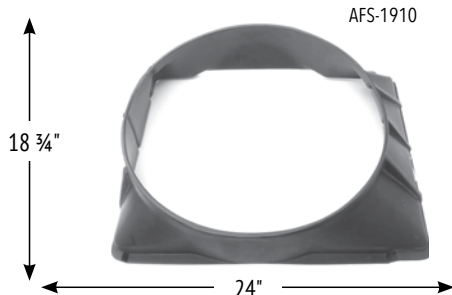

AFS-1910

AFS-1910 1969-70 SB Small 24" Wide..... 89.95 ea.
AFS-1912 1971-75 SB 29.5" Wide..... 169.99 ea.

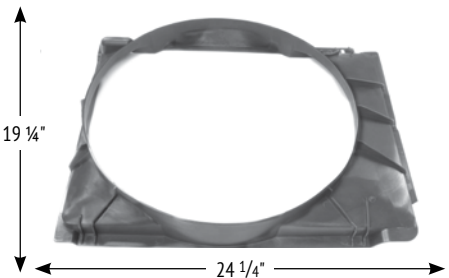

ABC-1914 1969-70 All BB* 24.5" W x 19 1/4" H 69.95 ea.

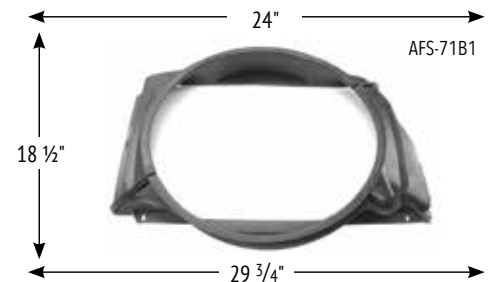

AFS-71B1

AFS-71B1 1971-75 BB 26" Core..... 119.95 ea.
AFS-71B2 1971-75 BB 28" Core 29.5" W x 19" H..... 119.95 ea.



AFS-1912

**This fan shroud duplicates the original GM fan shroud part number 6261914 used on all 1969-70 SS396 or SS454 models. This shroud was used on both standard 26" core radiators as well as heavy duty 28" core radiators. This shroud did not fully cover the entire 28" radiator but this is correct. Use our AFS-71B2 if you wish to cover your entire 28" radiator.*

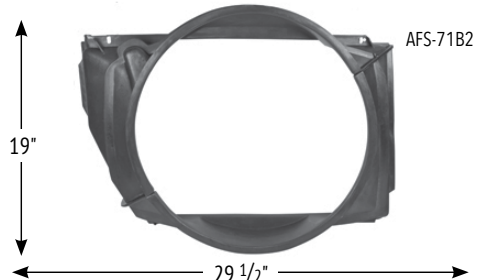

AFS-71B2

*1971-72 uses a 2 piece design. 26" core is standard, 28" core is HD.



FANKIT-7BL



Fan Clutch Kits

Complete kit to convert your car to this heavy duty GM fan clutch option. This kit includes fan, fan clutch and all necessary hardware.

FANKIT-6BS	1964-68 6 Blade (Short WP)....	111.88 kit
FANKIT-5BR	1964-68 5 Blade (Short WP)....	127.88 kit
FANKIT-7BS	1964-68 7 Blade (Short WP)....	135.87 kit
FANKIT-7BL	1969-72 All (Long WP).....	133.32 kit



ABR-3996



APR-705

Fan Blades

Reproduction fan blades to be used with fan clutches only.

APR-705	1964-68 5 Blade 17.5"	99.95 ea.
ABR-3996	1969-72 7 Blade 18"	79.95 ea.
ABR-6BLD	1967-68 6 Blade 17.5"	79.95 ea.
ABR-7BLD	1962-68 7 Blade 17.5" Curved Tips....	99.95 ea.
ABR-5NOV	1964-72 5 Blade w/o Clutch	249.95 ea.



AWT-7719



ABR-2710



BKP-516

Fan Clutches

Heavy duty fan clutch with gold cadmium coloring.

AWT-7719	1964-68 Short Pump	52.95 ea.
ABR-2710	1969-72 Long Pump	69.95 ea.
BKP-516	Correct Attaching Nuts (4)	1.50 kit



AX-3970

Fan Shroud Attaching Kits

Correct OEM clips and screws for attaching the fan shroud.

AX-667	1966-67 All	6.95 kit
AX-3970	1968-72 All	6.95 kit



APC-0100



BPX-2792

Fan and Shroud Attaching Kits

Correct style bolts/studs for attaching fan to water pump.

BPX-2792	Attaching Stud Kit 12 Piece	6.95 kit
BPX-2791	Attaching Bolt Kit 8 Piece	5.95 kit
APC-0100	1968-72 All	2.95 pr.



INL-15090

Fan Spacers

Correct cooling fan spacers for cars that did not come equipped with a fan clutch.

INL-15090	2" 1969-77 All	21.99 ea.
INL-15091	1.5" 1969-77 All	23.99 ea.
INL-15092	1" 1969-77 All	23.99 ea.



AEF-14

Electric Cooling Fans

This electric radiator cooling fan is perfect for older muscle cars where an electric water pump is being used or as supplemental cooling.

AEF-12	12" Universal	54.99 ea.
AEF-14	14" Universal	54.99 ea.
AEF-16	16" Universal	56.99 ea.



PAC-2800BT



Dakota Digital Electronic Fan Controller

This controller was designed for the ultimate in flexibility and to be a simple add-on in any application using an electric fan. Included is a 70amp relay, enough for even the most power hungry of cooling fans. Fully programmable, the PAC-2800BT will work with your existing water temp gauge, operating from the temperature sending unit already installed.

PAC-2800BT	All w/ Electric Cooling Fans	128.99 ea.
------------	------------------------------------	------------

No Volume Discount.

KEEP A LOOK OUT FOR THESE LOGOS BELOW THROUGHOUT THE CATALOG FOR BIG SAVINGS AND DISCOUNTS ON KITS!

BUY'N SAVE WITH KITS



Price Match Guarantee



Everyday Savings



Hassle Free Returns



Knowledgeable Experts

RADIATORS & ACCESSORIES



CCS-EC289



CCS-CCFK10



CCS-CCFKRL

Aluminum Radiators by Champion Cooling Systems

These aluminum radiators are made to the highest of standards paired with unequaled quality, precision and workmanship. The highest of aluminum grades available are used in all manufacturing processes. All Champion aluminum radiators are constructed using 100% welded seams brazed core technology and absolutely no epoxy. All Champion radiators come with a lifetime limited warranty and are made to install with little or no modifications using your original mounts giving you the confidence you deserve. Choose from the following series:

- EC Economy Core Series - 2Row - Two Rows of 3/4 inch Tubes = Approx. 400-600+ Horsepower Cooling Capacity.
- CC Champion Core Series - 3Row - Three Rows of 5/8 inch Tubes = Approx. 600-800+ Horsepower Cooling Capacity.
- MC Monster Core Series - 4Row - Four Rows of 5/8 inch Tubes = Approx. 800-1200+ Horsepower Cooling Capacity.

Requires 2 - 12" fans + 1 relay

CCS-EC281	1964-65 Economy Core Series 21-3/4 x 28 OD	196.95 ea.
CCS-CC281	1964-65 Champion Core Series 21-3/4 x 28 OD	259.95 ea.
CCS-MC281	1964-65 Monster Core Series 21-3/4 x 28 OD	344.95 ea.

Requires 2 - 12" fans + 1 relay

CCS-EC289	1964-67 Economy Core Series 22-1/4 x 27-3/4 OD.....	196.95 ea.
CCS-CC289	1964-67 Champion Core Series 22-1/4 x 27-3/4 OD	259.95 ea.
CCS-MC289	1964-67 Monster Core Series 22-1/4 x 27-3/4 OD	344.95 ea.

Requires 2 - 14" fans + 2 relays

CCS-EC161	1968-77 Economy Core Series 33 x 18-5/8 OD	196.95 ea.
CCS-CC161	1968-77 Champion Core Series 33 x 18-5/8 OD	259.95 ea.
CCS-MC161	1968-77 Monster Core Series 33 x 18-5/8 OD	344.95 ea.

Requires 2 - 10" fans + 1 relay

CCS-EC571	1968-77 Economy Core Series 27 x 19 OD.....	196.95 ea.
CCS-MC571	1968-77 Monster Core Series 27 x 19 OD	344.95 ea.

Requires 2 - 10" fans + 1 relay

CCS-EC162	1978-88 Economy Core Series 18-1/4 x 31 5/8 OD.....	196.95 ea.
CCS-CC162	1978-88 Champion Core Series 18-1/4 x 31 5/8 OD.....	259.95 ea.
CCS-MC162	1978-88 Monster Core Series 18-1/4 x 31 5/8 OD	344.95 ea.

Requires 2 - 12" fans + 1 relay

CCS-EC571	1978-88 Economy Core Series 19 x 27 OD.....	196.95 ea.
CCS-MC571	1978-88 Monster Core Series 19 x 27 OD	344.95 ea.
CCS-CC571DP	1978-88 Champion Core Series 18-1/2 x 27 OD LS Swap*	369.95 ea.

*Dual pass core for LS swaps. All radiators include petcock and 16 or 19 lb cap depending on application.

Electric Cooling Fans

Features a reversible swept blade design meaning it can be configured as a puller or pusher. The blades are computer balanced.

CCS-CCFK10	10", 7.5 Amp Draw, 650 CFM	39.95 ea.
CCS-CCFK12	12", 10 Amp Draw, 870 CFM	39.95 ea.
CCS-CCFK14	14", 12 Amp Draw, 1200 CFM.....	59.99 ea.
CCS-CCFK16	16", 14 Amp Draw, 1600 CFM.....	59.95 ea.

Electric Fan Relay

Recommended for all electric fan applications. Only one relay is needed for single or dual fans.

CCS-CCFKRL	Fan Relay.....	59.99 ea.
------------	----------------	-----------

Note: 10 and 12 inch fans require one relay. 14 and 16 inch fans require two relays.

US Radiators

These direct factory replacement Desert Cooler radiators from US Radiator come complete with new high density cores, correct screw-in fittings for automatics, correct mounting brackets where applicable and are ready to install.

AKY-824A	1964-65 4 Row HD Automatic.....	529.99 ea.
AKY-824M	1964-65 4 Row HD Manual.....	499.99 ea.
AKY-834A	1966-67 4 Row HD Automatic.....	569.99 ea.
AKY-834M	1966-67 4 Row HD Manual.....	499.99 ea.
AKY-844A	1968-72 4 Row HD Automatic.....	599.99 ea.
AKY-844M	1968-72 4 Row HD Manual.....	599.99 ea.
AKY-843M	1968-72 3 Row HD Manual.....	479.99 ea.

Radiators are shipped Oversized. Not eligible for free shipping. No Volume Discount.



AKY-824A



AKY-844M



AKY-667A

1966-72 Aluminum Radiator

This new high quality aluminum radiator is a great light weight alternative to a traditional brass and copper radiator. This 2 core aluminum radiator provides excellent cooling for all engines from mild to high performance. It is made for automatic transmissions and also includes plugs so it can be used with manual transmissions.

AKY-667A	1966-67 All	341.56 ea.
AKY-6872A	1968-72 All	239.99 ea.
VHT-SP139	Radiator Paint.....	7.99 ea.

Radiators are shipped Oversized. Not eligible for free shipping.

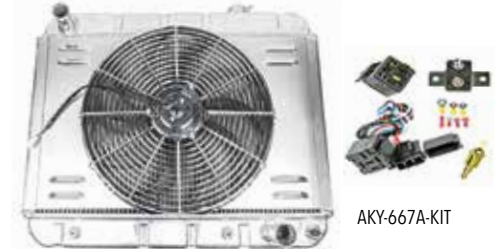

AKY-667A-KIT

1966-72 Aluminum Radiator Kits

If you are planning to upgrade your Chevelle's cooling performance, look no further than this Ground Up exclusive kit! All the essentials are included, such as a 2 core aluminum radiator, chrome fan, fan shroud and thermal kit. Aluminum radiators are a great lightweight alternative to traditional brass and copper radiators, with increased cooling efficiency via dual high flow aluminum tubes, suitable for mild to high performance applications. This radiator can be used for either automatic or manual transmissions with the included stoppers. Inlet is 1-1/2 inch, while outlet is 1-3/4 inch.

AKY-667A-KIT	1966-67 All.....	341.56 kit
AKY-6872A-KIT	1968-72 All.....	341.56 kit
VHT-SP139	Radiator Paint.....	7.99 ea.

No Volume Discount.



866-358-2277



SS396.COM

Chevelle & El Camino Catalog

Heating & Cooling

123



COLD-542M



COLD-541MFK



Cold Case Radiators

These COLD-CASE radiators are TIG welded 100% aluminum. These radiators have dual oversize 1" cooling rows making them more efficient than four 1/2" rows seen on 4 row models. Cold Case aluminum radiators cool 20% better than OEM copper radiators and are more than 50% lighter. They are original in appearance with OEM style stamped tanks for strength and that OEM original look. Once painted, they look like originals to all but the concourse fanatic. Each radiator is pressure tested, direct fit and carries a Lifetime Warranty!

COLD-541M	1964-65 Manual.....	359.99 ea.
COLD-541A	1964-65 Automatic.....	369.99 ea.
COLD-542M	1966-67 Manual.....	359.99 ea.
COLD-542A	1966-67 Automatic.....	369.99 ea.
COLD-42M	1968-72 Manual.....	359.99 ea.
COLD-42M	1968-72 Manual.....	359.99 ea.
COLD-44A	1968-72 Automatic.....	369.99 ea.
COLD-546A	1968-72 All Manual LS Swap.....	369.99 ea.
COLD-544A	1978-88 All G-Body.....	369.99 ea.
VHT-SP139	Radiator Paint.....	7.99 ea.

Kits With Electric Fan And Shroud

Cold Case made it easy with kits that include the radiator, fan and shroud. All kits come with the transmission cooler fittings in the radiator.

COLD-541MFK	1964-65 All Dual 12" Fans.....	576.99 kit
COLD-541AFK	1964-65 All Dual 12" Fans.....	584.99 kit
COLD-542MFK	1966-67 All Dual 12" Fans.....	574.99 kit
COLD-542AFK	1966-67 All Dual 12" Fans.....	583.99 kit
COLD-42MFK	1968-72 All Dual 12" Fans.....	576.99 kit
COLD-42AFK	1968-72 All Dual 12" Fans.....	549.99 kit
COLD-RC100	Radiator Cap All.....	24.99 ea.
COLD-FAN12	12 Inch Cooling Fan 1400 CFM.....	59.99 ea.
COLD-FAN16	16 Inch Cooling Fan 2500 CFM.....	75.99 ea.
COLD-EF1	Fan Wiring Kit All.....	89.99 kit

All radiators are shipped Oversize. Not eligible for free shipping. No Volume Discount.

Frostbite Performance Cooling

High-Horsepower street cars and race cars can be a challenge to keep cool. A proper cooling system starts with Frostbite. When it comes to keeping your ride cool, Make it Frostbite!



Aluminum Radiators

Our line of Performance Aluminum Radiators are available in 2, 3, and 4-row sizes as well as specific LS-Swap applications.

- 100% TIG welded (brazed) seams
- Aircraft quality aluminum core, fittings, and tanks (up to 30% weight savings)
- Billet Aluminum Filler Neck and OEM Style Brass Petcock
- Custom Frostbite High Performance 16lb. radiator cap
- Polished top and tanks for custom show appearance
- 2-Row Radiators supporting applications with 300-500 horsepower
- Transmission cooler provisions

Direct Fit

FROST-FB123	64-67 V8 All 2 Row 21.25" Wide.....	264.99 ea.
FROST-FB124	64-67 V8 All 3 Row 21.25" Wide.....	331.99 ea.
FROST-FB125	64-67 V8 All 4 Row 21.25" Wide.....	440.99 ea.
FROST-FB132	68-77 V8 All 2 Row 28.25" Wide.....	264.99 ea.
FROST-FB133	68-77 V8 All 3 Row 28.25" Wide.....	331.99 ea.
FROST-FB134	68-77 V8 All 4 Row 28.25" Wide.....	440.99 ea.
FROST-FB162	78-88 V8 All 2 Row 26" Wide.....	264.99 ea.
FROST-FB163	78-88 V8 All 3 Row 26" Wide.....	331.99 ea.
FROST-FB164	78-88 V8 All 4 Row 26" Wide.....	440.99 ea.

LS Swap

Hose fittings sold separately.		
FROST-FB304	68-72 LS All 2 Row 17" Tall.....	527.99 ea.
FROST-FB302	78-88 LS All 2 Row 17" Tall.....	527.99 ea.

Electric Fan & Shroud Kits

Fans and Shroud Kits E= Economy H= High Performance

FROST-FB508E	Dual 12" Fits FB123, 124, 125 Radiators.....	328.99 kit
FROST-FB501E	Dual 14" Fits FB132, 133, 134, 304 Radiators.....	349.99 kit
FROST-FB501H	Dual 14" Fits FB132, 133, 134, 304 Radiators.....	425.99 kit
FROST-FB502E	Dual 12" Fits FB162, 163, 164, 302 Radiators.....	328.99 kit
FROST-FB502H	Dual 12" Fits FB162, 163, 164, 302 Radiators.....	414.99 kit

Shroud Only Dual Opening

FROST-FB508	Fits FB123, 124, 125 Radiators*.....	180.99 ea.
FROST-FB501	Fits FB132, 133, 134, 304 Radiators**.....	180.99 ea.
FROST-FB502	Fits FB162, 163, 164, 302 Radiators*.....	180.99 ea.

*Dual 12" fan openings.**Dual 14" fan openings.
Note: Width and height measurements are for the core not overall.
No Volume Discount.

Fan Relay & Wiring Kit

This relay kit will allow you to custom configure your fans as pusher or puller resulting in increased cooling performance and a reduction in noise/vibration in your engine bay. Does 1 or 2 fans.

FROST-FB403	All With Electric Fans.....	97.99 kit
-------------	-----------------------------	-----------

No Volume Discount.

Hose Fittings

FROST-FB400	LS Swap 1.25".....	46.99 ea.
FROST-FB401	LS Swap 1.5".....	46.99 ea.
FROST-FB402	LS Swap 1.75".....	46.99 ea.

No Volume Discount.



FROST-FB123



FROST-FB508E



FROST-FB508



FROST-FB400



FROST-FB401



FROST-FB402

RADIATOR & ACCESSORIES *continued*



Cowl Vent Grille Covers

Dress up the cowl area of your Chevelle with this trick new cover from Undercover Innovations! Made out of 14 gauge aluminum, it's one piece design covers all three cowl vent holes making them look much more symmetrical. Stainless steel fasteners included.

AVG-68AC	1968-69 Clear Anodized	83.99 ea.
AVG-68AB	1968-69 Black Anodized	83.99 ea.
AVG-68AP	1968-69 Polished	93.99 ea.
AVG-70AC	1970-72 Clear Anodized	83.99 ea.
AVG-70AB	1970-72 Black Anodized	83.99 ea.
AVG-70AP	1970-72 Polished	93.99 ea.

No Volume Discount.

Custom Radiator Covers

This custom radiator top panel offers a totally unique look and will keep your engine compartment neat and clean looking!

ARP-68A3B	1968-75 3 Bolt Black Anodized	83.99 kit
ARP-68A3C	1968-75 3 Bolt Clear Anodized	83.99 kit
ARP-68A3P	1968-75 3 Bolt Polished	93.99 kit
ARP-68A4B	1968-75 4 Bolt Black Anodized	83.99 kit
ARP-68A4C	1968-75 4 Bolt Clear Anodized	83.99 kit
ARP-68A4P	1968-75 4 Bolt Polished	93.99 kit

No Volume Discount.



AVG-68AC



AVG-70AB



ARP-68A4B



GCS-S9427

Chrome Radiator Top Panel

This chrome plated steel radiator top panel will add a nice custom touch to your show car! Complete with hardware.

GCS-S9427	1968-73 3 Bolt 24"	20.99 ea.
GCS-S9428	1968-73 4 Bolt 31-1/8"	36.99 ea.



AP-789K

Radiator Install Kit

This kit will make it easy to install the radiator on your Chevelle. Includes a brand new radiator top mounting panel, bolts and mounting pads.

AP-789K	1968-72 w/ 4 Row	47.43 kit
---------	------------------	-----------



AP-789

Radiator Top Panel

Correct 4 bolt hole reproduction radiator top panel.

AP-789	1968-72 All	32.95 ea.
AP-789-OE	1968-72 All OEM Style	65.95 ea.
AP-689	1968-72 All 3 Bolt w/o AC	24.95 ea.
AB-6872	Retaining Bolts (4)	2.95 kit



AAC-6072



AAC-6415

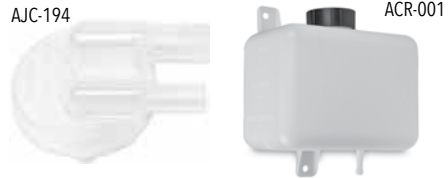

AJC-194

ACR-001

Universal Coolant Reservoir

Perfect for muscle cars that did not come with a factory reservoir. Compact size. Easy to mount anywhere. 6" wide, 4" deep, 5" tall.

ACR-001	All	11.99 ea.
---------	-----	-----------

Radiator Overflow Jar Cap

Correct reproduction featuring "ENGINE COOLANT ONLY".

AJC-194	1974 All 2-1/16" Id	7.95 ea.
---------	---------------------	----------

1978-88 Radiator Overflow Jars

Excellent reproductions of the two radiator overflow jars used on various 78-88 GM G-bodies.

AQJ-692	1978-88 1st Design	39.95 ea.
AQJ-470	1978-88 2nd Design	29.95 ea.



AOF-172

Stainless Overflow Tank

This polished stainless steel universal fluid reservoir is perfect for older muscle cars that did not come from the factory with a coolant recovery tank.

AOF-103	10" x 3"	54.99 ea.
AOF-132	13" x 2"	54.99 pr.
AOF-152	15" x 2"	54.99 ea.
AOF-172	17" x 2"	54.99 ea.

Note: 1/4 in. Hose Barb Inlet/Outlet.



ATE-4100

ATE-6041

Radiator Mounting Pads

Correct upper and lower rubber pads for mounting your radiator into the support. Lower pads feature steel cores.

ATE-6041	1968-72 Upper	9.95 pr.
ATE-4100	1968-72 Lower	9.95 pr.
ATE-65B	1968-72 3 Row & Small Block	9.99 ea.

CPN-0638



Radiator Overflow Hose OEM

Correct thin walled ribbed hose as original.

CPN-0638	1964-77	2.95 per ft
----------	---------	-------------

AXP-1106



Radiator Petcock

Correct gold colored fluted end drain valve for radiator.

AXP-1106	1964-77 All	4.95 ea.
----------	-------------	----------

CPX-8739



Radiator Hose Retaining Clip

Correct clip for retaining overflow hose.

CPX-8739	1964-72	12.95 ea.
----------	---------	-----------



Radiator Support Show Panels

This radiator support show panel seals up the unsightly area between the front of the radiator support and the header panel. It can be installed in about 15 minutes with no modification and will really make your engine compartment look clean and neat. Available with a number of popular logos. Add the appropriate letter for your choice of finish.

B = Black Anodized C = Clear Anodized Satin Silver P = Polished

1964 Chevelle / El Camino		B or C	P
ASP-64ASS_	1964 SS.....	155.99 ea.....	176.99 ea.
ASP-64ACV_	1964 "Chevelle" w/ Year.....	155.99 ea.....	176.99 ea.
ASP-64ABW_	1964 Bowtie.....	155.99 ea.....	176.99 ea.
ASP-64ABC_	1964 Bowtie/Chevrolet.....	155.99 ea.....	176.99 ea.
ASP-64ACH_	1964 Chevrolet.....	155.99 ea.....	176.99 ea.
ASP-64AMA_	1964 "Malibu" w/ Year.....	155.99 ea.....	176.99 ea.
ASP-64A_	1964 Plain.....	124.99 ea.....	142.99 ea.

1965 Chevelle / El Camino		B or C	P
ASP-65ASS_	1965 SS.....	155.99 ea.....	176.99 ea.
ASP-65ACV_	1965 "Chevelle" w/ Year.....	155.99 ea.....	176.99 ea.
ASP-65ABW_	1965 Bowtie.....	155.99 ea.....	176.99 ea.
ASP-65ABC_	1965 Bowtie/Chevrolet.....	155.99 ea.....	176.99 ea.
ASP-65ACH_	1965 Chevrolet.....	155.99 ea.....	176.99 ea.
ASP-65AMA_	1965 "Malibu" w/ Year.....	155.99 ea.....	176.99 ea.
ASP-65AMS_	1965 "Malibu SS" w/ Year.....	155.99 ea.....	176.99 ea.
ASP-65A_	1965 Plain.....	124.99 ea.....	142.99 ea.

1966 Chevelle / El Camino		B or C	P
ASP-66ASS_	1966 SS.....	155.99 ea.....	176.99 ea.
ASP-66ACV_	1966 "Chevelle" w/ Bowtie.....	155.99 ea.....	176.99 ea.
ASP-66ABW_	1966 Bowtie.....	155.99 ea.....	176.99 ea.
ASP-66ABC_	1966 Bowtie/Chevrolet.....	155.99 ea.....	176.99 ea.
ASP-66ACH_	1966 Chevrolet.....	155.99 ea.....	176.99 ea.
ASP-66AMA_	1966 "Malibu" w/ Bowtie.....	155.99 ea.....	176.99 ea.
ASP-66A_	1966 Plain.....	124.99 ea.....	142.99 ea.

Plain Anodized Shown in 1971 Chevelle.

1967 Chevelle / El Camino		B or C	P
ASP-67ASS_	1967 SS.....	155.99 ea.....	155.99 ea.
ASP-67ACV_	1967 "Chevelle" w/ Year.....	155.99 ea.....	155.99 ea.
ASP-67ABW_	1967 Bowtie.....	155.99 ea.....	155.99 ea.
ASP-67ABC_	1967 Bowtie/Chevrolet.....	155.99 ea.....	155.99 ea.
ASP-67ACH_	1967 Chevrolet.....	155.99 ea.....	155.99 ea.
ASP-67AMA_	1967 "Malibu" w/ Year.....	155.99 ea.....	155.99 ea.
ASP-67A_	1967 Plain.....	124.99 ea.....	124.99 ea.

1968-69 Chevelle / El Camino		B or C	P
ASP-68ASS_	1968-69 SS.....	197.99 ea.....	207.99 ea.
ASP-68ACV_	1968 "Chevelle" w/ Year.....	197.99 ea.....	207.99 ea.
ASP-69ACV_	1969 "Chevelle" w/ Year.....	197.99 ea.....	207.99 ea.
ASP-68ABW_	1968-69 Bowtie.....	197.99 ea.....	207.99 ea.
ASP-68ABC_	1968-69 Bowtie/Chevrolet.....	197.99 ea.....	207.99 ea.
ASP-68ACH_	1968-69 Chevrolet.....	197.99 ea.....	207.99 ea.
ASP-68AHB_	1968-69 Heartbeat of America.....	197.99 ea.....	207.99 ea.
ASP-68ABM_	1968-69 Ball Milled.....	201.99 ea.....	219.99 ea.
ASP-68A_	1968-69 Plain.....	169.99 ea.....	193.99 ea.

1970-72 Chevelle / El Camino		B or C	P
ASP-70ASS_	1970-72 SS.....	166.99 ea.....	176.99 ea.
ASP-70ACV_	1970 "Chevelle" w/ Year.....	166.99 ea.....	176.99 ea.
ASP-71ACV_	1971 "Chevelle" w/ Year.....	166.99 ea.....	176.99 ea.
ASP-72ACV_	1972 "Chevelle" w/ Year.....	166.99 ea.....	176.99 ea.
ASP-70ABW_	1970-72 Bowtie.....	166.99 ea.....	176.99 ea.
ASP-70ABC_	1970-72 Bowtie/Chevrolet.....	166.99 ea.....	176.99 ea.
ASP-70ACH_	1970-72 Chevrolet.....	166.99 ea.....	176.99 ea.
ASP-70AHB_	1970-72 Heartbeat of America.....	166.99 ea.....	176.99 ea.
ASP-70ABM_	1970-72 Ball Milled.....	145.99 ea.....	155.99 ea.
ASP-70A_	1970-72 Plain.....	124.99 ea.....	146.99 ea.

HOSE-KITA64B



HOSE-KITA68B



HOSE-KITA69B



HOSE-KITA69BS



Radiator & Heater Hose Kits

These are complete Chevelle radiator and heater hose kit includes (1) upper radiator hose with GM numbers, (1) lower radiator hose with GM numbers and (1) heater hose with GM numbers. This convenient kit allows you to replace all three of your hoses for a discounted kit price!

HOSE-KITA64B	1964-67 BB.....	44.92 kit
HOSE-KITA68B	1968 BB.....	44.92 kit
HOSE-KITA69B	1969-72 BB.....	47.47 kit
HOSE-KITA69BS	1969-72 BB w/ AC SHP.....	47.47 kit

All hose kits come with GM logo heater hoses.

BUY'N SAVE
WITH KITS

RADIATOR HOSES



Upper Radiator Hoses GM Licensed

Reproduction upper radiator hoses featuring the correct GM part numbers and ID codes!



	CPH-0687	
	CPH-0688	
	CPH-0687	1964-65 SB..... 16.95 ea.
	CPH-0688	1964-65 SB AC..... 16.95 ea.
	CPH-0700	1965 SB SHP..... 16.95 ea.
	CPH-8956	
	CPH-2883	1966-67 SB..... 16.95 ea.
	CPH-2883	1966-67 SB AC..... 16.95 ea.
	CPH-9670	1966-67 SB SHP..... 16.95 ea.
	CPH-3106	
	CPH-3106	1966-67 BB..... 16.95 ea.
	CPH-2229	
	CPH-2229	1968-72 SB Manual..... 16.95 ea.

	CPH-2396	
	CPH-2396	1968-72 SB Auto..... 16.95 ea.
	CPH-2453	
	CPH-2453	1969-72 BB SHP or AC..... 16.95 ea.
	CPH-7227	
	CPH-7227	1968-72 BB..... 16.95 ea.

Can be used with most V8 with oversized radiators. Trim to fit.

Lower Radiator Hoses GM Licensed

Reproduction lower radiator hoses featuring the correct GM part numbers and ID codes!

	CPH-9301	
	CPH-9301	1964-67 SB..... 16.95 ea.
	CPH-9303	
	CPH-9303	1964-67 SB w/ SHP Special High Performance..... 16.95 ea.
	CPH-9488	
	CPH-2394	1968 SB..... 16.95 ea.
	CPH-9488	1969-72 SB..... 16.95 ea.
	CPH-1814	
	CPH-1814	1966-67 BB..... 16.95 ea.
	CPH-7733	
	CPH-7733	1968 BB..... 16.95 ea.
	CPH-9188	1969-72 BB..... 16.95 ea.



Heater Hoses

New officially licensed GM restoration heater hose sets. 1964-68 hoses feature correct GM with box logo and 1969-72 features correct black ribbed design.

	CPH-5834	1964-68..... 18.95 kit
	CPR-5834	1969-72..... 21.95 kit

GCS-S6676



Braided Hose Sleeve Kit

An economical way to get the look of braided hoses without the high cost! Kit includes 3' of vacuum line sleeve, 4' of fuel line sleeve, 4' of radiator hose sleeve, 12' of heater hose sleeve and matching aluminum clamp covers.

GCS-S6676	Kit w/ Red Fittings..... 49.99 kit
GCS-S6677	Kit w/ Blue Fittings..... 49.99 kit
GCS-S6678	Kit w/ Chrome Fittings..... 49.99 kit

Note: Sleeves can be cut with scissors. Vacuum line uses shrink tubing instead of aluminum fittings. Hose clamps are not included.

	AWN-058	
	APN-1060	
	AWN-134	
	AWN-1059	
	TUF-4450A	

Tuff Stuff Chrome Heater Hose/Bypass Nipples

Chrome plated heater hose/bypass hose fittings.

TUF-4450A	3/4" Long..... 10.99 ea.
TUF-4450B	3/4" Short..... 10.99 ea.
TUF-4450C	5/8" Short..... 10.99 ea.



Tower Clamp Kits

Original Witek Tower style clamps. These factory installed clamps were used on most GM cars. 1962-68 used tower clamps on the radiator hoses and spring clamps on the heater hoses. Cars built 1969 or later used all tower clamps.

CPX-6368	1964-68 (8)..... 22.95 kit
CPX-4796	1969-72 (8)..... 26.95 kit

OEM Quality Heater Cores

These OEM quality heater cores are made to factory specifications featuring copper brass cores soldered to the tanks as original. The seal kits are made from die cut foam as original to ensure a perfect seal.

Heater Cores

AHC-9040	1964-67 w/o AC.....	89.99 ea.
AHC-9040A	1964-67 w/ AC.....	105.99 ea.
AHC-9066	1968-72 w/o AC.....	69.99 ea.
AHC-9063	1968-72 w/ AC.....	59.99 ea.
AHC-CLAMP	1964-77 All*.....	19.99 pr.

*Not all cars came with the clamps. Please check your car before ordering.

Seals

JHC-7364	1964-72 w/o AC.....	29.99 ea.
JHC-7264	1964-67 w/ AC.....	29.99 ea.
JHC-7468	1968-72 w/ AC.....	29.99 ea.
JHC-7887E	1978-87 w/ AC.....	50.95 kit

Heater Core Clips

Correct spring steel heater core retaining clips that are used to mount the heater core into the heater box.

AHC-13641	1964-72.....	30.99 kit
-----------	--------------	-----------

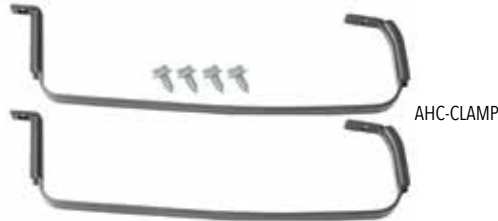

AHC-CLAMP



AHC-13641

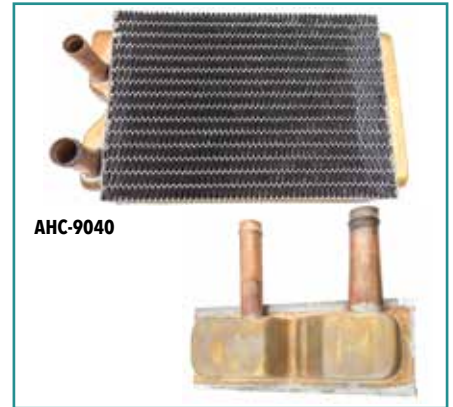

AHC-9040

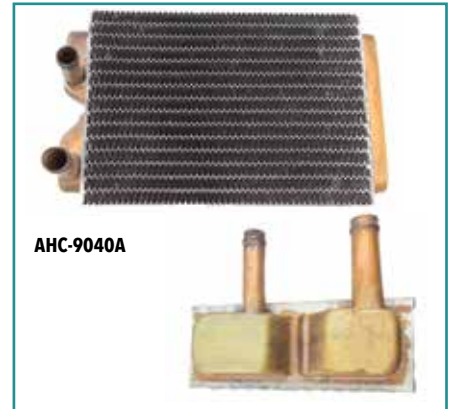

AHC-9040A



AHC-9066

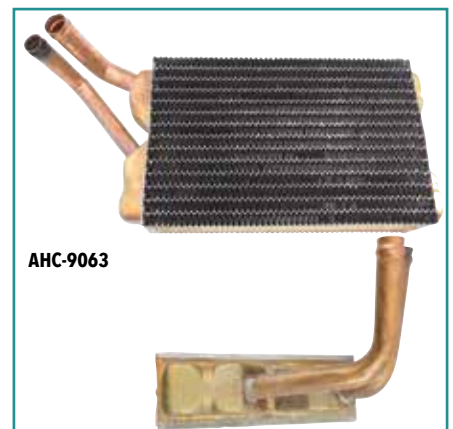

AHC-9063



AHC-KIT6

Heater Cores & Box Seal Kits

This kit includes an OEM heater core and neoprene seals. Components also available separately.

Kits

AHC-KIT5	1964-67 w/o AC.....	107.98 kit
AHC-KIT6	1964-67 w/ AC.....	122.38 kit
AHC-KIT7	1968-72 w/o AC.....	89.98 kit
AHC-KIT8	1968-72 w/ AC.....	80.98 kit

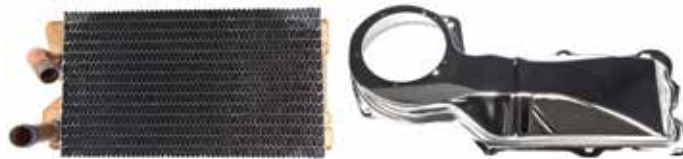

AHC-SUPERKIT7-SC

BUY 'N SAVE
WITH KITS



Heater Core & Box Super Kits

These new convenient heater core kits come with all the major components you need to refresh your ride.

These kits include a new OEM heater core, heater box cover, seal kit and factory caulking material.

AHC-SUPERKIT5-S	1964-67 w/o AC Black Cover.....	152.93 kit
AHC-SUPERKIT5-SC	1964-67 w/o AC Chrome Cover.....	188.93 kit
AHC-SUPERKIT7-S	1968-72 w/o AC Black Cover.....	134.93 kit
AHC-SUPERKIT7-SC	1968-72 w/o AC Chrome Cover.....	170.93 kit

No Volume Discount.

HEATING



ACV-1901

Heater Control Valve

New GM heater control valve for all Chevs with air conditioning. Correct gold plating.

ACV-1901	1964-70 w/ AC	46.95 ea.
AV-560	Screws (2).....	0.95 ea.



ATE-2059

Heater Hose Retainers

ATE-5416

Correct heater hose retainers for inside of passenger fender and top of alternator bracket.

ATE-2059	1964-75 RH Fender	6.99 ea.
ATE-5416	1964-75 Alt Bracket	6.99 ea.



ABM-1041W

Heater Blower Motor

New OEM replacement heater blower motor for cars with or without AC.

Motor Only

ABM-870	1964-72	44.99 ea.
---------	---------------	-----------

Motor with Cage

ABM-1041W	1964-72	70.18 ea.
-----------	---------------	-----------

Blower Motor Cage Only

ABM-CAGE	All	32.99 ea.
----------	-----------	-----------

Note: 5-1/8" diameter. and 2-3/8" deep

Grommets

AFG-64	1964-69	7.99 ea.
AFG-70	1970-72	13.99 ea.

Wire Clips

GWC-SPK	1964-77	13.99 pr.
---------	---------------	-----------



AV-1400G

Air Conditioning Plenum

Brand new air conditioning plenum.

AV-1400G	1970-72 w/ AC	89.95 ea.
----------	---------------------	-----------

Heater box not included.



IK-712DF

Dash Defroster Vent Plenum

This is a brand new improved OE style replacement defroster duct. Fits AC and heat only cars. SS or Malibu.

IK-712DF	1970-72	139.95 ea.
----------	---------------	------------



AHT-2328

Cowl Wiring Gutter

Correct plastic gutter used to hold engine harness against firewall.

AHT-2328	1964-72	8.95 ea.
ABH-102	Screws	0.95 pr.

ABR-71



Heater Blower Motor Resistors

Correct blower motor resistors.

ABR-71	1964-68 w/ AC	23.99 ea.
ABR-77	1964-72 w/o AC	21.99 ea.
ARS-304	Mounting Screws	0.95 pr.



DSE010902

DSE Heater Delete Plate

This bolt-in heater delete plate is an easy way to smooth your factory firewall when installing an aftermarket air conditioning system like Vintage Air. It can also give your Chevelle that rare original heater delete look. This panel is made of 18-gauge steel and stamped with pride in the USA. For original heater only cars.

DSE010902	1964-72	87.99 ea.
-----------	---------------	-----------



AXB-64-AC-DELETE

AXB-15241



1964-72 AC Delete Panels

These are Bolt-in panels to block off the AC openings on the firewall.

AXB-64-AC-DELETE	Aluminum	75.95 ea.
AXB-15241	Steel	49.99 pr.



UMI-4030

UMI-4030-B

UMI-4030-R

UMI Heater Box Delete Panels Aluminum

This heater delete panel is designed to eliminate both the heater box and blower unit from the engine bay. Removal of the heater box instantly removes 17 pounds from the front of your vehicle while cleaning up unwanted engine bay clutter. Product is CNC machined from 0.125 Aluminum plate. Installation: Requires removal of heater box. No drilling required and uses factory holes, some new hardware included. This item is for vehicles equipped without air conditioning.

UMI-4030	1964-72 w/o AC Bare Aluminum ..	89.95 ea.
UMI-4030-R	1964-72 w/o AC Red	109.95 ea.
UMI-4030-B	1964-72 w/o AC Black	109.95 ea.

Not eligible for free shipping.

AC Evaporator Case Drain Hose

This is the correct hose that goes into the bottom of the under hood AC evaporator case.

AEC-73D	All	13.99 ea.
---------	-----------	-----------



AHB-1400

Air Conditioning Box Cover

New injection molded condenser cover which mounts to the firewall.

AHB-1400	1968-72 w/ AC	199.95 ea.
----------	---------------------	------------

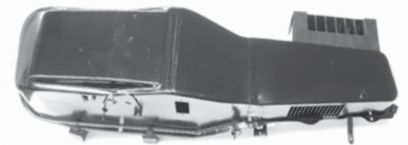

ACC-1400D

Heater Boxes

New complete inner heater box assemblies for under the dash.

ACC-1536	1966-67 w/o AC	269.95 ea.
ACC-1400D	1968-72 w/o AC	269.95 ea.
AC-1400F	1970-72 w/ AC	399.95 ea.

No Volume Discount.



IHD-14359

Heater Box Deflector

Used to deflect heat at the floor center hump.

IHD-14359	1968-72	25.99 ea.
-----------	---------------	-----------



AXB-9B

AC Delete Cover

This covers the large hole where your AC used to be and allows you to use your factory heater core when removing your AC.

AXB-9B	1968-72	109.95 ea.
--------	---------------	------------

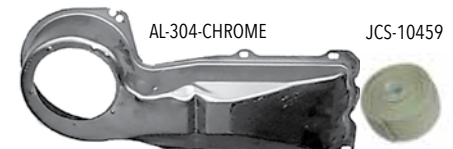

AL-304-CHROME

JCS-10459

Heater Box Cover

Brand new firewall heater box cover for all cars without air conditioning.

AL-304	1964-72	39.95 ea.
AL-304-CHROME	1964-72 Chrome	79.95 ea.
ALS-27	Retaining Nut.....	0.95 ea.
JCS-10459	Sealant.....	9.99 ea.

AIR CONDITIONING



VA-964464

Vintage Air SureFit kits are the most complete, bolt-in climate control systems available for your Chevelle. SureFit kits install easily and utilize most of the factory sheet metal and body features and are engineered as "vehicle specific" complete systems.

Our SureFit kits are designed to place the evaporator case and air duct hoses behind the dash for a factory-clean look. In most cases, the SureFit system will be controlled by your stock dash controls using our exclusive patented "Cable Converters." In some applications, a new "factory" look control panel is included with the kit.

All SureFit systems provide full OEM-style operations including air conditioning, floor or vent exit heating and a powerful dehumidified defroster. To retain a true factory look, the AC air exits through the factory dash louvers, if originally equipped in your car's dash. SureFit kits also offer the most complete and straightforward installations available anywhere. Our award-winning instruction booklets and carefully engineered system packages should make your SureFit installation job simple, fun and very cool!

The Gen IV is Vintage Air's most powerful and intelligent climate control system available for your Chevelle. The Gen IV uses an exclusive fully electronic microprocessor control system that eliminates cables or vacuum connections. Separate high-capacity copper parallel-flow heat coil and aluminum plate-and fin-cooling coils provide outstanding performance and instant temperature adjustments.

Complete kits include the evaporator unit and mounting brackets, louvers (where required), duct hose, wiring harness, patented Electronic Cable Converters, compressor, engine brackets, condenser with brackets, preformed refrigerant lines, drier, fittings, hardware and installation instructions.

Features Include:

- Fly-By-Wire fully electronic servo motor controls with no cables or capillary tube to route
- Infinite just-right-temperature air blending
- Infinite blower fan speed adjustment (3-speed on factory air models)
- High-volume dehumidified defrost mode
- Separate high-capacity aluminum plate & fin cooling coil
- Copper/brass CuproBraz™ parallel-flow heater coil
- Mounts behind the dash
- Uses your factory system controls with our patented Electronic Cable Converters
- Flat steel firewall cover panel
- Replacement molded glove box (reduced capacity)

VA-964464	1964-65 All With Factory Air.....	1389.99 kit
VA-961065	1964-65 All Without Factory Air.....	1389.99 kit
VA-964465	1966-67 All With Factory Air.....	1389.99 kit
VA-961066	1966-67 All Without Factory Air.....	1389.99 kit
VA-964471	1968-69 All With Factory Air.....	1389.99 kit
VA-961068	1968-69 All Without Factory Air.....	1389.99 kit
VA-965071	1970-72 All With Factory Air.....	1389.99 kit
VA-961071	1970-72 All Without Factory Air.....	1389.99 kit

No Volume Discount. Ships Oversize.

CAN NOT SHIP TO CALIFORNIA ADDRESS



ZAC-3

Air Conditioning Receiver Dryers

New Delco dryers.

ZAC-3	1964-67	69.95 ea.
ZAC-5	1968-72	51.95 ea.



ZAC-1470

Air Conditioning Condenser Radiator

New GM service replacement condensers. These units will require some modification.

ZAC-1470	1970-72	279.95 ea.
----------	---------------	------------



ZACL6970A

Air Conditioning Line

New pre-bent compressor line with correct fittings and compressor muffler.

ZACL-6970SB	1969-70 SB.....	179.95 ea.
ZACL6970A	1969-70 BB.....	179.95 ea.
ZACL7172A	1971-72	179.95 ea.

These lines will only work with correct original AC components.



ZAC-2005

Air Conditioning Duct Hose

Replace your old or missing air conditioning duct hose with this correct style flex hose. Measurements are when fully stretched.

ZAC-2005	All 2" Dia, 5' Long.....	9.99 ea.
ZAC-2505	All 2.5" Dia, 5' Long	9.99 ea.
ZAC-2010	All 2" Dia, 10' Long	16.99 ea.
ZAC-2510	All 2.5" Dia, 10' Long.....	16.99 ea.

Tuff Stuff AC Compressors

Tuff Stuff's black chrome plated AC compressor is quality built-in Cleveland, Ohio with 100% new components. The understated black chrome look complements any engine compartment. Black chrome finish will not discolor, rust or fade over time. Provides a consistent, eye-appealing finish for under hood accessories. These compressors are designed to fit late model or custom applications. These will not work with original factory brackets on your Chevelle.













TUF-4515NADP7

TUF-4517NA6G7	"Peanut Style"6 Groove Pulley.....	434.99 ea.
TUF-4517NADP7	"Peanut Style"2 Groove Pulley.....	434.99 ea.
TUF-4515NA6G7	"Sanden 508 Style"6 Groove Pulley.....	425.99 ea.
TUF-4515NADP7	"Sanden 508 Style"2 Groove Pulley.....	425.99 ea.

No Volume Discount.

Air Conditioning Brackets Big Block

OE style reproduction brackets for installing original Delco air conditioning compressors in all 1969-72 Chevilles with big blocks using long water pumps.

	ZAC-A1			ZAC-A4			ZAC-B2
		ZAC-A4	1969-70 Rear Compressor Plate.....	24.95 ea.			
ZAC-A1	1969-70 Rear Compressor Bracket.....	44.95 ea.			ZAC-B2	1970+ Front Bracket (on head).....	69.95 ea.
	ZAC-A2			ZAC-A5			ZAC-B3
		ZAC-A5	1969-71 Lower Bracket (to head).....	46.95 ea.			
ZAC-A2	1969-70 Front Bracket (on head).....	69.95 ea.			ZAC-B3	1970+ Front Compressor Bracket.....	42.95 ea.
	ZAC-A3			ZAC-A6			ZAC-B4
		ZAC-A6	1969-70 Rear Compressor Spacer.....	21.95 ea.			
ZAC-A3	1969-70 Front Compressor Bracket.....	44.95 ea.			ZAC-B4	1970+ Rear Compressor Plate.....	44.95 ea.
	ZAC-B1			ZAC-B5			
		ZAC-B1	1970+ Compressor to Intake Bracket ...	26.95 ea.			
ZAC-B1	1970+ Compressor to Intake Bracket ...	26.95 ea.			ZAC-B5	1972+ Lower Bracket (to head).....	44.95 ea.

SAVE BIG!
WHEN YOU BUY THE KIT.

Buy a complete set of big block air conditioning brackets and save! The design changed midway through 1970, so be sure to check your original brackets for early style (ZAC-AKIT) or late style (ZAC-BKIT).

ZAC-AKIT	1969-70 BB.....	228.33 kit
ZAC-BKIT	1970-71 BB.....	208.58 kit
ZAC-BKIT2	1972 BB.....	206.78 kit

