

**AIR CLEANERS**



GCS-S6915

**Ball Milled Air Cleaner**

Highly polished ball milled aluminum 14" air cleaner. Includes washable 3" filter.

GCS-S6915 Flat Base Flames .....94.99 kit  
GCS-S6905X Drop Base Flames ..... 104.99 kit  
*Note: 5-1/8" carb opening. Does not include stud, wing nut or gasket.*



GCS-S6723

**Finned Aluminum Air Cleaner - Round**

Highly polished finned aluminum 14" air cleaner. Includes washable 3" filter.

GCS-S6723 Flat Base Round ..... 105.99 kit  
GCS-S6725 Drop Base Round ..... 105.99 kit  
*Note: 5-1/8" carb opening. Includes mounting stud. Does not include wing nut or gasket.*



ACC-3377

**Air Cleaner Dual Snorkel L-79**

Reproduction of this hard to find chrome dual snorkel, which was installed on all L79 (327 cu in 350HP) Chevelles and El Caminos. Complete with base, lid, filter and flame arrester.

ACC-3377 1965-67 L79 Complete..... 299.99 kit  
AL79-LIDV 1965-67 L79 Chrome Lid Only ... 189.95 ea.  
*No Volume Discount.*



GCS-S2194



GCS-S2194C

**Retro Style Air Cleaner**

This retro style hot rod air cleaner assembly is constructed of steel and is a great inexpensive custom touch to any street machine or sleeper. This filter kit includes a 3" paper air filter and the mounting stud with chrome wing nut.

GCS-S2194 All Black..... 168.99 kit  
GCS-S2194C All Chrome ..... 198.99 kit



GCS-S6320

**Finned Aluminum Air Cleaner - Oval**

Highly polished finned aluminum 12" air cleaner. Includes washable 2" filter.

GCS-S6320 Flat Base.....72.99 kit  
*Note: 5-1/8" carb opening. Includes mounting stud. Does not include wing nut or gasket.*



ATW-3359

**Small Block Air Cleaner Assembly**

Exceptional quality reproduction of the original small block closed element air cleaner assembly for 4 bbl. carburetors with 4-3/8" throat size. Complete with base, lid with horn and filter element.

ATW-3359 1964-65 Complete Assembly ..... 149.95 kit  
ATW-3361 1966-67 Complete Assembly ..... 145.95 kit  
*No Volume Discount.*



ACQ-1220N



ATE-3907

**Open Element Air Cleaner**

Excellent reproduction of the original GM open element air cleaner assembly. Complete base with elbow assembly, chrome plated lid and AC Delco filter. Will fit most V8s with 4 bbl. carburetor.

ATE-3907 Complete Kit .....84.99 kit  
ACQ-1224 Chrome Lid Only 14"..... 36.95 ea.  
ACQ-1220N Chrome Lid Only  
w/ Service Instructions ..... 59.95 ea.  
AAC-8864 Base Only w/ Elbow Assembly..... 54.95 ea.



GCS-S8005X

**Stainless Steel Air Cleaner**

Highly polished stainless steel 14" air cleaner. Includes washable 3" filter.

GCS-S8005X Drop Base Stainless.....62.99 kit  
GCS-10095 Holley Black .....29.95 kit  
GCS-10099 Edelbrock Black.....29.95 kit  
*Note: 5-1/8" carb opening. Includes mounting stud and chrome wing nut. Does not include gasket.*



ATW-3361



AM-3360



AM-3362

**Big Block Air Cleaner Assembly**

Reproduction of the original big block air cleaner assembly complete with base, lid with horn and filter element.

|          |                               |            |
|----------|-------------------------------|------------|
| AM-3362  | 1966 396/325 HP.....          | 149.95 kit |
| AM-3360  | 1967 396/325 or 350 HP .....  | 149.95 kit |
| AM-3368  | 1966-67 Chrome Lid Only ..... | 74.99 ea.  |
| ACQ-1462 | Black Lid Only 17".....       | 49.99 ea.  |



ACQ-1260



ACQ-1260Z

**Cowl Induction Air Cleaner**

Reproduction of original GM including base, lid and filter.

|           |                                  |            |
|-----------|----------------------------------|------------|
| ACQ-1260  | Complete Kit w/ Black Lid .....  | 134.99 kit |
| ACQ-1260Z | Complete Kit w/ Chrome Lid ..... | 149.99 kit |
| ACQ-60    | Black Lid Only 14".....          | 29.99 ea.  |
| ACQ-1224  | Chrome Lid Only 14".....         | 36.95 ea.  |

\*Will not work with HEI



GCS-S2008

**Air Cleaner Risers**

CNC machined aluminum air cleaner riser with O-ring.

|           |            |           |
|-----------|------------|-----------|
| GCS-S2008 | 1/4" ..... | 12.99 kit |
| GCS-S2009 | 1/2" ..... | 12.99 kit |



ACL-1267

**Air Cleaner Rubber Seal**

Reproduction rubber seal.

|          |                             |           |
|----------|-----------------------------|-----------|
| ACL-1267 | 1970-72 Cowl Induction..... | 24.99 ea. |
|----------|-----------------------------|-----------|



ACX-400

**REAR**

**Air Cleaner Flange**

Correct steel flange for top of air cleaner.

|         |                      |           |
|---------|----------------------|-----------|
| ACX-400 | 1970-72 Flange ..... | 27.99 ea. |
| HOJ-409 | 1970-72 Decal .....  | 4.99 ea.  |



AP-2B

**Air Cleaner Gasket**

Correct paper gasket for sealing air cleaner base to carburetor.

|       |                |          |
|-------|----------------|----------|
| AP-2B | All 2 bbl..... | 3.95 ea. |
| AP-4B | All 4 bbl..... | 4.95 ea. |



HCO-396



ACQ-454-425

**"Turbo Jet" Air Cleaner Lids**

Our chrome 14" air cleaner lid (ACQ-1224) featuring high quality die cast "Turbo Jet" medallions.

|             |                  |            |
|-------------|------------------|------------|
| ACQ-396     | 396 .....        | 99.99 ea.  |
| ACQ-454     | 454 .....        | 99.99 ea.  |
| ACQ-396-375 | 396, 375 Hp..... | 155.00 ea. |
| ACQ-454-425 | 454, 425 Hp..... | 155.00 ea. |
| ACQ-454-450 | 454, 450 Hp..... | 155.00 ea. |

Can be used with open element air cleaners or cowl induction.



APX-1400



ATE-5695



APX-7700



APJ-2153



AP-315



AP-317

**Wing Nuts, Flame Arrester & Studs**

|          |                      |          |
|----------|----------------------|----------|
| APX-1400 | Chrome Wing Nut..... | 4.95 ea. |
| APX-7700 | Black Wing Nut ..... | 4.95 ea. |
| ATE-5695 | Flame Arrester.....  | 8.95 ea. |

**Carburetor Studs**

|          |                                       |           |
|----------|---------------------------------------|-----------|
| APJ-2153 | All w/ Holley Open Element.....       | 12.95 ea. |
| AP-315   | All w/ Q-Jet.....                     | 12.95 ea. |
| AP-315   | 1970-72 Holley w/ Cowl Induction..... | 12.95 ea. |
| AP-317   | 1970-72 Q-Jet w/ Cowl Induction.....  | 13.95 ea. |
| ATE-5256 | Universal w/ Point End.....           | 8.95 ea.  |



**Air Filter Reproduction**

Reproduction of the original style with "square mesh" design and original GM wording (silk screened) or AC Delco replacement style air filters.

|         |                              |           |
|---------|------------------------------|-----------|
| N-1012  | 1967-69 Diagonal Mesh.....   | 32.95 ea. |
| N-1010  | 1970-72 Horizontal Mesh..... | 32.95 ea. |
| ACW-212 | All 14" AC Delco .....       | 11.99 ea. |

**K&N Air Filter Kits**

K&N's custom air cleaner assemblies are designed with the racer in mind. They incorporate good looks as well as the superior air flow that you expect from K&N. These custom air cleaner assemblies are designed for use with any engine that uses a round element air cleaner housing. They incorporate K&N Air Filters and provide more air flow than other assemblies of this type. Each complete assembly comes with base, element and top plate. Provides more air flow to the engine, designed to increase horsepower, washable and reusable air filters.



**Chrome Lid Drop Base**

|            |                                      |            |
|------------|--------------------------------------|------------|
| KN-60-1280 | 1962-79 14X3", 1-1/4" Drop Base..... | 95.99 ea.  |
| KN-60-1290 | 1962-79 14X4", 1-1/4" Drop Base...   | 130.99 ea. |
| KN-60-1300 | 1962-79 14X5", 1-1/4" Drop Base...   | 125.99 ea. |
| KN-60-1310 | 1962-79 14X6", 1-1/4" Drop Base...   | 123.99 ea. |
| KN-60-1430 | 1962-79 14X3", 7/8" Drop Base.....   | 116.99 ea. |
| KN-60-1440 | 1962-79 14X4", 7/8" Drop Base.....   | 118.99 ea. |
| KN-60-1450 | 1962-79 14X5", 7/8" Drop Base.....   | 127.99 ea. |
| KN-60-1460 | 1962-79 14X6", 7/8" Drop Base.....   | 129.99 ea. |

**Chrome Lid Raised Base**

|            |   |            |
|------------|---|------------|
| KN-60-1263 | 1962-79 14X2 5/16", 9/16"<br>Raised Base..... | 118.99 ea. |
| KN-60-1264 | 1962-79 14X3", 9/16" Raised Base.             | 104.99 ea. |
| KN-60-1260 | 1962-79 14X4", 9/16" Raised Base.             | 134.99 ea. |
| KN-60-1270 | 1962-79 14X4", 9/16" Raised Base.             | 145.99 ea. |

**X-Stream w/ Dropped Base**

|            |                                    |            |
|------------|------------------------------------|------------|
| KN-66-3050 | 1962-79 14X3" 7/8" Drop Base.....  | 172.99 ea. |
| KN-66-3040 | 1962-79 14X3", 1-1/4" Drop Base... | 131.99 ea. |
| KN-66-3060 | 1962-79 14X4", 1-1/4" Drop Base... | 140.99 ea. |
| KN-66-3070 | 1962-79 14X5", 1-1/4" Drop Base... | 187.99 ea. |

**X-Stream w/ Raised Base**

|            |   |            |
|------------|---|------------|
| KN-66-3000 | 1962-79 14X2 5/16", 9/16"<br>Raised Base..... | 174.99 ea. |
| KN-66-3010 | 1962-79 14X3", 9/16" Raised Base.             | 140.99 ea. |
| KN-66-3020 | 1962-79 14X4", 9/16" Raised Base.             | 187.99 ea. |
| KN-66-3030 | 1962-79 14X5", 9/16" Raised Base.             | 203.99 ea. |

**X-Stream Lid Only**

|              |                                      |           |
|--------------|--------------------------------------|-----------|
| KN-66-1401XB | 1962-79 14" w/ Blue Trim Ring .....  | 89.99 ea. |
| KN-66-1401XP | 1962-79 14" w/ Chrome Trim Ring...   | 80.99 ea. |
| KN-66-1401XR | 1962-79 14" w/ Red Trim Ring.....    | 89.99 ea. |
| KN-66-1401   | 1962-79 14" w/ Black Trim Ring ..... | 72.99 ea. |

**Replacement Air Filter Only**

|          |                                    |           |
|----------|------------------------------------|-----------|
| KN-E3750 | 1962-79 14x4 Washable Filter ..... | 66.99 ea. |
| KN-E3760 | 1962-79 14x5 Washable Filter ..... | 75.99 ea. |
| KN-E3770 | 1962-79 14x6 Washable Filter ..... | 91.99 ea. |

**Recharger Care Kits**

|            |                                 |           |
|------------|---------------------------------|-----------|
| KN-99-5000 | 1962-79 w/ Aerosol Can.....     | 13.99 ea. |
| KN-99-5050 | 1962-79 w/ Squeeze Bottle ..... | 13.99 ea. |

No Volume Discount.

**COWL INDUCTION**



ACX-72



ACX-72C

**BUY'N SAVE WITH KITS**

**Cowl Induction Air Cleaner Kit**

This complete kit can be added to our inner and outer door kit for a fully functioning system! Comes complete with base, filter, lid, steel flange and rubber seal! Choose from a black or chrome lid.

|         |                         |            |
|---------|-------------------------|------------|
| ACX-72  | 1970-72 Black Lid.....  | 169.17 kit |
| ACX-72C | 1970-72 Chrome Lid..... | 182.67 kit |

No Volume Discount.



ARA-4365

**Cowl Induction Spacer**

Correct spacer used on original intake manifold.

|          |              |           |
|----------|--------------|-----------|
| ARA-4365 | 1970-72..... | 29.99 ea. |
|----------|--------------|-----------|



AMH-8922

**Cowl Induction Harness**

Reproduction of original GM.

|          |              |           |
|----------|--------------|-----------|
| AMH-8922 | 1970-72..... | 49.99 ea. |
|----------|--------------|-----------|



**BUY'N SAVE WITH KITS**



**Cowl Induction Outer Door Kit**  
This kit contains: door brackets, hood door, door pivot bolts, pivot bushings, attaching screws, pod bracket, vacuum pod and vacuum hose.

ACX-970 1970-72 Outer Door Kit..... 116.71 kit  
*No Volume Discount.*



**BUY'N SAVE WITH KITS**



**Cowl Induction Inner Door Kit**  
This kit contains: inner flipper door, flipper door frame, flipper retaining clips, electric solenoid, pedal switch bracket, pedal switch, wiring harness and relay switch.

ACX-972 1970-72 Inner Door Kit..... 211.35 kit  
*No Volume Discount.*



**Hood Door Bracket Hardware**  
Correct set of four screws for attaching bracket to hood.

BX-1070 1970-72.....3.95 kit



**Hood Door Attaching Kit**  
Correct shouldered bolts with P head markings with nylon bushings.

ACL-5588 1970-72.....8.95 kit



**Valve Frame Door Clips**  
Correct set of three clips to attach the flipper door to the frame.

ACL-1684 1970-72.....5.99 kit



**Cowl Induction Hose**  
Correct non-collapsing OEM vacuum hose. (4 feet required)

AIH-100 Hose.....1.50 ea.  
BPX-2350 Retainer.....3.95 pr.



**Cowl Hood Solenoid**  
Correct electric solenoid.

ACI-3685 1970-72.....40.99 ea.  
AVN-101 1970-72 Screw.....0.95 pr.



**Cowl Hood Screen Screws**  
This is a set of 8 correct cowl hood screen attaching screws.

AX-907 1970-72.....5.95 kit



**Hood Valve Frame**  
Correct steel frame inside of hood to support the flipper door.

ACL-1430 1970-72.....26.99 ea.



**Hood Valve Frame Screws**  
This is a set of 6 correct screws to attach the hood valve frame.

BCX-130 1970-72.....5.95 kit



**Cowl Hood Door**  
Correct steel door.

ACL-3958 1970-72.....36.95 ea.



**Valve Frame (Flipper) Door**  
This is the electrically controlled air door which mounts to the valve frame.

ACX-012 1970-72.....14.99 ea.



**Hood Door Bracket**  
New reproduction brackets for mounting door to hood.

ACC-8585 1970-72.....19.99 pr.

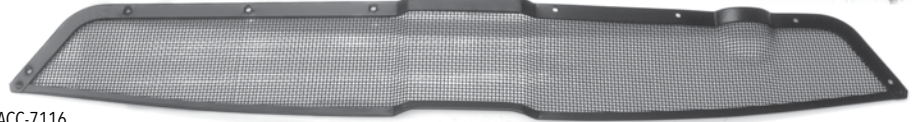

**Cowl Hood Screen**  
Correct steel screen attached to the rear of hood to keep debris out.

ACC-7116 1970-72.....29.95 ea.



**Cowl Vent Grilles**  
Correct plastic grilles to keep debris out of cowl.

N-4510 1968-72 non-AC.....24.95 kit  
N-4512 1968-72 w/ AC.....24.95 kit

**COWL INDUCTION** *continued*



AQW-296

**Cowl Hood Grommet**

Correct rubber grommet for routing wiring harness.

|         |         |          |
|---------|---------|----------|
| AQW-296 | 1970-72 | 8.99 ea. |
|---------|---------|----------|



ACC-8555

ATE-2101

**Kickdown**

Correct GM kickdown switch for TH400.

|           |                                  |           |
|-----------|----------------------------------|-----------|
| ATE-2101  | 1970-72 TH400 Switch             | 39.99 ea. |
| ACC-8555  | 1970-72 Switch Bracket           | 19.95 ea. |
| ATE-2101K | 1970-72 TH400 Switch Bracket Kit | 54.99 kit |
| 06145     | 1966-67 TH400 Harness            | 32.99 ea. |
| 11980     | 1968-69 TH400 Harness            | 33.99 ea. |
| 17565     | 1971-72 TH400 Harness            | 23.99 ea. |



AXL-913

**Flow Control Valve**

This is a correct, functional reproduction of the original valve.

|         |         |           |
|---------|---------|-----------|
| AXL-913 | 1970-72 | 23.95 ea. |
|---------|---------|-----------|



ACC-0417

**Vacuum Pod Actuator**

Monitors opening and closing of hood door.

|          |                 |           |
|----------|-----------------|-----------|
| ACC-0417 | 1970-72         | 28.95 ea. |
| AVN-101  | Screw (to door) | 0.95 pr.  |



BX-1070

**Vacuum Pod Bracket**

Correct bracket to hold actuator to hood.

|          |            |           |
|----------|------------|-----------|
| ACC-0418 | 1970-72    | 19.99 ea. |
| BX-1070  | Screws (4) | 3.95 kit  |



AEH-9602

**Valve Relay**

This relay sends the "hot" signal to solenoid.

|          |         |           |
|----------|---------|-----------|
| AEH-9602 | 1970-72 | 29.99 ea. |
|----------|---------|-----------|

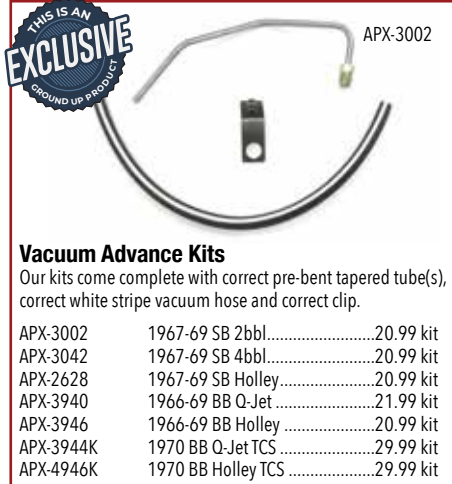

**Vacuum Advance Kits**

Our kits come complete with correct pre-bent tapered tube(s), correct white stripe vacuum hose and correct clip.

|           |                    |           |
|-----------|--------------------|-----------|
| APX-3002  | 1967-69 SB 2bbl    | 20.99 kit |
| APX-3042  | 1967-69 SB 4bbl    | 20.99 kit |
| APX-2628  | 1967-69 SB Holley  | 20.99 kit |
| APX-3940  | 1966-69 BB Q-Jet   | 21.99 kit |
| APX-3946  | 1966-69 BB Holley  | 20.99 kit |
| APX-3944K | 1970 BB Q-Jet TCS  | 29.99 kit |
| APX-4946K | 1970 BB Holley TCS | 29.99 kit |



APR-4060 AX-301 CPN-100

**Vacuum Advance Clips**

Correct clip to retain tube to intake manifold.

|          |             |             |
|----------|-------------|-------------|
| APR-4060 | All V8      | 8.95 ea.    |
| AX-301   | 1970 w/ TCS | 13.95 ea.   |
| CPN-100  | Hose        | 1.95 per ft |

GCS-S4973



**Vacuum Advance Cover**

This vacuum advance pod cover will give your distributor that show car look. Fits most GM distributors.

|           |        |          |
|-----------|--------|----------|
| GCS-S4973 | Chrome | 3.99 ea. |
|-----------|--------|----------|



**Choke Kits**

New reproductions! Our kits come complete with thermal coil, cover, rod, retaining clip and screw.

|          |                   |           |
|----------|-------------------|-----------|
| ACK-1679 | 1967-69 SB Q-Jet  | 36.95 kit |
| ACK-8889 | 1966-69 BB Q-Jet  | 36.95 kit |
| ACK-1669 | 1967-69 BB Holley | 36.95 kit |
| ACK-7072 | 1970-72 BB Q-Jet  | 36.95 kit |
| ACK-7071 | 1970-72 BB Holley | 36.95 kit |

**CARBURETOR**



AFP-4221

**Carburetor Base Gaskets & Shields**

Correct "stamped" gasket and stainless steel shield.

|                |                      |           |
|----------------|----------------------|-----------|
| <b>Gaskets</b> |                      |           |
| AFP-4221       | 1964-69 4 bbl. Q-Jet | 6.95 ea.  |
| AFP-4219       | 1970-72 4 bbl. Q-Jet | 6.95 ea.  |
| AFP-4222       | 1965-72 All Holley   | 6.95 ea.  |
| <b>Shield</b>  |                      |           |
| ABB-7401       | 1964-72 All Q-Jet    | 12.95 ea. |



DEMON-1900



**Demon Carburetors**

WICKED POWER! The ALL NEW Street Demon® redefines the street carburetor with clean looks and ease of use! The Street Demon offers enthusiasts a straightforward carburetor designed to deliver a stable idle, amazingly crisp throttle response and smooth performance. Its optimized calibration and dual mounting pattern make it Run-Ready™. Designed for use on most stock to mildly modified V8s! These carbs feature vacuum secondaries and an electric choke.

**625 CFM Carburetors**

|              |                                |            |
|--------------|--------------------------------|------------|
| DEMON-1900   | Silver w/ Aluminum Float Bowl  | 337.99 ea. |
| DEMON-1901   | Silver w/ Composite Float Bowl | 337.99 ea. |
| DEMON-1901BK | Black w/ Aluminum Float Bowl   | 406.99 ea. |

**750 CFM Carburetors**

|            |                                |            |
|------------|--------------------------------|------------|
| DEMON-1903 | Silver w/ Aluminum Float Bowl  | 374.99 ea. |
| DEMON-1904 | Silver w/ Composite Float Bowl | 374.99 ea. |

No Volume Discount.



HOL-0-1850SA



**Holley Carburetors**

Holley is one of the most trusted carburetors of all time! Its 600 CFM of airflow, vacuum secondaries, single fuel inlet and mechanical or electric choke makes it amazingly universal. The 4160 carbs are constructed from aluminum which compared to its zinc counterpart equates to a weight savings of 40%! Being aluminum also means it will hold its shine and can be hand polished for a custom look! Don't trust your performance to just anyone, Holley is the only modular carburetor company that has been in business for over 100 years and has powered every NASCAR champion since the 60's.

|               |                                 |            |
|---------------|---------------------------------|------------|
| HOL-0-1850SA  | All 4160 600 CFM Manual Choke   | 346.99 ea. |
| HOL-0-80457SA | All 4160 600 CFM Electric Choke | 359.99 ea. |
| HOL-0-80670   | All 4150 670 CFM Electric Choke | 495.99 ea. |

No Volume Discount.



**Quick Fuel Technology Carburetors**  
 "Innovators in fuel systems" is more than just a by-line. Quick Fuel Technology, since its inception in 1998, has grown exponentially in its 21 years of business culminating into the benchmark by which performance carburetors are measured.



QF-HR-600



QF-SS-650



QF-Q-750

**Hot Rod Series** is a versatile performer designed for the most discerning street enthusiast. Featuring lightweight die-cast aluminum components, the HR-Series offer all the tunability you would expect from more expensive racing carburetors, including changeable bleeds, idle feed, power valve channel restrictions, and four-corner idle. Offered in either vacuum or mechanical secondary models, all Hot Rod Series carburetors feature electric chokes and dual metering blocks for added performance. Now available in a 450 cfm model for applications with small displacement engines.

- All models feature a fully adjustable electric choke for easy starting
- Dual metering blocks w/ 4-corner idle for smooth and efficient idle quality
- Screw-in air bleeds and idle feed restrictions for quick unsurpassed tuning capability
- Dual inlet fuel bowls with sight glass windows for safe, easy float adjustment
- Universal throttle lever with sealed throttle shafts for smooth operation • Tunable secondary opening rate
- Tumble polished for long lasting shine

**4150 Carburetors Square Bore**

|              |                        |            |
|--------------|------------------------|------------|
| QF-HR-600    | 600CFM Mechanical..... | 517.99 ea. |
| QF-HR-650    | 650CFM Mechanical..... | 517.99 ea. |
| QF-HR-750    | 750CFM Mechanical..... | 571.99 ea. |
| QF-HR-850    | 850CFM Mechanical..... | 607.99 ea. |
| QF-HR-680-VS | 680CFM Vacuum .....    | 497.99 ea. |
| QF-HR-780-VS | 780CFM Vacuum .....    | 514.99 ea. |

No Volume Discount.



QF-SL-450-VS



QF-SQ-650



QF-FX-4710

**Slayer Series** street carburetors are designed with many of the same innovations and features that are built into all QFT™ race-winning carburetors, including changeable air bleeds and power valve channel restrictions. It's designed with a secondary metering plate with changeable jets, and features all aluminum components for additional weight savings. All Slayer Series carburetors are equipped with universal throttle lever to accommodate a variety of models.

- Vacuum Secondaries • Electric Choke
- Single Metering Block • Secondary Metering Plate
- Cast Aluminum Throttle Body • Single Sight Glass Windows
- Changeable Air Bleeds • Adjustable Needles & Seats

**4160 Carburetors Square Bore Dual Inlet**

|              |                    |            |
|--------------|--------------------|------------|
| QF-SL-450-VS | 450CFM Vacuum..... | 358.99 ea. |
| QF-SL-600-VS | 600CFM Vacuum..... | 358.99 ea. |
| QF-SL-750-VS | 750CFM Vacuum..... | 389.99 ea. |

**4160 Carburetors Square Bore Single Inlet**

|             |                           |            |
|-------------|---------------------------|------------|
| QF-SL-1957E | 600CFM Vacuum Silver..... | 358.99 ea. |
| QF-BD-1957  | 600CFM Vacuum Black ..... | 435.99 ea. |

No Volume Discount.

**Super Street Series** carburetors combine street-friendly drivability and track-capable performance in a single value-oriented package. Setting them apart from ordinary street carbs, they feature billet dual metering blocks and throttle-bodies that offer tighter tolerances and eliminate porosity. Not only are Super Street Series carbs available with both vacuum or mechanical secondaries, QFT™ also offers models designed and calibrated specifically for E85 fuel and blow-through forced induction applications. Running alternative fuel or boost no longer requires an expensive custom carburetor. All SS-Series carburetors are equipped with universal throttle levers to accommodate a variety of models. Bolting on the ultimate street/strip carburetor has never been easier.

- Red billet dual metering blocks & silver billet throttle bodies for improved durability
- Changeable idle, high-speed air bleeds & power valve restrictions
- Dual inlet fuel bowls with dual sight glass windows for easy float adjustment
- 4-Corner idle for precise idle and smooth transition
- Fully-adjustable electric choke with easy one wire hookup
- Race-ready with notched secondary floats and jet extensions
- Polished or Black Diamond™ finish available (some models)

**4150 Carburetors Square Bore**

|              |                               |            |
|--------------|-------------------------------|------------|
| QF-SS-650    | 650CFM Mechanical Silver..... | 695.99 ea. |
| QF-SS-750    | 750CFM Mechanical Silver..... | 695.99 ea. |
| QF-SS-850    | 850CFM Mechanical Silver..... | 695.99 ea. |
| QF-BD-750    | 750CFM Mechanical Black.....  | 747.99 ea. |
| QF-SS-680-VS | 680CFM Vacuum Silver.....     | 646.99 ea. |
| QF-SS-780-VS | 780CFM Vacuum Silver.....     | 646.99 ea. |

No Volume Discount.

**Street-Q** carburetor is intended to deliver legendary Q-Series performance to hardcore street enthusiasts at a reduced price. The major differences between the Street-Q and the race-bred Q-Series is the substitution of cast metering blocks and a cast throttle body in place of fully-machined billet components. All of the critical functionality is retained – 2-circuit metering, downleg boosters, changeable idle and high-speed air bleeds and 4-corner idle. A universal throttle lever to accommodate a variety of models.

- Lightweight die-cast aluminum components
- Changeable idle and high-speed air bleeds
- 2-circuit metering – 4-Corner idle system
- Downleg boosters
- 700-R4 mounting holes

**4150 Carburetors Square Bore**

|           |                               |            |
|-----------|-------------------------------|------------|
| QF-SQ-650 | 650CFM Mechanical Silver..... | 554.99 ea. |
| QF-SQ-750 | 750CFM Mechanical Silver..... | 596.99 ea. |
| QF-SQ-850 | 850CFM Mechanical Silver..... | 612.99 ea. |
| QF-SQ-950 | 950CFM Mechanical Silver..... | 626.99 ea. |

No Volume Discount.

**Q-Series Race** carburetors are purpose-built for the dragstrip. To combat the g's experienced during hard launches, Q-Series carbs are equipped with notched floats and secondary jet extensions. The high-flow aluminum main body isn't just lightweight, but it also features recessed air bleed cavities for improved air flow. Die-cast venturi are machined to exacting tolerances for outstanding throttle response. Billet metering blocks ensure a uniform fuel curve, while throttle-bodies enhance durability. For those days when track conditions vary from one pass to the next, QFT's QuickLink system makes adjusting the secondaries easy on models equipped with mechanical secondaries. The Q-Series is our most comprehensive line of carburetors, with applications available for use with gasoline, methanol, and E85 fuels, forced induction, drag race, circle track, and comes in both vacuum and mechanical secondary models.

- Lightweight aluminum main body
- Mechanical secondary
- Aluminum fuel bowls with dual sight glass windows
- Billet metering blocks with 4-corner idle system
- Changeable idle feed and power valve channel restrictions
- PTFE coated and sealed shafts that have been slabbed for added air flow
- Red anodized billet metering blocks and throttle plate

**4150 Carburetors Square Bore**

|             |                                    |            |
|-------------|------------------------------------|------------|
| QF-Q-750    | 750CFM Mechanical Silver/Red.....  | 804.99 ea. |
| QF-Q-750-B2 | 750CFM Mechanical Silver/Red*..... | 862.99 ea. |
| QF-Q-850    | 850CFM Mechanical Silver/Red.....  | 862.99 ea. |
| QF-Q-950    | 950CFM Mechanical Silver/Red.....  | 918.99 ea. |
| QF-BD-Q-750 | 750CFM Mechanical Black/Black..... | 862.99 ea. |

\*Draw thru supercharger applications with 2 carbs.  
 No Volume Discount.

**QFX-Series** stands as the flagship model in QFT's lineup. Raised air horns improve entry angle into the venturi while ensuring uninterrupted flow over the air bleeds. Annular boosters with CNC-machined billet aluminum inserts provide increased air flow, a stronger signal, and less turbulence. QFX carbs offer unparalleled fuel atomization with annular boosters specific for either gas, methanol, or E85 fuels. Five-emulsion billet metering blocks and four-corner idle circuits offer flexible tunability that today's high-horsepower engines demand. Ready to run out of the box, the QFX-Series carburetor will help you get to the winner's circle.

- QFX aluminum main body w/ raised venturi
- Billet aluminum metering blocks with screw in restrictions
- Aluminum fuel bowls with dual sight windows and fuel inlets
- Viton .130" Needles and Seats
- Billet Aluminum annular booster inserts
- QuickLink™ adjustable secondary opening adjustment
- Hand assembled and engine tested

**4500 Spread Bore Dominator Style**

|            |                                     |             |
|------------|-------------------------------------|-------------|
| QF-FX-4710 | 1150CFM Mechanical Black/Black..... | 1165.99 ea. |
|------------|-------------------------------------|-------------|

No Volume Discount.



BTE-1475



BMG-0095

**Carb Attaching Kits**

Correct OEM bolt kit for attaching carburetor to intake manifold.

|          |                   |          |
|----------|-------------------|----------|
| BMG-0095 | All w/Holley..... | 5.99 ea. |
| BTE-1475 | All w/Q-Jet.....  | 8.95 ea. |

AHL-516



**Carburetor Inlet Nuts**

Correct Holley carb fuel inlet nuts & washers.

|         |                    |           |
|---------|--------------------|-----------|
| AHL-516 | 5/16" (stock)..... | 12.99 ea. |
| AHL-38  | 3/8".....          | 12.99 ea. |

GCS-S2105



**Carburetor Velocity Stack**

High grade, chrome plated steel with a washable filter element.

|           |                  |           |
|-----------|------------------|-----------|
| GCS-S2105 | Most 4 bbl ..... | 83.99 kit |
|-----------|------------------|-----------|

Note: 5-1/8" carb opening.



MS142-08R



MS142-08CA

**EMS Billet Throttle Cable Brackets**

These Eddie Motorsports billet GM throttle cable brackets mount to the base of Holley carburetors. The kit includes the cable mount bracket, return springs and bracket and installation hardware.

**With 4150/4160 Series Carburetor**

|            |                             |           |
|------------|-----------------------------|-----------|
| MS142-08B  | 1964-77 Blue.....           | 77.99 kit |
| MS142-08R  | 1964-77 Red.....            | 77.99 kit |
| MS142-08BA | 1964-77 Black Anodized..... | 77.99 kit |
| MS142-08CA | 1964-77 Clear Anodized..... | 77.99 kit |

**With 4500 Series Carburetor**

|            |                             |            |
|------------|-----------------------------|------------|
| MS142-09B  | 1964-77 Blue.....           | 102.99 kit |
| MS142-09R  | 1964-77 Red.....            | 102.99 kit |
| MS142-09BA | 1964-77 Black Anodized..... | 102.99 kit |
| MS142-09CA | 1964-77 Clear Anodized..... | 102.99 kit |

No Volume Discount.

**CARBURETOR & RELATED**



N-424

**Accelerator Rod Kits**

For those using rods, our kits come complete with pre-bent rod, swivel, grommet, sleeve and hardware.

|          |                        |           |
|----------|------------------------|-----------|
| AR-4320  | 1964-67 SB 4 bbl*..... | 16.95 kit |
| N-425    | 1966-67 BB Q-Jet.....  | 39.95 kit |
| N-424    | 1966-67 BB Holley..... | 39.95 kit |
| APJ-1314 | 1964-67 Most.....      | 7.95 kit  |

\*may require slight modification.



3992376

3972619

**Accelerator Brackets**

Your choice of brackets with GM numbers or without GM numbers. Both fit as original.

|          |                                    |           |
|----------|------------------------------------|-----------|
| 3992376  | 1969-72 Q-Jet w/ GM Numbers.....   | 32.95 ea. |
| 3972619  | 1968-72 Holley w/ GM Numbers.....  | 32.95 ea. |
| AXK-68   | 1969-72 Q-Jet w/o GM Numbers.....  | 22.95 ea. |
| ADT-0014 | 1968-72 Holley w/o GM Numbers..... | 19.95 ea. |

ATH-3369KIT-H



**Accelerator Cable & Bracket Kit**

This new accelerator cable and bracket kit is the perfect solution for smooth operation when your originals are either worn or missing. This kit includes a reproduction accelerator cable, bracket and retaining clip.

|               |                                      |           |
|---------------|--------------------------------------|-----------|
| ATH-3369KIT-H | 1968-72 All BB/SB w/ SHP Holley..... | 41.27 kit |
|---------------|--------------------------------------|-----------|

No Volume Discount.



**Accelerator Cables**

Choose from GM service replacement cables or new reproductions complete with casings and bushings as original.

|          |                               |           |
|----------|-------------------------------|-----------|
| ATH-3863 | 1968-72 SB 2 bbl GM.....      | 34.99 ea. |
| ATH-2679 | 1968-72 SB 4 bbl GM.....      | 52.99 ea. |
| ATH-3862 | 1968-72 BB Q-Jet GM.....      | 39.99 ea. |
| ATH-3369 | 1968-72 BB Holley GM.....     | 41.95 ea. |
| 336969R  | 1968-72 Repro for Holley..... | 18.95 ea. |
| 3972679R | 1968-72 Repro for Q-Jet.....  | 18.95 ea. |
| AZC-88   | 1968-72 Cable Clip GM.....    | 6.95 ea.  |
| AXJ-CE   | Cable Decal.....              | 4.95 ea.  |

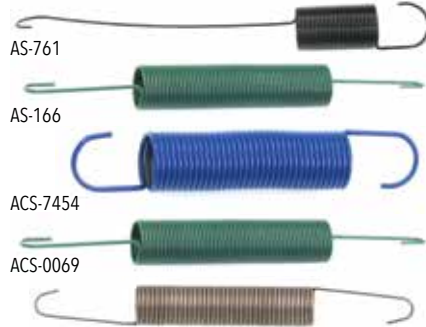

AS-761

AS-166

ACS-7454

ACS-0069

ATE-0068

**Carb Return Springs**

New correct color coded springs.

|          |                             |          |
|----------|-----------------------------|----------|
| AS-761   | 1965-67 BB.....             | 9.95 ea. |
| AS-166   | 1969 SB 4bbl.....           | 8.95 ea. |
| ACS-7454 | 1968-72 Holley L78 LS6..... | 9.95 ea. |
| ACS-0069 | 1968-69.....                | 8.95 ea. |
| ATE-0068 | 1969-72 Q-Jet.....          | 8.95 ea. |

**TCS Solenoid**

Correct TCS solenoids which mount to the carburetor stud. Includes correct brackets.

|         |                      |            |
|---------|----------------------|------------|
| 1114432 | 1970-71 350/400..... | 104.95 ea. |
| 1114434 | 1970 BB.....         | 104.95 ea. |

**INTAKE & RELATED**

**BUY'N SAVE**  
WITH KITS

CPX-9038



**PCV Hose & Filter Kit**

Complete with hose, filter and black pinch clamp. Pieces also available separately.

|          |                       |           |
|----------|-----------------------|-----------|
| CPX-9038 | 1967-72 Complete..... | 17.01 kit |
| CPH-9038 | Hose Only.....        | 11.95 ea. |
| CTC-1132 | Pinch Clamp Only..... | 0.50 ea.  |
| CAC-3800 | PCV Filter Only.....  | 5.95 ea.  |



3963569

**Intake Manifold**

This is a reproduction intake manifold with the correct W Snowflake for your Special High Performance engine!

|         |                                       |            |
|---------|---------------------------------------|------------|
| 3866963 | 1965 Z16 BB.....                      | 399.95 ea. |
| 3885069 | 1966-68 396/375 HP,427/450 HP.....    | 399.95 ea. |
| 3933198 | 1968-69 396-427SHP L88 ZL-1.....      | 399.95 ea. |
| 3933163 | 1969 BB Aluminum 396/375 HP.....      | 399.95 ea. |
| 3963569 | 1970 BB Low Rise LS6 / L78 / L89..... | 399.95 ea. |

No Volume Discount.



WND-8120WND

**Weiland Street Warrior Intake Manifolds**

The Weiland Street Warrior is designed for use on stock or stroker combinations that feature efficient cylinder heads. The latest advances in cam design necessitated the design of a new intake manifold, and the Weiland Street Warrior manifolds fill that void.

**Square Bore Carburetors**

|             |                                  |            |
|-------------|----------------------------------|------------|
| WND-8120WND | Small Block w/ 55-86 Heads.....  | 175.99 ea. |
| WND-8121    | Small Block w/ Vortec Heads..... | 219.99 ea. |

**Spread Bore Carburetors**

|          |                                 |            |
|----------|---------------------------------|------------|
| WND-8126 | Small Block w/ 87-95 Heads..... | 219.99 ea. |
|----------|---------------------------------|------------|

No Volume Discount.



WND-8150

**Weiland Speed Warrior Intake Manifolds**

The Weiland Speed Warrior features long, separated runners for bottom-end and mid-range power, plus a special runner design and larger plenum to flow the air needed for high-rpm horsepower. All of this usable power makes this intake perfect for your street and strip hot rod!

|             |                                 |            |
|-------------|---------------------------------|------------|
| WND-8150    | Small Block w/ 55-86 Heads..... | 187.99 ea. |
| WND-8170WND | Small Block w/ 87-95 Heads..... | 198.99 ea. |

No Volume Discount.



**BPS-3679** All 3/8" x 3/8" (Zinc)..... 6.99 ea.  
*(p.s. bracket, alternator mount, etc.)*  
**BPS-7432** All 5/16" x 3/8" (Black)..... 3.95 ea.  
*(TCS, P.B. tube, etc.)*



**Intake Manifold Vacuum Fittings**  
 Reproduction!! These high quality fittings for rear of intake manifold have correct "slip on" and threaded ends. These fittings have a variety of uses: power brake hose, auto transmission, air conditioning, cruise control, etc. Guaranteed to look, fit and function exactly as original.

**APN-0138** (1) Slip On Fitting..... 17.99 ea.  
**APN-0238** (2) Slip On Fittings..... 15.99 ea.  
**APN-0038** (1) Threaded Port..... 15.99 ea.  
**APN-638** (1) Threaded (1) Slip On..... 20.99 ea.  
**APN-738** (1) Threaded (2) Slip On..... 23.99 ea.  
**APN-838** (1) Threaded (3) Slip On..... 29.95 ea.



**Intake Manifold Bolts OEM**  
 Our OEM intake bolts feature correct size, coloring and head markings.

**BPI-4400** All SB "M" Flanged (12 pc.)..... 16.95 kit  
**BPI-9140** All BB "M" Cast Intake (16 pc.)..... 21.95 kit  
**BPI-2271** All BB "A" Aluminum Intake (16 pc.)..... 25.99 kit

**THERMOSTAT & RELATED**



**Thermostat**  
 High quality replacement thermostat.

**ACT-180** 180-85 Degrees..... 6.95 ea.  
**ACT-190** 190-95 Degrees..... 6.95 ea.

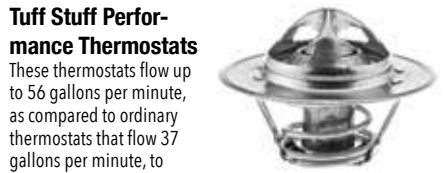

**Tuff Stuff Performance Thermostats**  
 These thermostats flow up to 56 gallons per minute, as compared to ordinary thermostats that flow 37 gallons per minute, to maintain stated temperature. The 50 percent increased coolant flow reduces the delay in engine warm-up times, allowing trapped air in the cooling system to escape and stabilize the pressure of the cooling system. The stainless steel construction with an extra-large center port assures increased coolant flow and bridge design increases strength, stability & reliability and incorporates a bypass valve that allows a small amount of coolant to circulate before fully opening, assuring a fast warm-up. Ideal for high performance muscle cars, street rods and customs.

**TUF-900160** 160 Degree..... 17.99 ea.  
**TUF-900180** 180 Degree..... 17.99 ea.  
**TUF-900195** 195 Degree..... 17.99 ea.  
*No Volume Discount.*



**Thermostat Housing**  
 Correct thermostat housing for high performance engines with aluminum intake manifolds. GM #3877660.

**ACI-7660** Aluminum..... 45.99 ea.



**L79 Thermostat Housing**  
 This is the correct goose-neck style thermostat housing for your L79 327/350 horsepower engine.

**ATE-7396** 1964-68..... 59.95 ea.



**Thermostat Housing**  
 Correct thermostat housing for cast iron manifolds. This was the most common housing and was found on most V8s.

**ABR-7660** Most V8..... 14.95 ea.  
**GCS-S9468** Most V8, 1/2" NPT Port..... 13.99 ea.

**Chrome Thermostat Housing**  
 Chrome steel thermostat housing with o-ring and bolts. Water neck points toward the driver side of the radiator.

**GCS-S9229** Most V8..... 12.99 kit



**Thermostat Housing Bolts**  
 Correct TR head marked bolts for attaching to intake.

**ATR-2039** 1964-68 SB..... 7.95 ea.  
**ATR-1039** 1969-77 SB..... 8.99 ea.  
**ATR-2039** 1964-72 BB..... 7.95 ea.



**Temp Sending Units**  
 Correct screw in sending units.

**GAC-250** 1964-72 w/o Gauges..... 16.95 ea.  
**GAC-560** 1964-72 w/ Gauges\*..... 16.95 ea.  
**GAC-760** 1969-70 w/ Gauges..... 32.95 ea.  
**GAC-660** 1970-72 TCS Sender\*\*..... 18.95 ea.  
*\*Can be used with CPX-999 harness. \*\* Correct 2 prong sending unit mounts on right side cylinder head.*

**WATER PUMP & RELATED**



**AC Delco Water Pumps**  
 Brand new AC Delco water pumps.

**ABR-0898** 1964-68 SB (Short Style)..... 63.95 ea.  
**ABR-0918** 1965-68 BB (Short Style)..... 119.99 ea.  
**ABR-1109** 1969-72 SB (Long Style)..... 65.95 ea.  
**ABR-1002** 1969-72 BB (Long Style)..... 89.99 ea.



**Water Pump OEM Attaching Bolt Kits**  
 Correct style attaching bolts with "TR" head markings.

**ATR-3232** 1964-68 2 Bolts 2 Stud..... 8.99 kit  
**ATR-4334** 1969-72 All 4 Bolts M Mark..... 10.99 kit  
**AWS-3015** Stud Only (Short)..... 2.99 ea.



## Tuff Stuff Water Pumps

Tuff Stuff water pumps are available in multiple different finishes. Available in standard flow or high flow (Super Cool) version for high power applications. Also available in "Smoothie" version, which features flat top casting with no top water port or plug.

### Small Block

|             |  |            |
|-------------|--|------------|
| TUF-1354NA  | 1964-68 Short Style, Chrome .....                  | 109.99 ea. |
| TUF-1354N   | 1964-68 Short Style, SC, Cast Finish .....         | 76.99 ea.  |
| TUF-1354NC  | 1964-68 Short Style, SC, Black .....               | 88.99 ea.  |
| TUF-1354NB  | 1964-68 Short Style, SC, Chrome .....              | 117.99 ea. |
| TUF-1354NAS | 1964-68 Short Style, Smoothie, Chrome .....        | 115.99 ea. |
| TUF-1449NA  | 1969+ Long Style, Chrome .....                     | 139.99 ea. |
| TUF-1511NC  | 1969+ Long Style, Platinum, Cast Finish .....      | 158.99 ea. |
| TUF-1449N   | 1969+ Long Style, SC, Cast Finish .....            | 76.99 ea.  |
| TUF-1449NC  | 1969+ Long Style, SC, Black .....                  | 88.99 ea.  |
| TUF-1449NB  | 1969+ Long Style, SC, Chrome .....                 | 156.99 ea. |
| TUF-1448NC  | 1969+ Long Style, SC, Smoothie, Cast Finish .....  | 121.99 ea. |
| TUF-1448NB  | 1969+ Long Style, SC, Smoothie, Polished Alum..... | 156.99 ea. |
| TUF-1353NA7 | 1964-68 Short Style Smoothie Black Chrome .....    | 185.99 ea. |
| TUF-1448NA7 | 1969-77 Long Style Smoothie Black Chrome.....      | 194.99 ea. |

### Big Block

|             |   |            |
|-------------|---|------------|
| TUF-1494N   | 1964-68 Short Style, Cast Finish .....              | 82.99 ea.  |
| TUF-1494NC  | 1964-68 Short Style, SC, Black .....                | 105.99 ea. |
| TUF-1494NA  | 1964-68 Short Style, SC, Chrome.....                | 139.99 ea. |
| TUF-1461NA  | 1969+ Long Style, Chrome .....                      | 164.99 ea. |
| TUF-1461N   | 1969+ Long Style, SC, Cast Finish .....             | 93.99 ea.  |
| TUF-1461NC  | 1969+ Long Style, SC, Black.....                    | 112.99 ea. |
| TUF-1496NA7 | 1964-68 Short Style Smoothie Black Chrome .....     | 251.99 ea. |
| TUF-1495NA7 | 1964-68 Short Style, SC, Smoothie Black Chrome..... | 325.99 ea. |
| TUF-1459NA7 | 1969-77 Long Style Smoothie Black Chrome .....      | 229.99 ea. |

No Volume Discount.

## Tuff Stuff Water Pump Bolt Kits

Chrome plated hex head bolts. Includes 4 bolts, 4 flat washers and 4 lock washers.

|           |                           |           |
|-----------|---------------------------|-----------|
| TUF-7675A | All SB, Short Style ..... | 18.99 ea. |
| TUF-7676A | All BB, Short Style ..... | 18.99 ea. |



TUF-1354NA

TUF-4450A



## Tuff Stuff Chrome Heater Hose/Bypass Nipples

Chrome plated heater hose/bypass hose fittings.

|           |                 |          |
|-----------|-----------------|----------|
| TUF-4450A | 3/4" Long ..... | 8.95 ea. |
| TUF-4450B | 3/4" Short..... | 8.95 ea. |
| TUF-4450C | 5/8" Short..... | 8.95 ea. |



TUF-7675A

CPH-1658



CPH-1672



## Water Pump Bypass Hose Kits

Correct OEM GM marked bypass hose with correct clamps.

|          |                             |           |
|----------|-----------------------------|-----------|
| CPH-1658 | 1964-67 SB w/ SHP .....     | 12.95 kit |
| CPH-1658 | 1965-68 BB (Molded).....    | 12.95 kit |
| CPH-1672 | 1969-72 BB (Ribbed).....    | 9.95 kit  |
| CPB-034  | 1965-72 BB Clamp (NOS)..... | 4.95 ea.  |

AWP-1394



AWP-949



## Water Pump Pulley

Reproduction original water pump pulleys.

|          |                                 |           |
|----------|---------------------------------|-----------|
| AWP-796  | 1969+ All V8 (1 Groove).....    | 29.95 ea. |
| AWP-9950 | 1965-68 All BB (1 Groove).....  | 42.95 ea. |
| AWP-656  | 1965-68 BB (2 Groove Deep)..... | 99.95 ea. |
| AWP-1394 | 1969+ BB (1 Groove Deep).....   | 47.99 ea. |
| AWP-949  | 1969+ All (2 Groove w/ AC)..... | 99.99 ea. |
| AWP-6060 | 1970-72 LS6 Deep .....          | 69.95 ea. |



AWW-65

## Short Water Pump Washer

This washer is for any Chevrolet engine with a short water pump. Since this part can't be seen when the pulley is installed, most people are unaware it exists, but it provides important support for the pulley.

|        |                   |          |
|--------|-------------------|----------|
| AWW-65 | 1964-68 All ..... | 5.99 ea. |
|--------|-------------------|----------|

\*Works on all cars with short water pump.

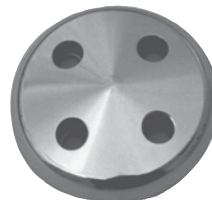

GCS-S9488

## Water Pump Pulley Nose

Finish off your pulley set in style with this show quality nose. Bolts to the front of your water pump pulley when using electric fans.

|              |                     |           |
|--------------|---------------------|-----------|
| GCS-S9488    | SWP, Satin .....    | 16.99 ea. |
| GCS-S9488POL | SWP, Polished.....  | 17.99 ea. |
| GCS-S9489    | LWP, Satin.....     | 14.99 ea. |
| GCS-S9489POL | LWP, Polished ..... | 20.99 ea. |

Note: SWP = Short Water Pump. LWP = Long Water Pump.

GCS-S9478

GCS-S0005

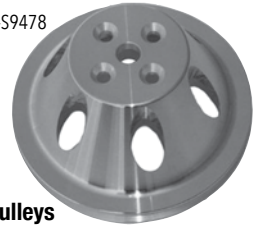

## Billet Water Pump Pulleys

These show quality billet aluminum water pump pulleys will set your show car apart from the crowd. Made of high quality aircraft aluminum.

|              |                                   |           |
|--------------|-----------------------------------|-----------|
| GCS-S9478    | SB, SWP, 1 Groove, Satin .....    | 38.99 ea. |
| GCS-S9478POL | SB, SWP, 1 Groove, Polished ..... | 41.99 ea. |
| GCS-S9600    | SB, SWP, 1 Groove, Chrome .....   | 20.99 ea. |
| GCS-S9479    | SB, SWP, 2 Groove, Satin .....    | 52.99 ea. |
| GCS-S9479POL | SB, SWP, 2 Groove, Polished ..... | 52.99 ea. |
| GCS-S9601    | SB, SWP, 2 Groove, Chrome .....   | 20.99 ea. |
| GCS-S9482    | SB, LWP, 1 Groove, Satin.....     | 35.99 ea. |
| GCS-S9482POL | SB, LWP, 1 Groove, Polished ..... | 41.99 ea. |
| GCS-S9604    | SB, LWP, 1 Groove, Chrome .....   | 20.99 ea. |
| GCS-S9483    | SB, LWP, 2 Groove, Satin.....     | 52.99 ea. |
| GCS-S9483POL | SB, LWP, 2 Groove, Polished.....  | 62.99 ea. |
| GCS-S9605    | SB, LWP, 2 Groove, Chrome .....   | 20.99 ea. |
| GCS-S8840    | BB, SWP, 1 Groove, Satin.....     | 41.99 ea. |
| GCS-S8840POL | BB, SWP, 1 Groove, Polished ..... | 41.99 ea. |
| GCS-S8842    | BB, SWP, 2 Groove, Satin .....    | 52.99 ea. |
| GCS-S8842POL | BB, SWP, 2 Groove, Polished ..... | 57.99 ea. |
| GCS-S9815    | BB, SWP, 2 Groove, Chrome .....   | 31.99 ea. |
| GCS-S8844    | BB, LWP, 2 Groove, Satin .....    | 52.99 ea. |
| GCS-S8844POL | BB, LWP, 2 Groove, Polished.....  | 41.99 ea. |
| GCS-S9723    | BB, LWP, 2 Groove, Chrome.....    | 25.99 ea. |
| GCS-S0005    | Tapered Seat Bolts.....           | 4.99 ea.  |

Note: SWP = Short Water Pump. LWP = Long Water Pump.

**PULLEYS**



**Crank Pulleys**

All pulleys are original GM or the highest quality reproductions on the market. Each pulley is finished in factory matte black like the originals.

|          |   |            |
|----------|---|------------|
| ACP-904  | 1964-67 327/350 1 Groove SWP .....        | 39.95 ea.  |
| ACP-833  | 1966-67 L-79 2 Groove Deep SWP .....      | 52.95 ea.  |
| ACP-414  | 1969-72 SB 3 Groove LWP .....             | 69.99 ea.  |
| NQ-457   | 1969-72 350 2 Groove Deep LWP .....       | 79.99 ea.  |
| ACP-203  | 1964-68 396 1 Groove* SWP** .....         | 45.95 ea.  |
| ACP-108  | 1965-68 396/375 2 Groove Deep** SWP... .. | 55.95 ea.  |
| ACP-333  | 1965-68 396/375 3 Grv Deep Cast SWP... .. | 199.95 ea. |
| AHQ-1396 | 1969-72 396 2 Groove Deep LWP .....       | 89.99 ea.  |
| ACP-330  | 1969-72 396/454 3 Groove w/ AC LWP .....  | 74.95 ea.  |
| ACP-404  | 1969-72 SB 2 Groove LWP .....             | 69.95 ea.  |

\*Without Power Steering.

\*\*For all with power steering use with ADP-61.



BFC-333

**Crank Pulley OEM Attaching Bolt Kit**

|         |                            |          |
|---------|----------------------------|----------|
| BFC-333 | All w/ Fine Thread .....   | 6.95 kit |
| BRB-100 | All w/ Coarse Thread ..... | 6.95 kit |

**HARMONIC BALANCER**



BPB-5933

BPB-5934

**Harmonic Balancer Attaching Bolt-Washer**

|          |                       |           |
|----------|-----------------------|-----------|
| BPB-5933 | 1964-72 Most SB ..... | 14.99 kit |
| BPB-5934 | 1965-72 All BB .....  | 13.99 kit |

**STARTERS & RELATED**



ASM-10A

ASM-20M

**Starter Motor**

We carry original AC Delco USA re-manufactured starter motors complete with warranty. No core charge.

|         |                         |            |
|---------|-------------------------|------------|
| ASM-10A | 1964-72 SB Auto .....   | 113.99 ea. |
| ASM-10M | 1964-72 SB Manual ..... | 113.95 ea. |
| ASM-20A | 1965-72 BB Auto .....   | 102.95 ea. |
| ASM-20M | 1965-72 BB Manual ..... | 102.99 ea. |

No Volume Discount.



TUF-6550B

**Tuff Stuff Gear Reduction Starters**

These gear reduction starters will allow you to easily crank over your high performance engine. They use less draw than traditional replacement starters and gear reduction allows them to crank over engines with higher compression. These starters will work on both Small Block Chevy and Big Block Chevy Engines using 153 or 168 tooth flywheels. Please be sure to check your flywheel tooth count before ordering.

|            |  |            |
|------------|--|------------|
| TUF-6550B  | 1.6 H.P., 11:1 Compression, White Zinc ..... | 143.99 ea. |
| TUF-6550A  | 1.6 H.P., 11:1 Compression, Chrome .....     | 183.99 ea. |
| TUF-6584B  | 1.9 H.P., 12:1 Compression, Black .....      | 139.99 ea. |
| TUF-6772B  | 2.6 H.P., 18:1 Compression, Black .....      | 177.99 ea. |
| TUF-3193NB | 3 H.P., 18:1 Compression, White Zinc .....   | 175.99 ea. |
| TUF-3510A  | 1.9 H.P., 18:1 Compression, Chrome* .....    | 167.99 ea. |
| TUF-3510B  | 1.9 H.P., 18:1 Compression, Black* .....     | 124.99 ea. |

\*Offset mounting bolts, 168 tooth flywheel only.

**Tuff Stuff Hot Start Remote Solenoid Kit**  
Give your starter an extra 12 V boost with these hot start kits from Tuff Stuff! This kit is designed to eliminate hot start problems that are common with starter-mounted solenoids. Ideal for GM full-size OEM starters.

|          |                   |           |
|----------|-------------------|-----------|
| TUF-7629 | 1964-77 All ..... | 23.99 kit |
|----------|-------------------|-----------|

No Volume Discount.



**Starter Motor Bolts OEM**

Correct "Knurled" bolts for attaching starter motor to block.

|         |                                  |          |
|---------|----------------------------------|----------|
| BV-2070 | SB 3/8-16 x 1 7/8" (Short) ..... | 5.99 ea. |
| BV-2072 | BB 3/8-16 x 3 5/8" (Long) .....  | 4.99 ea. |
| BV-2074 | 3/8-16 x 4 11/16" (X-Long) ..... | 6.99 ea. |



**Starter Heat Shield**

Correct starter heat shield for most BB.

|          |              |           |
|----------|--------------|-----------|
| APX-1443 | All BB ..... | 34.95 ea. |
|----------|--------------|-----------|

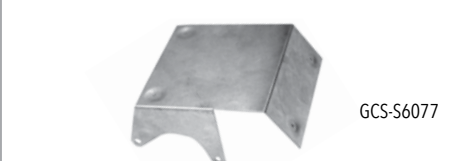

**Satin Finish Starter Heat Shield**

Protect your starter in style with this satin aluminum starter heat shield.

|           |             |           |
|-----------|-------------|-----------|
| GCS-S6077 | Satin ..... | 17.99 ea. |
|-----------|-------------|-----------|

Note: May require some custom fitting. May not clear larger starters.

**STARTERS & RELATED**



ATE-4353



ABB-9655

**Starter Motor Brace**

Correct brace for attaching starter to block.

|          |                         |           |
|----------|-------------------------|-----------|
| ATE-4353 | 1964-72 SB w/o 350..... | 11.95 ea. |
| ATW-2516 | 1964-72 SB 350.....     | 8.95 ea.  |
| ABB-9655 | 1964-72 All BB.....     | 12.99 ea. |
| APO-516  | Attaching Screw.....    | 0.50 ea.  |

**ALTERNATOR**



ABB-5790



ABN-105

**Alternator Pulleys**

|          |                                  |           |
|----------|----------------------------------|-----------|
| ABB-5790 | Standard (2-3/4" OD).....        | 20.99 ea. |
| ABB-5790 | All w/ SHP (3-1/4" OD) Deep..... | 39.95 ea. |
| ABN-105  | Correct Retaining Nut.....       | 3.99 ea.  |



APX-1724



APX-2559



AVC-1144

**Alternator Accessories**

|          |                           |           |
|----------|---------------------------|-----------|
| APX-1724 | All Fan w/ Nut.....       | 15.95 kit |
| AVC-1144 | 1967-81 All Pigtail.....  | 4.95 ea.  |
| APX-2559 | Rear Alternator Boot..... | 4.95 ea.  |



BN-339

|         |                                |           |
|---------|--------------------------------|-----------|
| BN-339  | 1969-72 BB Lower Stud/Nut..... | 10.99 ea. |
| BZ-117  | 1965-68 BB Hardware Kit.....   | 15.99 kit |
| BRB-938 | 1969-72 SB Lower Bolt.....     | 4.95 ea.  |

**Alternator Hardware**

All of the correct hardware needed to mount your alternator!



APX-1138

|          |                              |           |
|----------|------------------------------|-----------|
| APX-1138 | 1969-72 SB Spacer Brace..... | 17.99 ea. |
|----------|------------------------------|-----------|



APX-1038

|          |                              |           |
|----------|------------------------------|-----------|
| APX-1038 | 1969-72 BB Spacer/Brace..... | 15.95 ea. |
|----------|------------------------------|-----------|



AWB-1114

|          |  |          |
|----------|--|----------|
| AWB-1114 | 1964-72 Upper Adjustment Kit<br>w/ W Bolt..... | 5.99 kit |
|----------|--|----------|



AW-506

|        |  |          |
|--------|--|----------|
| AW-506 | 1964-72 Neg Cable Ground<br>Bolt/Washer..... | 0.95 ea. |
|--------|--|----------|



ABC-23

|        |                                    |           |
|--------|------------------------------------|-----------|
| ABC-23 | 1969-72 Battery Cable Clip SB..... | 13.95 ea. |
|--------|------------------------------------|-----------|

*For top of alternator*



ATE-5416

|          |                                   |          |
|----------|-----------------------------------|----------|
| ATE-5416 | 1969-72 Heater Hose Retainer..... | 6.99 ea. |
|----------|-----------------------------------|----------|

*For top of alternator*



**Tuff Stuff Internally Regulated Alternators**

Designed to handle the demand for power needed for today's electronics, Tuff Stuff's high powered internally regulated alternators are perfect if you have added a set of high powered headlights or a high powered stereo system or any other electronic systems to your Chevelle. Although meant for 1971 and newer internally regulated set ups, they can be used on older models that have been converted from external to internally regulated.

|                  |   |            |
|------------------|---|------------|
| TUF-7127NB       | 80 Amp, 1 Wire, Chrome.....                                       | 126.99 ea. |
| TUF-7127D        | 100 Amp, 1 Wire, Cast Finish.....                                 | 92.99 ea.  |
| TUF-7127NF       | 100 Amp, 1 Wire, Black.....                                       | 126.99 ea. |
| TUF-7127ND       | 100 Amp, 1 Wire, Chrome.....                                      | 126.99 ea. |
| TUF-7127NDP      | 100 Amp, 1 Wire, Polished Aluminum.....                           | 126.99 ea. |
| TUF-7127K        | 140 Amp, 1 Wire, Cast Finish.....                                 | 131.99 ea. |
| TUF-7127NK       | 140 Amp, 1 Wire, Chrome.....                                      | 145.99 ea. |
| TUF-7139ABULL    | 100 Amp, Silver Bullet, 1 Wire, Chrome.....                       | 163.99 ea. |
| TUF-7140FBULL    | 140 Amp, Silver Bullet, 1 Wire, Black.....                        | 180.99 ea. |
| TUF-7140ABULL    | 140 Amp, Silver Bullet, 1 Wire, Chrome.....                       | 219.99 ea. |
| TUF-7127ND7      | 100 Amp 1 Wire Black Chrome V-Belt.....                           | 148.99 ea. |
| TUF-7127ND6G7    | 100 Amp 1 Wire Black Chrome<br>Serpentine Belt.....               | 148.99 ea. |
| TUF-7139ABULL7   | 100 Amp Silver Bullet 1 Wire Black<br>Chrome V-Belt.....          | 191.99 ea. |
| TUF-7139ABULL6G7 | 100 Amp Silver Bullet 1 Wire Black<br>Chrome Serpentine Belt..... | 193.99 ea. |
| TUF-7127NK7      | 140 Amp 1 Wire Black Chrome V-Belt.....                           | 170.99 ea. |
| TUF-7127NK6G7    | 140 Amp 1 Wire Black Chrome<br>Serpentine Belt.....               | 171.99 ea. |
| TUF-7140ABULL7   | 140 Amp Silver Bullet 1 Wire Black<br>Chrome V-Belt.....          | 257.99 ea. |
| TUF-7140ABULL6G7 | 140 Amp Silver Bullet 1 Wire Black<br>Chrome Serpentine Belt..... | 260.99 ea. |

**Tuff Stuff Alternator Accessories**

|           |   |           |
|-----------|---|-----------|
| TUF-7500A | Chrome Alternator Case Kit.....               | 65.99 kit |
| TUF-7600A | Chrome Fan and Pulley Kit, Single Groove ..   | 23.99 kit |
| TUF-7600B | Chrome Fan and Pulley Kit, Double Groove..... | 26.99 kit |
| TUF-7610E | Chrome Alternator Pulley, Single Groove.....  | 17.99 ea. |



TUF-7102



TUF-7102NF



TUF-7102NA

**Tuff Stuff Externally Regulated Alternators**

All Tuff Stuff alternators are hand built-in Cleveland, Ohio and are tested to meet or exceed OEM specifications. All Tuff Stuff alternators are made from 100% new components and carry a one year limited warranty. All alternators are for 12 volt, negative ground systems, except where noted.

|              |  |            |
|--------------|--|------------|
| TUF-7102     | 80 Amp Cast Aluminum V-Belt .....      | 92.99 ea.  |
| TUF-7102NA   | 80 Amp Chrome V-Belt .....             | 127.99 ea. |
| TUF-7102NAP  | 80 Amp Polished Aluminum V-Belt .....  | 127.99 ea. |
| TUF-7102NF   | 80 Amp Black V-Belt .....              | 122.99 ea. |
| TUF-7102NC   | 100 Amp Chrome V-Belt .....            | 127.99 ea. |
| TUF-7102NCP  | 100 Amp Polished Aluminum V-Belt ..... | 127.99 ea. |
| TUF-7102NE   | 100 Amp Black V-Belt .....             | 122.99 ea. |
| TUF-7102NFBW | 100 Amp Black Wrinkle V-Belt .....     | 126.99 ea. |
| TUF-7102NKBW | 140 Amp Black Wrinkle V-Belt .....     | 152.99 ea. |

No Volume Discount.

**NO CORE CHARGE**



AIT-6961

**Alternators**

Rebuilt alternator made in the USA. Each alternator is 100% tested and rebuilt to exceed OEM specs.

|          |                           |           |
|----------|---------------------------|-----------|
| AIT-6961 | 41 Amp External Reg ..... | 79.95 ea. |
| AIT-6963 | 55 Amp External Reg ..... | 89.95 ea. |
| AIT-3342 | 63 Amp Internal Reg ..... | 84.99 ea. |

No Volume Discount.



TUF-7520A



TUF-7520B

**Tuff Stuff Alternator Pigtails**

Replace worn or broken alternator connectors with Tuff Stuff's replacement pigtails to eliminate any electrical issues. These will fit factory alternators.

|           |                                 |           |
|-----------|---------------------------------|-----------|
| TUF-7520B | Externally Regulated 10DN ..... | 10.99 ea. |
| TUF-7520A | Internally Regulated 10SI ..... | 7.99 ea.  |



GCS-S6679

**Alternator Dress Up Kit**

This kit is designed to take your stock internally regulated alternator and make it show ready. This kit includes a chrome alternator case, pulley, fan and hardware.

|           |                  |           |
|-----------|------------------|-----------|
| GCS-S6679 | 1973-85 GM ..... | 43.99 kit |
|-----------|------------------|-----------|

Note: For 1973-85 internal regulated alternators only.



GCS-S9487

**Billet Alternator Pulleys**

Show quality billet alternator pulleys.

|              |                          |           |
|--------------|--------------------------|-----------|
| GCS-S9487    | 1 Groove, Satin .....    | 25.99 ea. |
| GCS-S9487POL | 1 Groove, Polished ..... | 31.99 ea. |
| GCS-S9447    | 2 Groove, Chrome .....   | 17.99 ea. |



GCS-S8867

**Billet Alternator Fan**

Polished billet aluminum.

|           |                |           |
|-----------|----------------|-----------|
| GCS-S8867 | Polished ..... | 12.99 ea. |
|-----------|----------------|-----------|



GCS-S9446

**Chrome Alternator Fan w/ Pulley**

Chrome plated steel OEM style alternator fan with chrome single groove pulley. Includes nut.

|           |              |           |
|-----------|--------------|-----------|
| GCS-S9446 | Chrome ..... | 15.99 kit |
|-----------|--------------|-----------|



APX-ALT-CAP

**Alternator Positive Terminal Cap Red**

This is a new reproduction red plastic GM style alternator positive terminal cap and retainer kit. Check alternator to cylinder head clearance before ordering. Some applications are tight.

|             |               |           |
|-------------|---------------|-----------|
| APX-ALT-CAP | 1964-77 ..... | 13.95 set |
|-------------|---------------|-----------|

**Small Block Alternator Brackets**

OE style reproduction alternator brackets for your small block Chevy.

AAB-65L



AAB-65L 1964-68 SB Lower..... 17.95 ea.  
\*Use with AAB-64L if you have headers.



ACE-5333

ACE-5333 1969-72 SB Lower..... 16.99 ea.

AAB-3400



AAB-3400 1964-68 SB Upper..... 29.95 ea.

AAB-64L

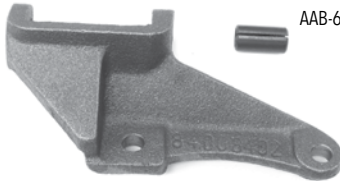

AAB-64L 1964-68 SB Lower..... 39.95 ea.  
For exhaust manifolds.

ACE-2956



ACE-2956 1969-72 SB Upper..... 29.99 ea.

**Big Block Alternator Brackets**

OE style reproduction alternator brackets for your big block Chevy.

AAB-4500



AAB-4500 1965-68 BB Upper..... 19.95 ea.

ARZ-0027



ARZ-0027 1965-68 BB Lower ..... 46.95 ea.

AK-173



AK-173 1969-72 BB Upper..... 36.95 ea.

AK-175



AK-175 1969-72 BB Lower ..... 29.95 ea.

AR-0180



**1965-68 SHP Alternator Bracket Kit**  
Correct upper and lower bracket stamped "GT" for all 1965-68 SB.  
AR-0180 1965-68 SHP ..... 79.95 kit

**BUY'N SAVE**  
WITH KITS



**1965-68 Big Block Alternator Bracket Kit**

This is a complete set of alternator brackets and hardware for your 1965-68 Chevelle big block with short water pump. This kit works on all cars with short water pumps.

AA-45KIT 1965-68 BB Short Pump..... 79.99 kit



**1969-72 Big Block Alternator Mounting Kit**

Reproduction of upper-lower brackets, lower mounting stud, lower spacer-brace and upper adjustment bolt w/ special washer.

AKK-301 1969-72 All BB..... 69.99 kit



**1970-73 Big Block Alternator Mounting Kit**









This kit comes with the upper alternator bracket featuring the correct 70+ hole, lower alternator bracket, lower mounting stud, lower spacer brace, upper adjustment bolt, and special washer for your 1970-1973 Chevelle big block.

AKK-305 1970-73 All BB..... 69.99 kit

**OE Style Chrome Alternator Brackets**

These high quality brackets will give your show car that finishing touch!









|   |                                     |   |                                    |   |                                     |
|---|-------------------------------------|---|------------------------------------|---|-------------------------------------|
|  | GCS-S9315                           |  | GCS-S9637                          |  | GCS-S9318                           |
| GCS-S9315   | SB Upper SWP..... 14.99 ea.         | GCS-S9637   | SB Lower LWP (69-75)..... 6.99 ea. | GCS-S9318   | BB Upper LWP (69-92)..... 14.99 ea. |
|  | GCS-S9316                           |  | GCS-S9502                          |  | GCS-S9638                           |
| GCS-S9316   | SB Upper LWP (69-75)..... 14.99 ea. | GCS-S9502   | BB Lower SWP ..... 34.99 ea.       | GCS-S9638   | BB Lower LWP (69-92)..... 6.99 ea.  |
|  | GCS-S9317                           |  | GCS-S9581                          |  | GCS-S9254                           |
| GCS-S9317   | SB Upper LWP (76-86)..... 15.99 ea. | GCS-S9581   | BB Upper SWP ..... 14.99 ea.       | GCS-S9254   | Bracket for Headers..... 12.99 ea.  |

Note: SWP = Short Water Pump. LWP = Long Water Pump.

**Custom Style Alternator Brackets**

These chrome plated steel alternator brackets will give your engine a unique custom look that will stand out from the crowd.

|   |                                     |   |                                     |   |                                     |
|---|-------------------------------------|---|-------------------------------------|---|-------------------------------------|
|  | GCS-S9319                           |     | GCS-S9320                           |    | GCS-S1637                           |
| GCS-S9319   | SB Upper SWP..... 14.99 ea.         | GCS-S9320   | V8 Upper LWP (69-75)..... 12.99 ea. | GCS-S1637   | SB Upper LWP (76-86)..... 17.99 ea. |
|  | GCS-S9321                           |  | GCS-S1647                           |  | GCS-S1647                           |
| GCS-S9321   | SB Upper LWP (76-86)..... 12.99 ea. | GCS-S1647   | BB Upper LWP (69-92)..... 17.99 ea. |   |                                     |

**TIMING**



AJ-408

**Timing Covers**

New covers complete with crankshaft seal.

|         |  |
|---------|--|
| AJ-408  | 1968-76 All Small Block..... 48.95 ea. |
| AJ-850  | 1965-72 All Big Block ..... 46.95 ea.  |
| BTC-650 | Correct Attaching Bolts..... 8.95 kit  |

GCS-S4935



**Chrome Timing Covers**

Brilliantly polished timing cover with a rigid sealing surface.

|            |  |
|------------|--|
| GCS-S4932  | SB SWP Chrome..... 22.99 ea.           |
| GCS-S4934  | SB LWP Chrome..... 23.99 ea.           |
| GCS-S4935  | BB All Chrome..... 23.99 ea.           |
| GCS-S4935R | BB All Unfinished Steel..... 23.99 ea. |

Note: These covers may not work with some double roller timing chains. Check clearance before starting engine. Doubling of the gaskets or shims may be required to use cover with a short water pump. SWP = Short water pump. LWP = Long water pump.

GCS-S6040C



**2 Piece Aluminum Timing Covers**

An excellent upgrade for your engine. Rigid sealing surface for positive seal and it looks great, too!

|            |                                   |
|------------|-----------------------------------|
| GCS-S6040  | SB Polished Billet..... 20.99 ea. |
| GCS-S6040C | SB Chrome Billet..... 47.99 ea.   |
| GCS-S8422  | BB Polished Billet..... 41.99 ea. |
| GCS-S8422C | BB Chrome Billet..... 62.99 ea.   |

Note: These covers may not work with some double roller timing chains. Check clearance before starting engine. Doubling of the gaskets or shims may be required to use cover with a short water pump.

**TIMING**



ATP-07

**Timing Cover Pointers**

Correct pointer for adjustment of engine timing.

|        |                          |           |
|--------|--------------------------|-----------|
| ATP-07 | 1965-68 SB               | 7.99 ea.  |
| ATP-36 | 1969-72 SB               | 10.99 ea. |
| ATP-47 | 1965-72 SB w/ 7" Bal     | 19.99 ea. |
| ATP-07 | 1965-72 BB SHP w/ 8" Bal | 7.99 ea.  |



GCS-S4961

**Chrome Adjustable Timing Pointers**

Provides a convenient way to adjust and verify your engine's ignition timing. Finished brilliant chrome plated steel.

|           |                  |          |
|-----------|------------------|----------|
| GCS-S9178 | SB 7"            | 7.99 ea. |
| GCS-S9179 | SB 8"            | 7.99 ea. |
| GCS-S4961 | BB 8"            | 3.99 ea. |
| GCS-S9180 | BB 8" Adjustable | 4.99 ea. |



GCS-S6041

GCS-S6042C

**SB Billet Timing Cover Pointer**

Provides a convenient way to adjust and verify your engine's ignition timing. Adjustable and can be used with 6" or 7" balancers.

|            |                      |           |
|------------|----------------------|-----------|
| GCS-S6041C | Chrome Plated Billet | 26.99 ea. |
| GCS-S6042  | Ball Milled          | 28.99 ea. |
| GCS-S6042C | Ball Milled Chrome   | 28.99 ea. |
| GCS-S4960  | Chrome Plated Steel  | 4.99 ea.  |
| GCS-S6041  | Billet               | 24.99 ea. |



GCS-S2083

**Chrome Holley Carburetor Throttle Return Kit**

Designed to make mounting the spring a snap! Works on most Holley carburetor applications.

|           |        |           |
|-----------|--------|-----------|
| GCS-S2083 | Holley | 14.99 kit |
|-----------|--------|-----------|

Note: Due to the universal nature of this part, fitting and/or modifications may be required.

**DISTRIBUTOR**



ACE-1400

**Distributor Hold Down**

Correct retaining hardware for distributors

|          |        |          |
|----------|--------|----------|
| ACE-1400 | All V8 | 4.95 kit |
|----------|--------|----------|



GCS-S5116

**Custom Distributor Hold Down Kit**

Designed to secure your distributor settings and look good doing it. Choose from chrome or billet.

|           |        |           |
|-----------|--------|-----------|
| GCS-S4116 | Chrome | 4.99 ea.  |
| GCS-S5116 | Billet | 17.99 ea. |



GRC-12835

**Radio Capacitor**

Came from the factory on all cars with radio. Correct length lead wire & brass connector. Stamped 1964452 "DR" & ".3MF" as original.

|           |         |           |
|-----------|---------|-----------|
| GRC-12834 | 1964-71 | 29.99 ea. |
| GRC-12835 | 1970-74 | 29.99 ea. |



N-2441

**Tune Up Kit**

Tune up kit with new points, condenser and rotor.

|        |             |           |
|--------|-------------|-----------|
| N-2441 | 1964-73 All | 45.95 ea. |
|--------|-------------|-----------|



ALI-65



ALI-3119



BAN-516

**Coil Bracket**

Reproduction of original comes with retaining screw.

|          |                    |           |
|----------|--------------------|-----------|
| ALI-65   | 1965 L79           | 99.95 ea. |
| ALI-3119 | All V8             | 19.99 ea. |
| BAN-516  | Correct SEMS Bolts | 1.95 pr.  |



ALI-1504

A-193

**Starter Solenoid Wire Clip**

Correct clip for retaining wire harness to solenoid.

|          |                |           |
|----------|----------------|-----------|
| ALI-1504 | 1964-67 All V8 | 17.99 ea. |
| A-193    | 1968-72 All V8 | 24.95 ea. |



GCS-S9366

**Chrome Ignition Coil Bracket**

This brightly chrome plated ignition coil bracket will look great in your engine compartment. Fits most round cylinder style ignition coils.

|           |              |          |
|-----------|--------------|----------|
| GCS-S9366 | Coil Bracket | 7.99 ea. |
|-----------|--------------|----------|



GCS-S3112

**HEI Distributor Pigtail**

|           |     |           |
|-----------|-----|-----------|
| GCS-S3112 | All | 11.99 ea. |
|-----------|-----|-----------|



A2525



1971244



GM Restoration Parts

**Distributor Cap**

Choose from AC Delco replacement distributor cap or reproduction distributor cap with GM numbers. Red cap features heavy duty brass terminals for high performance engines.

|         |             |           |
|---------|-------------|-----------|
| A2525   | Red Cap     | 79.95 ea. |
| 1971244 | Black Cap   | 69.95 ea. |
| AA3-308 | Replacement | 22.95 ea. |

**DISTRIBUTOR** *continued*



ADS-2100-SC-CLEAR



ADS-2100-SC-RED

**HEI Distributor**

Chrome aluminum HEI electronic distributor w/ built-in 50K coil.

|                   |                         |       |            |
|-------------------|-------------------------|-------|------------|
| ADS-2100          | All V8                  | ..... | 72.99 ea.  |
| ADS-2100-SC-RED   | All V8, Red Super Cap   | ..... | 102.99 ea. |
| ADS-2100-SC-CLEAR | All V8, Clear Super Cap | ..... | 108.99 ea. |
| GCS-S3938-BLUE    | 16 Blue Super Cap*      | ..... | 67.99 ea.  |

\*For 292 Inline 6 cyl. only.



ACCEL-59107

**Accel Replacement HEI Distributor**

Using all new components, these distributors feature: High performance ACCEL Electronics. All new components-housing castings, ce. Direct plug-in replacement with factory type connector. Fits standard deck height small and big block engines. Coil Not Included!

|             |            |       |            |
|-------------|------------|-------|------------|
| ACCEL-59107 | All w/ HEI | ..... | 147.99 ea. |
|-------------|------------|-------|------------|

No Volume Discount.



MSD-8362

**MSD HEI Distributor**

For value conscious enthusiasts, the Street Fire HEI is a great choice! We know the importance of a centrifugal advance in a distributor so our engineers made sure that the Street Fire received an advance assembly with coated weights and welded weight pins (not just pressed in like other models). Another area that you cannot afford to scrimp on is with a distributor gear. The Street Fire is fit with the same gear that is used on our Pro-Billet models. The metallurgy of this gear has been refined for years to perform through the harshest conditions.

|          |                            |       |            |
|----------|----------------------------|-------|------------|
| MSD-8362 | All, Red Cap 4 Pin*        | ..... | 177.99 ea. |
| MSD-8365 | All Billet, Red Cap 4 Pin* | ..... | 471.99 ea. |

Note: Standard deck height blocks only. Will not fit gen 5 and 6 big blocks. \*Refers to the amount of terminals on the ignition module. No Volume Discount.



MSD-8360



**MSD Pro Billet Distributor**

The Pro-Billet Ready-to-Run distributor is the perfect upgrade for outdated points distributors or bulky HEIs. Simply install the distributor in the engine, connect three wires, the coil and fire it up!

|           |            |       |            |
|-----------|------------|-------|------------|
| MSD-8360  | Chevy V8*  | ..... | 381.99 ea. |
| MSD-85551 | Chevy V8** | ..... | 296.99 ea. |

\*Does not have nor can accept a vacuum advance canister.

\*\*Must be used with a MSD 6, 7, or 8 ignition box.

Note: Standard deck height blocks only. Will not fit gen 5 and 6 big blocks. No Volume Discount.



**Mallory Unilite Distributor**

A legend returns - the tried and true Mallory Unilite Distributor line is back! The easy three wire hookup of the Unilite makes running a stock coil, a Mallory performance coil and even a Mallory HyFire CD ignition a snap. Supplied with a quality cap and rotor, the Mallory Unilite also provides a fully adjustable mechanical advance to dial in the perfect timing curve for a multitude of engine combinations. The Unilite features a compact housing that lends itself well to applications where space is a premium due to tight firewall clearance or blower applications.

|             |               |       |            |
|-------------|---------------|-------|------------|
| MAL-3748201 | All SBC, BBC* | ..... | 335.99 ea. |
|-------------|---------------|-------|------------|

\*Standard deck height blocks only. Will not fit gen 5 and 6 big blocks. No Volume Discount.

**IGNITION & RELATED**



MSD-6201



**MSD Ignition**

An MSD Ignition will improve the overall performance of your engine thanks to its high output capacitive discharge sparks. Below 3,000 rpm the ignition delivers multiple sparks that will clean up the idle, improve starting and throttle response. If you're looking to improve the performance of your modified mill, we have the answer. Whether you've done a cam swap, or bolted on a carb, intake and headers, the 6A is a surefire way to harness all the ponies under your hood. Step up to the 6AL to have an engine saving rev limiter.

|           |               |       |            |
|-----------|---------------|-------|------------|
| MSD-6201  | Red All 6A    | ..... | 245.99 ea. |
| MSD-6425  | Red All 6AL   | ..... | 284.99 ea. |
| MSD-64253 | Black All 6AL | ..... | 284.99 ea. |
| MSD-6421  | Red All 6AL-2 | ..... | 338.99 ea. |

No Volume Discount.



GAC-505

**Coil**

Choose from our new reproduction Delco coils with GM numbers or GM replacement coil.

|         |                     |       |           |
|---------|---------------------|-------|-----------|
| GAC-505 | 1964-73 All Replace | ..... | 39.95 ea. |
|---------|---------------------|-------|-----------|

\*427/454 transistor ignition. No Volume Discount.



GCS-S2039BK

**External Ignition Coils**

Choose from our upgraded external ignition coils. 45,000-volt output. Anodized finish, includes pigtails and hardware for installation.

|              |            |       |           |
|--------------|------------|-------|-----------|
| GCS-S2039BK  | All, Black | ..... | 55.99 ea. |
| GCS-S2039BLU | All, Blue  | ..... | 55.99 ea. |



APJ-5240

**Ground Strap Kit**

Correct braided copper wire and ends complete with OEM screws.

|          |               |       |           |
|----------|---------------|-------|-----------|
| APJ-5240 | 1964+ (3 pc.) | ..... | 19.95 kit |
|----------|---------------|-------|-----------|

**SPARK PLUG WIRES**



APX-1300



APX-8100



APX-1200

**Wire Separators**

Correct spark plug wire separators.

|          |                         |       |           |
|----------|-------------------------|-------|-----------|
| APX-1300 | 1969-72 SB/BB Left Rear | ..... | 16.95 ea. |
| APX-1200 | 1969-72 SB Left Front   | ..... | 17.99 ea. |
| APX-8100 | All BB Right Side       | ..... | 15.95 ea. |

AX-423

AX-486

AX-486A

**Spark Plug Wire Stands**

New reproduction of originals.

|         |                            |       |           |
|---------|----------------------------|-------|-----------|
| AX-423  | All SB (Right Side)        | ..... | 14.95 ea. |
| AX-486A | 1968 All SB (Left Side)    | ..... | 27.95 ea. |
| AX-486  | 1969-72 All SB (Left Side) | ..... | 27.95 ea. |



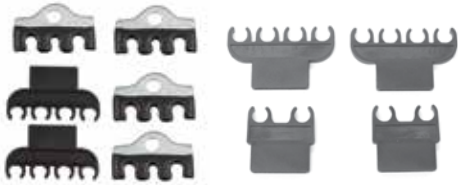

APX-5022

APX-5023

**Valve Cover Spark Plug Wire Loom Kits**

Correct spark plug wire separators for valve covers.

|          |                 |           |
|----------|-----------------|-----------|
| APX-5022 | SB (6 pc.)..... | 21.99 kit |
| APX-5023 | BB (4 pc.)..... | 11.95 kit |

**Flaming River Single Wire Timing Light**

This self-powered timing light is designed to work without an auxiliary power source, which makes it ideal for use with magnetos, rear battery mount race cars and all spark ignition systems



for hassle-free timing. The Light is equipped with a xenon bulb which generates a bright strobe as well as a convenient work light. Durable construction includes a rubber encased lens and 48 degree pickup lead. State of the art single wire design is operated by two D-Cell batteries. Accurate timing up to 14,000 RPM.

|        |                 |           |
|--------|-----------------|-----------|
| FR1001 | Universal ..... | 96.99 ea. |
|--------|-----------------|-----------|

*No Volume Discount.*



**"Dated" Spark Plug Wire Set**

New reproduction wire set correctly dated for your specific car, pre-cut and ready to install! Each set features correct colored wires and correct angle "cut" boots. Please give your sales rep your desired date. Non-HEI cars only. Here's how to order:

|            |           |
|------------|-----------|
| ALL-70BB1Q | 79.99 set |
|------------|-----------|

*\*For example, if the build date of your car was on or before January 15th of the model year order 3rd quarter of the previous year. If the build date was after January 15th of the model year order 1st quarter of that year. i.e. A 1970 Chevelle built on or before Jan 15th of 1970 would receive 3-Q-69 and after would be 1-Q-70.*



AHC-1508

**Spark Plug Wire Sets**

New pre-cut OEM replacements.

|          |                 |           |
|----------|-----------------|-----------|
| AHC-1508 | All SB.....     | 39.95 set |
| AHC-2508 | All BB.....     | 39.95 set |
| AHC-3508 | All w/ HEI..... | 54.99 set |



MSD-35593

**MSD Ignition Spark Plug Wires**

Engineered from the inside out, the 8.5 offers everything you have ever wanted in a wire; incredibly low resistance without electronic interference! In a single 12 inch length of Super Conductor Wire there is only 40 - 50 ohms of resistance!

Without Headers

|           |                                   |           |
|-----------|-----------------------------------|-----------|
| MSD-31359 | Red, SBC 350 HEI w/o Headers..... | 98.99 kit |
|-----------|-----------------------------------|-----------|

With Headers

|           |                                    |            |
|-----------|------------------------------------|------------|
| MSD-35593 | Black, SBC 350 HEI* Cap .....      | 102.99 kit |
| MSD-35599 | Red, SBC 350 HEI* Cap.....         | 102.99 kit |
| MSD-35603 | Black, BBC 350 HEI* Tower Cap ...  | 107.99 kit |
| MSD-35609 | Red, BBC 350 HEI* Tower Cap ....   | 107.99 kit |
| MSD-35653 | Black, SBC 350 HEI* Tower Cap. ... | 105.99 kit |
| MSD-35659 | Black, SBC 350 HEI* Cap .....      | 105.99 kit |

*\*Works on any HEI or MSD style cap with male terminals.*

*No Volume Discount.*

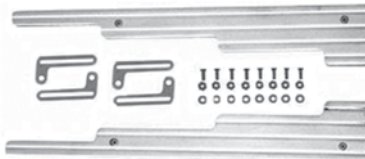

GCS-S6038



GCS-S6038X

**Billet Spark Plug Wire Looms Small Block**

These wire looms will keep your spark plug wires neat and organized, minimizing wear on the wires. Also prevents cross firing and grounding of the wires. Choose from plain, ball milled or milled flames in either polished billet or chrome billet. Includes mounting hardware.

|             |                           |           |
|-------------|---------------------------|-----------|
| GCS-S6039   | Plain, Polished .....     | 47.99 kit |
| GCS-S6039C  | Plain, Chrome .....       | 59.99 kit |
| GCS-S6038   | Ball Mill, Polished ..... | 41.99 kit |
| GCS-S6038C  | Ball Mill, Chrome .....   | 62.99 kit |
| GCS-S6038X  | Flames, Polished .....    | 52.99 kit |
| GCS-S6038XC | Flames, Chrome .....      | 64.99 kit |

*Note: Fits up to 9.5 mm wires.*

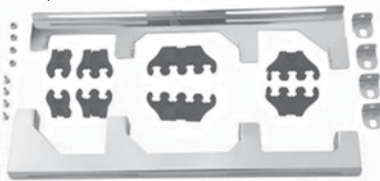

GCS-S7251

**Universal Chrome Wire Looms Big Block**

These wire looms will keep your spark plug wires neat and organized, minimizing wear on the wires. Also prevents cross firing and grounding of the wires.

|           |                 |           |
|-----------|-----------------|-----------|
| GCS-S7251 | Universal ..... | 20.99 kit |
|-----------|-----------------|-----------|

*Note: Fits up to 9 mm wires.*



AC43

**AC Delco Spark Plugs**

This is a brand new set of 8 spark plugs for your Chevrolet. These high quality reproduction AC Delco spark plugs feature the correct green AC and markings as original.

|      |                   |           |
|------|-------------------|-----------|
| AC43 | 1964-70 #43 ..... | 59.95 set |
| AC44 | 1964-70 #44 ..... | 59.95 set |
| AC45 | 1964-70 #45 ..... | 59.95 set |

*Note: The number on the plug refers to it's operating temperature. The lower number is a cooler running plug which is typically found on the SHP high performance engines. A hotter, higher numbered plug would be used in engines where plug fouling may be or is a problem.*



APX-650

**Spark Plug Heat Shield Kit SB**

Correct die stamped shields and arms for most small blocks without Rams Horn style manifolds. Complete with mounting hardware.

|         |                 |           |
|---------|-----------------|-----------|
| APX-650 | 1964-72 SB..... | 36.95 kit |
| BXX-650 | Bolts (4) ..... | 1.00 kit  |



AT-3030

**OEM Style Spark Plug Heat Shield Kit BB**

This is a set of correctly stamped spark plug heat shields which are silver Cadmium plated just as original.

|         |                  |           |
|---------|------------------|-----------|
| AT-3030 | 1965-72 BB ..... | 49.95 kit |
|---------|------------------|-----------|



APX-6584

**Spark Plug Heat Shield Kit BB**

Correct stamped shields for various Chevrolet cars with BB engines (8pcs).

|          |                  |           |
|----------|------------------|-----------|
| APX-6584 | 1965-72 BB ..... | 38.95 kit |
|----------|------------------|-----------|

**SMOG**



AD-052



AZ-840



ASH-695

**Smog Tube & Extension**

Correct pre-bent powder coated AIR smog tubes and extensions.

|        |                               |           |
|--------|-------------------------------|-----------|
| AD-252 | 1969-72 SB Tubes w/o AC ..... | 89.95 pr. |
| AD-052 | 1969-72 BB Tubes w/o AC ..... | 89.95 pr. |
| AZ-840 | 1967-72 Extension .....       | 8.95 ea.  |

**Smog Hose Kit**

Original OEM ribbed hose complete with white stripe vacuum hose, T fittings and clamps.

|         |                            |             |
|---------|----------------------------|-------------|
| ASH-695 | All SB Complete .....      | 41.95 kit   |
| ASH-69B | All BB Complete .....      | 41.95 kit   |
| CPN-100 | OEM Vacuum Hose Only ..... | 1.95 per ft |

**VALVE COVERS**

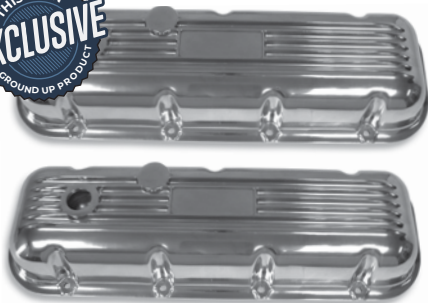

AVC-100

**"Motion" Valve Covers**

Original style Cal Custom finned valve covers featuring the notorious Baldwin Motion die cast logos.

|           |                        |            |
|-----------|------------------------|------------|
| AVC-100   | Most BB (Blank) .....  | 179.95 pr. |
| MOTION-VC | Most BB "Motion" ..... | 289.95 pr. |

Note: 2-5/8" - 3" inside clearance.



ATE-4207

**Finned Aluminum Valve Covers**

Reproduction of original GM high performance valve covers.

|          |                  |            |
|----------|------------------|------------|
| ATE-4207 | SB .....         | 229.99 pr. |
| HVC-28   | Flag Decal ..... | 8.95 ea.   |

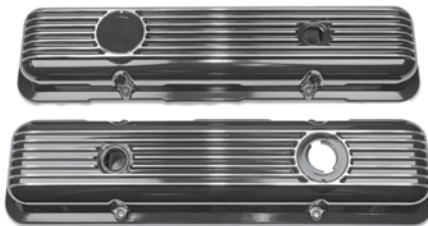

ATE-4207-BLK

**Finned Aluminum Valve Covers - Black**

Black finned aluminum valve covers based on the popular LT-1 covers.

|              |          |            |
|--------------|----------|------------|
| ATE-4207-BLK | SB ..... | 229.95 pr. |
|--------------|----------|------------|



AVC-542

**1968 Small Block SHP Valve Covers**

Accurate reproductions of the original 1968 Special High Performance (SHP) valve covers in chrome or ready to paint EDP coating.

|         |                 |            |
|---------|-----------------|------------|
| AVC-542 | Chrome .....    | 139.99 pr. |
| AVC-543 | Paintable ..... | 129.99 pr. |



GCS-S6142



GCS-S6142G

**Fabricated LS1 Valve Covers**

2.5" height to clear aftermarket valve train. Includes oil cap, O-ring type gasket and bolts. Available with or without mounts for coil brackets.

|               |   |            |
|---------------|---|------------|
| GCS-S6141     | LS1, No Coil Bracket Mounts, Anodized ..... | 192.99 pr. |
| GCS-S6141C    | LS1, No Coil Bracket Mounts, Chrome .....   | 216.99 pr. |
| GCS-S6141POL  | LS1, No Coil Bracket Mounts, Polished ..... | 209.99 pr. |
| GCS-S6142     | LS1, w/ Coil Bracket Mounts, Anodized ..... | 168.99 pr. |
| GCS-S6142C    | LS1, w/ Coil Bracket Mounts, Chrome .....   | 204.99 pr. |
| GCS-S6142POL  | LS1, w/ Coil Bracket Mounts, Polished ..... | 192.99 pr. |
| GCS-S6142G    | LS1 O-Ring Type Gasket .....                | 7.99 pr.   |
| GCS-S6142BOLT | LS1 Valve Cover Bolt Kit .....              | 7.99 kit   |
| GCS-S6143     | LS1 Coil Mounting Brackets .....            | 24.99 pr.  |



GCS-S6145BK



GCS-S6145POL

**Fabricated Tall Height Valve Covers**

High quality fabricated aluminum valve covers. Mounting hardware included. Available with or without breather holes.

|                      |  |            |
|----------------------|--|------------|
| GCS-S6144C           | SB, No Hole, Chrome .....                | 179.99 pr. |
| GCS-S6144POL         | SB, No Hole, Polished .....              | 144.99 pr. |
| GCS-S6144BK          | SB, No Hole, Black .....                 | 156.99 pr. |
| <i>3-3/4" height</i> |  |            |
| GCS-S6145            | SB, Flat Top, w/ Hole, Anodized .....    | 144.99 pr. |
| GCS-S6145C           | SB, Flat Top, w/ Hole, Chrome .....      | 156.99 pr. |
| GCS-S6145POL         | SB, Flat Top, w/ Hole, Polished .....    | 144.99 pr. |
| GCS-S6145BK          | SB, Flat Top, w/ Hole, Black .....       | 156.99 pr. |
| GCS-S6147            | SB, Flat Top, No Hole, Anodized .....    | 119.99 pr. |
| GCS-S6147C           | SB, Flat Top, No Hole, Chrome .....      | 148.99 pr. |
| GCS-S6147POL         | SB, Flat Top, No Hole, Polished .....    | 119.99 pr. |
| <i>3-7/8" height</i> |  |            |
| GCS-S6243            | BB, Long Screw, w/ Hole, Anodized .....  | 164.99 pr. |
| GCS-S6243C           | BB, Long Screw, w/ Hole, Chrome .....    | 192.99 pr. |
| GCS-S6243POL         | BB, Long Screw, w/ Hole, Polished .....  | 179.99 pr. |
| GCS-S6244            | BB, Long Screw, No Hole, Anodized .....  | 168.99 pr. |
| GCS-S6244C           | BB, Long Screw, No Hole, Chrome .....    | 192.99 pr. |
| GCS-S6244POL         | BB, Long Screw, No Hole, Polished .....  | 180.99 pr. |
| GCS-S6244BK          | BB, Long Screw, No Hole, Black .....     | 192.99 pr. |
| <i>3 1/2" height</i> |  |            |
| GCS-S6248            | BB, Short Screw, w/ Hole, Anodized ..... | 162.99 pr. |
| GCS-S6248C           | BB, Short Screw, w/ Hole, Chrome .....   | 186.99 pr. |
| GCS-S6248POL         | BB, Short Screw, w/ Hole, Polished ..... | 180.99 pr. |
| GCS-S6248BK          | BB, Short Screw, w/ Hole, Black .....    | 204.99 pr. |
| GCS-S6249            | BB, Short Screw, No Hole, Anodized ..... | 168.99 pr. |
| GCS-S6249C           | BB, Short Screw, No Hole, Chrome .....   | 186.99 pr. |
| GCS-S6249POL         | BB, Short Screw, No Hole, Polished ..... | 180.99 pr. |



GCS-S6047BK

**Small Block Center Bolt Ball Milled Valve Covers**

These aluminum valve covers are a great custom touch to any street machine or sleeper.

GCS-S6047BK Center Bolt Small Block.....111.99 pr.  
Fits 1987 and newer small block with center bolt heads except LS.



GCS-S6336

**Small Block Tall Valve Covers**

These high quality small block Chevy valve covers are a great way to dress up your motor, as well as gain some extra clearance for roller rockers.

GCS-S6336 Chevrolet Logo, Black .....241.99 pr.  
GCS-S7618 Chevrolet Logo, Orange .....230.99 pr.  
GCS-S6341POL Chevrolet Logo, Polished .....314.99 pr.  
GCS-S7617 383 Stroker Logo, Black .....209.99 pr.  
GCS-S7619 383 Stroker Logo, Orange .....220.99 pr.  
GCS-S6342POL 383 Stroker Logo, Polished .....314.99 pr.



AVC-540



**1967 Chevrolet Script Valve Covers**

Excellent reproductions of the original stamped "Chevrolet" valve covers in chrome or ready to paint EDP coating. These valve covers feature the correct wire retainers and "O" stamp.

AVC-540 Chrome .....169.99 pr.  
AVC-541 Paintable .....129.99 pr.



XA-101S-OE



**BUY'N SAVE**  
WITH KITS

**Big Block Valve Cover Kit**

Save money on our complete kit! All kits come complete with the following items: (2) valve covers, (2) gaskets, valve cover retainers and TR bolts, (2) V.C. grommets, V.C. oil cap, V.C. elbow and hose and V.C. wire separators.

XA-101 w/o Left Slant w/ Drippers .....139.08 kit  
XA-101S w/ Left Side Slant\* w/ Drippers .....139.08 kit

\*Use slanted valve covers when brake booster clearance may be an issue.

OE kits with silver gaskets, correct oil cap and Tonawanda decal.

XA-101-OE w/o Left Slant w/ Drippers .....162.07 kit  
XA-101S-OE w/ Left Slant\* w/ Drippers .....162.07 kit

\*Use slanted valve covers when brake booster clearance may be an issue.



ALS-1065

**Original Style Chrome Valve Covers**

These reproduction covers offer the highest quality chrome plating, correct wire stands and factory oil deflectors "drippers". Valve covers are available with a left side slant to increase booster clearance in tight engine compartments. Also available in tall style to fit roller rockers.

ALS-1065 All BB w/o Slant ..... 99.95 pr.  
ALS-1165 All BB w/ Left Side Slant..... 99.95 pr.  
ACC-3362 All BB w/o Drippers..... 38.99 pr.  
ACC-3365 All BB w/ Slant w/o Drippers..... 31.99 pr.  
ALS-1065XT All BB Tall w/o Left Slant..... 89.95 pr.  
ALS-1165XT All BB Tall w/ Left Slant..... 89.95 pr.

**VALVE COVERS** *continued*



**THIS IS AN EXCLUSIVE**  
GROUND UP PRODUCT

396TJC-1

**"Turbo Jet" Valve Covers**

Cal Custom finned valve covers featuring the famous "Turbo Jet" medallions.

|          |                    |            |
|----------|--------------------|------------|
| 396TJC-1 | All BB "396" ..... | 249.99 pr. |
| 427TJC-1 | All BB "427" ..... | 229.95 pr. |
| 454TJC-1 | All BB "454" ..... | 229.95 pr. |
| 502TJC-1 | All BB "502" ..... | 229.95 pr. |
| 572TJC-1 | All BB "572" ..... | 229.95 pr. |

2-5/8" - 3" inside clearance. Will work with most roller rockers.



**THIS IS AN EXCLUSIVE**  
GROUND UP PRODUCT

427VC-1

**"427" Valve Covers**

Like our "YENKO" covers with cast "427" medallions.

|         |                         |            |
|---------|-------------------------|------------|
| 427VC-1 | Most BB "427" .....     | 229.95 pr. |
| 427VC-R | Most BB "427" Red ..... | 229.95 pr. |

2-5/8" - 3" inside clearance. Will work with roller rockers.



AT-3662



AT-3666

**Small Block Valve Covers**

New original style early small block Chevrolet covers. These covers come ready to install in correct Chevrolet Orange or chrome plated.

|         |                        |            |
|---------|------------------------|------------|
| AT-3662 | SB Chrome Covers ..... | 119.95 pr. |
| AT-3666 | SB Orange Covers ..... | 99.95 pr.  |



**THIS IS AN EXCLUSIVE**  
GROUND UP PRODUCT

454VC-R

**"454" Valve Covers**

Original Cal Custom style valve covers featuring red "454" medallions.

|         |                     |            |
|---------|---------------------|------------|
| 454VC-R | Most BB "454" ..... | 229.95 pr. |
|---------|---------------------|------------|

2-5/8" - 3" inside clearance. Will work with most roller rockers.



**THIS IS AN EXCLUSIVE**  
GROUND UP PRODUCT

HARREL-VC

**Dick Harrel Aluminum Valve Covers**

"Cal Custom" finned aluminum covers feature the notorious Dick Harrel die cast medallions.

|           |               |            |
|-----------|---------------|------------|
| HARREL-VC | Most BB ..... | 229.95 pr. |
|-----------|---------------|------------|

2-5/8" - 3" inside clearance. Will work with most roller rockers.



GCS-9215B

**Black Painted Valve Covers**

This is a pair of high quality tall black painted valve covers. A great inexpensive custom touch to any street machine or sleeper!

|           |                  |           |
|-----------|------------------|-----------|
| GCS-9215B | 1964-77 SB ..... | 31.99 pr. |
|-----------|------------------|-----------|



**THIS IS AN EXCLUSIVE**  
GROUND UP PRODUCT

SS427VC-R

**"SS 427" Valve Covers**

Original Cal Custom style valve covers featuring red "SS 427" medallions.

|           |                        |            |
|-----------|------------------------|------------|
| SS427VC-R | Most BB "SS 427" ..... | 279.95 pr. |
|-----------|------------------------|------------|

2-5/8" - 3" inside clearance. Will work with most roller rockers.



**THIS IS AN EXCLUSIVE**  
GROUND UP PRODUCT

YSCVC-1

**"Yenko" Valve Covers**

These "Cal Custom" style finned aluminum covers feature the notorious "YENKO" Red, White and Blue die cast logos.

|         |                       |            |
|---------|-----------------------|------------|
| YSCVC-1 | Most BB "YENKO" ..... | 229.95 pr. |
|---------|-----------------------|------------|

2-5/8" - 3" inside clearance



ALS-1165-OJ

**Big Block Valve Covers - Chevrolet Orange**

This is a pair of brand new big block valve covers painted in Chevy orange. These valve covers are correct for most big blocks and will fit cars with power brakes.

|             |                     |            |
|-------------|---------------------|------------|
| ALS-1165-OJ | All Big Block ..... | 109.99 pr. |
|-------------|---------------------|------------|

**VALVE COVER HARDWARE**



AFP-059

**Valve Cover Gaskets**

|          |                           |           |
|----------|---------------------------|-----------|
| AFP-057  | All SB.....               | 13.95 pr. |
| AFP-059  | All BB.....               | 13.95 pr. |
| AFI-9797 | BB w/ Silver Coating..... | 19.99 pr. |



APB-1027

APB-1023

**Valve Cover Retainers OEM Bolt Kits**

Correct steel stamped zinc plated retainers & OEM bolts.

|          |                            |           |
|----------|----------------------------|-----------|
| APB-1023 | SB TR Bolts (16 pc.).....  | 14.95 kit |
| APB-2023 | BB TR Bolts (28 pc.).....  | 23.95 kit |
| APB-1027 | SB M Aluminum (8 pc.)..... | 16.99 kit |



APO-2043



APR-2136

**Valve Cover Oil Caps**

Choose from either chrome GM replacement, chrome reproduction with correct "S" or black rubber push-in cap.

|          |                       |           |
|----------|-----------------------|-----------|
| APX-5763 | Replacement.....      | 6.95 ea.  |
| APR-2136 | Reproduction "S"..... | 16.95 ea. |
| APO-2043 | Rubber "OIL".....     | 5.95 ea.  |



APB-3509

APB-3508

**Valve Cover Grommet Original GM**

|          |             |          |
|----------|-------------|----------|
| APB-3508 | All SB..... | 8.99 pr. |
| APB-3509 | All BB..... | 7.95 pr. |



APT-3509



APT-3960

**Valve Cover Elbows**

Correct GM steel valve cover elbows.

|          |             |           |
|----------|-------------|-----------|
| APT-3960 | All SB..... | 12.95 ea. |
| APT-3509 | All BB..... | 11.95 ea. |



APH-3843



APH-2109

**Valve Cover Hose**

Correct marked OEM hose which extends from valve cover to air cleaner base. Choose from open or closed element.

|          |                                |           |
|----------|--------------------------------|-----------|
| APH-3961 | All SB Open.....               | 11.95 ea. |
| APH-3843 | All BB Open.....               | 4.95 ea.  |
| APH-2109 | 1970-72 BB Closed Element..... | 12.95 ea. |

**OIL PAN & RELATED**



AEH-999

**Oil Pans**

OEM supplier.

|         |                         |            |
|---------|-------------------------|------------|
| AJ-221  | 1964-72 SB w/o SHP..... | 129.99 ea. |
| AEH-999 | 1965-72 All BB.....     | 199.99 ea. |



**Small Block Finned Aluminum Oil Pans**

These finned aluminum oil pans will help keep your oil cooler and add some custom style to your street machine or sleeper. New mounting bolts and drain plug are included.

|   |                 |           |
|---|-----------------|-----------|
| GCS-S8442BK   | 1955-79 SB..... | 99.99 ea. |
| <i>2-piece rear main seal, drivers side dipstick.</i>   |                 |           |
| GCS-S8443BK   | 1980-85 SB..... | 96.99 ea. |
| <i>2-piece rear main seal, passenger side dipstick.</i> |                 |           |
| GCS-S8444BK   | 1986 + SB.....  | 99.99 ea. |
| <i>1-piece rear main seal, passenger side dipstick.</i> |                 |           |



APC-744

**Oil Pan Clip**

Correct clip for retaining positive battery cable routing to solenoid.

|         |                |          |
|---------|----------------|----------|
| APC-744 | All SB-BB..... | 5.95 ea. |
|---------|----------------|----------|



BPO-1988

**Oil Drain Bolt/Washer**

Original GM.

|          |                |          |
|----------|----------------|----------|
| BPO-1988 | All SB/BB..... | 6.95 ea. |
|----------|----------------|----------|



ACP-1SB

**Oil Pan Gasket Set**

Correct OEM gaskets.

|         |             |           |
|---------|-------------|-----------|
| ACP-1SB | All SB..... | 19.95 ea. |
| ACP-2BB | All BB..... | 16.95 ea. |



BOP-2002

**Oil Pan Attaching OEM Bolt Kit**

Correct "L" head marked bolts for attaching pan to block

|          |                      |           |
|----------|----------------------|-----------|
| BOP-2001 | All SB (18 pc.)..... | 9.95 ea.  |
| BOP-2002 | All BB (24 pc.)..... | 13.99 ea. |



AJ-4

**Oil Pan Baffle / Windage Tray**

Often installed on most High Performance cars, this "windage tray" was used to keep oil from splashing the crankshaft. A MUST!

|      |                  |           |
|------|------------------|-----------|
| AJ-4 | Small Block..... | 44.99 ea. |
| AJ-6 | Big Block.....   | 23.95 ea. |



NFX-25



NF-25

**Oil Canister - Filter**

Reproduction of early canister style filter.

|        |                              |           |
|--------|------------------------------|-----------|
| NFX-25 | PF-25 AC Filter "White"..... | 24.99 ea. |
| NF-25  | PF-25F AC Filter "Blue"..... | 9.99 ea.  |



KN-HP2002



KN-PS2002



**K&N Oil Filters**

K&N Performance Oil Filters have been specially designed for professional installers and service providers. Their high flow design can help to improve engine performance by reducing oil filter restriction. Performance Gold Oil Filters have a Premium Wrench-Off design and have become a favorite among consumers for its durability and easy removal. Our Performance Silver Oil Filters have a fluted canister shape so they can be removed with a traditional oil filter wrench commonly available to commercial installers. These Performance oil filters provide outstanding filtration and engine protection throughout their service life. They are engineered to handle all grades of synthetic, conventional and blended motor oils. The pleated media provides high capacity making them suitable for extended oil change intervals when used in accordance with the vehicle and motor oil manufacturers recommendation.

|           |                                     |           |
|-----------|-------------------------------------|-----------|
| KN-HP2002 | 1962-79 Gold Wrench Off.....        | 11.99 ea. |
| KN-PS2002 | 1962-79 Silver Standard Fluted..... | 8.99 ea.  |

*No Volume Discount.*



**Oil Pressure Fittings**

|         |                            |           |
|---------|----------------------------|-----------|
| N-137   | 1968+ All SB .....         | 6.99 ea.  |
| N-133   | All BB w/o SHP .....       | 16.95 ea. |
| N-142   | All BB w/ SHP .....        | 26.95 ea. |
| N-A6474 | Back of Gauge Fitting..... | 6.95 ea.  |

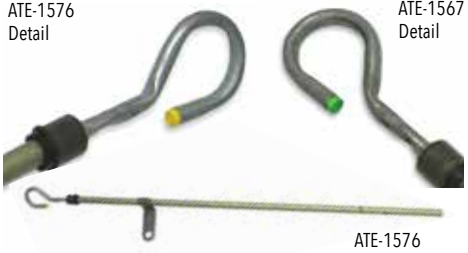

**Oil Dipstick Kits**  
Complete with tube and gauge (stick)

|          |                              |           |
|----------|------------------------------|-----------|
| ATE-1576 | 1964-79 SB (Green Dot) ..... | 31.99 ea. |
| ATE-1576 | 1965-72 BB (Yellow Dot)..... | 49.95 ea. |

**PCV & TCS RELATED**

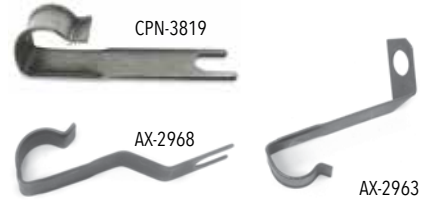

**PCV Retaining Hose Clip**  
Reproduction of original PCV hose retaining clip, with correct bends and black phosphate coating.

|          |                        |           |
|----------|------------------------|-----------|
| CPN-3819 | All w/ Holley .....    | 16.99 ea. |
| AX-2963  | 1965-67 BB Q-Jet ..... | 13.95 ea. |
| AX-2968  | 1966 BB 360 HP .....   | 16.99 ea. |



**Oil Pressure Lines**  
Correct material lines with correct fittings for all cars with gauges.

|          |                             |           |
|----------|-----------------------------|-----------|
| N-1131   | 1964-67 (Steel Coiled)..... | 33.95 ea. |
| CHO-3200 | 1968+ (Black Plastic).....  | 9.99 ea.  |



**Chrome Dipsticks w/ Braided Tubes**  
Stainless steel braided tube with chrome handle.

**Bell Housing Mount**

|           |                |           |
|-----------|----------------|-----------|
| GCS-S5004 | TH350 .....    | 42.99 ea. |
| GCS-S5005 | TH400 .....    | 42.99 ea. |
| GCS-S5006 | TH700-R4 ..... | 42.99 ea. |

**Firewall Mount**

|           |                       |           |
|-----------|-----------------------|-----------|
| GCS-S5104 | TH350/TH400 29" ..... | 48.99 ea. |
| GCS-S5106 | TH700-R4 .....        | 48.99 ea. |



**TCS Littlefuse Relay**  
This is an reproduction of the correct littlefuse TCS relay. This authentic reproduction features 4 prongs as original.

|          |               |           |
|----------|---------------|-----------|
| ATCS-33R | 1970-72 ..... | 54.95 ea. |
|----------|---------------|-----------|



**Oil Pressure Switches**  
Correct GM switches for cars without manual gauges.

|         |                          |           |
|---------|--------------------------|-----------|
| GAC-310 | 1969 w/ Gauges.....      | 33.95 ea. |
| GAC-110 | 1970-72 w/ Gauges .....  | 11.95 ea. |
| GAC-110 | 1964-72 w/o Gauges ..... | 11.95 ea. |



**Billet Engine Dipstick with Braided Tube**  
Show quality billet aluminum dipstick with braided tube.

|           |                  |           |
|-----------|------------------|-----------|
| GCS-S5002 | 1955-79 SB ..... | 36.99 ea. |
| GCS-S5001 | 1980-95 SB ..... | 36.99 ea. |
| GCS-S5003 | 1965-90 BB ..... | 42.99 ea. |

*Note: Oil level varies depending on the oil pan used. You may need to mark the dipstick with your own new full level mark.*



**TCS Transmission Switches**  
Correct TCS switch located on transmission.

|          |                           |           |
|----------|---------------------------|-----------|
| ATS-21MP | 1970-75 Pin Style .....   | 32.95 ea. |
| ATS-21MS | 1970-75 Spade Style ..... | 32.95 ea. |



**Chrome Transmission Dipsticks and Tubes**  
Show quality dipsticks are an excellent upgrade to any engine compartment. Includes dipstick & tube.

|             |                              |           |
|-------------|------------------------------|-----------|
| GCS-S4922   | Powerglide.....              | 13.99 ea. |
| GCS-S9421   | TH350 .....                  | 12.99 ea. |
| GCS-S9421BA | TH350 Billet Handle .....    | 21.99 ea. |
| GCS-S4994   | TH350 34" .....              | 13.99 ea. |
| GCS-S4994BA | TH350 34" Billet Handle..... | 17.99 ea. |
| GCS-S4995   | TH400 24" .....              | 10.99 ea. |
| GCS-S4995BA | TH400 24" Billet Handle..... | 14.99 ea. |



**Billet Aluminum Engine Dipstick**  
Show quality dipstick with billet handle. 11.5" length.

|           |              |           |
|-----------|--------------|-----------|
| GCS-S6060 | Handle ..... | 15.99 ea. |
|-----------|--------------|-----------|

*Note: Oil level varies depending on the oil pan used. You may need to mark the dipstick with your own new full level mark.*



**TCS Wire Retainer**  
Correct reproduction for Muncie.

|         |                         |           |
|---------|-------------------------|-----------|
| ATS-653 | 1970-74 w/ Muncie ..... | 19.95 ea. |
|---------|-------------------------|-----------|



**Chrome/Billet Dipsticks & Tubes**  
Show quality dipsticks with matching tubes. A great upgrade to any engine compartment!

|             |                                 |           |
|-------------|---------------------------------|-----------|
| GCS-S4957   | 1955-79 SB, Chrome, 19" .....   | 5.99 ea.  |
| GCS-S4957BA | 1955-79 SB, Billet, 19" .....   | 10.99 ea. |
| GCS-S9420   | 1980-82 SB, Chrome, 23" .....   | 7.99 ea.  |
| GCS-S9420BA | 1980-82 SB, Billet, 23" .....   | 12.99 ea. |
| GCS-S9231   | 1983-85 SB, Chrome, 24.5".....  | 9.99 ea.  |
| GCS-S9231BA | 1983-85 SB, Billet, 24.5" ..... | 10.99 ea. |
| GCS-S4958   | 1965-90 BB, Chrome, 21".....    | 7.99 ea.  |
| GCS-S4958BA | 1965-90 BB, Billet, 21" .....   | 10.99 ea. |

*Note: Oil level varies depending on the oil pan used. You may need to mark the dipstick with your own new full level mark.*



**Engine Block Lifting Ring**  
These correct steel stamped lifting rings were installed at the engine plant for ease of installation.

|          |                         |           |
|----------|-------------------------|-----------|
| APX-1015 | Most SB .....           | 25.99 set |
| APX-1115 | All BB .....            | 25.99 set |
| BPX-230  | Lifting Ring Bolt ..... | 0.95 ea.  |



**Motor Mount Clip**  
Correct clip for attaching positive cable to right side motor mount.

|          |                |           |
|----------|----------------|-----------|
| ATW-2853 | Most V8's..... | 19.95 ea. |
|----------|----------------|-----------|

**MOTOR MOUNTS & RELATED**

**THIS IS AN EXCLUSIVE GROUND UP PRODUCT**

AMC-103KIT

**Engine Mounting Kits**  
Perfect for converting to a V8 or for upgrading your small block to a big block! Each kit includes all of the necessary motor mounts, frame brackets, motor mount thru bolts, frame bracket bolts and motor mount to block bolts so you can do the job right!

|             |            |            |
|-------------|------------|------------|
| AMC-10SBKIT | 1964-67 SB | 125.59 kit |
| AMC-103KIT  | 1964-67 BB | 117.09 kit |
| ACE-9794KIT | 1968-72 V8 | 129.84 kit |

No Volume Discount.

ENG-103KIT-G

**Poly Engine Mount Kits**  
Same as our OE style engine mount kits with upgraded Energy Suspension Poly motor mounts. The poly mounts can take the abuse of todays high performance engines, yet still absorb driveline vibrations. They are available in Poly Graphite black or red.

|               |                       |            |
|---------------|-----------------------|------------|
| ENG-10SBKIT-G | 1964-67 SB Black      | 182.16 kit |
| ENG-10SBKIT-R | 1964-67 SB Red        | 182.16 kit |
| ENG-103KIT-G  | 1964-67 BB Black      | 173.66 kit |
| ENG-103KIT-R  | 1964-67 BB Red        | 173.66 kit |
| ENG-9794KIT-G | 1968-72 V8 ALL* Black | 162.16 kit |
| ENG-9794KIT-R | 1968-72 V8 ALL* Red   | 162.16 kit |

\*Except 307. No Volume Discount.

AMC-103

**Frame Brackets**  
Reproduction of the long discontinued GM brackets for mounting the engine to frame of car. Sold in matched pairs.

|          |                               |           |
|----------|-------------------------------|-----------|
| AMC-10SB | 1964-67 SB                    | 89.95 pr. |
| AMC-103  | 1964-67 BB                    | 79.95 pr. |
| ACE-9794 | 1968-72 All V8                | 59.95 pr. |
| APX-2339 | 1964-72 All V8 Bolts To Frame | 6.95 kit  |

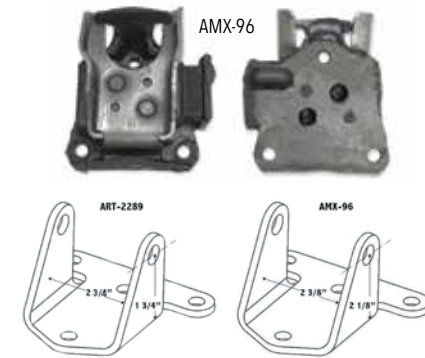

**Motor Mounts OEM**  
These new motor mounts are from GM's original supplier! MADE IN USA!!!

|          |                 |           |
|----------|-----------------|-----------|
| ART-2289 | 1964-67 Most V8 | 32.95 pr. |
| AMX-96   | 1968-72 Most V8 | 69.95 pr. |

Please measure your frame brackets before ordering.  
Use ART-2289 with AMC-10SB & AMC-103. Use AMX-96 for ACE-9794.



**Poly Graphite Motor Mounts**  
Energy Suspension mounts can take the abuse of todays high performance engines. Poly Graphite bushings can last longer than stock rubber mounts while handling more power, yet able to absorb most driveline vibrations. Add G to the part number for black. Add R to part number for red. Example. 3-4114G is for 65-67 in black.

|         |                              |           |
|---------|------------------------------|-----------|
| 3-1114_ | 1964-67 2-5/8" W x 3/4" H    | 46.99 ea. |
| 3-1117_ | 1968-72 2-3/8" W x 1-3/16" H | 50.99 ea. |
| 3-1116_ | 1973-88*                     | 31.99 ea. |

Two mounts required per car.  
\*You must reuse your original clamshells on the 1973-88 by drilling out the rivets and replacing the rubber insert with the new Poly Graphite mount.

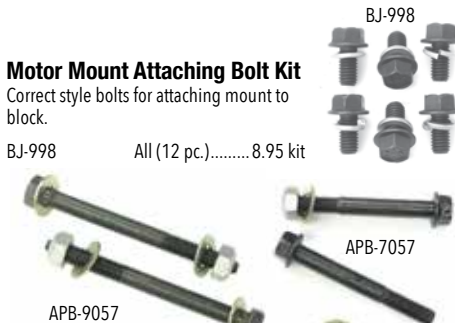

**Motor Mount "Thru" Bolt Kit**  
Correct OEM bolts for retaining mount to frame bracket. Comes complete with special high strength washers and cadmium plated locking nuts as original.

|          |                  |          |
|----------|------------------|----------|
| APB-9057 | 1964-67 All 4.5" | 8.95 kit |
| APB-7057 | 1968-72 All 3.5" | 6.95 kit |

**THROTTLE & ACCELERATOR**



**Stainless Steel Kickdown Cables**  
Show quality look with more adjustability than your factory cable.

|           |          |           |
|-----------|----------|-----------|
| GCS-S6053 | TH350    | 41.99 ea. |
| GCS-S6051 | TH700-R4 | 44.99 ea. |

Note: For carburetor applications only.



**Chrome Throttle Cable Brackets**  
Designed to work with your GM throttle cable on most carburetor applications. Available with or without kickdown provision.

|           |              |          |
|-----------|--------------|----------|
| GCS-S9619 | w/o Kickdown | 9.99 kit |
| GCS-S9620 | w/ Kickdown  | 9.99 kit |

Note: Due to the universal nature of this part fitting and/or modifications may be required.



**Chrome Universal Carburetor Throttle Return Kit**  
Designed to make mounting the spring a snap! Works on most carburetors.

|           |           |          |
|-----------|-----------|----------|
| GCS-S2291 | Universal | 5.99 kit |
|-----------|-----------|----------|

Note: Due to the universal nature of this part fitting and/or modifications may be required.



**Accelerator Cables**  
Choose from GM service replacement cables or new reproductions complete with casings and bushings as original.

|          |                          |           |
|----------|--------------------------|-----------|
| ATH-3863 | 1968-72 SB 2 bbl GM      | 34.99 ea. |
| ATH-2679 | 1968-72 SB 4 bbl GM      | 52.99 ea. |
| ATH-3862 | 1968-72 BB Q-Jet GM      | 39.99 ea. |
| ATH-3369 | 1968-72 BB Holley GM     | 41.95 ea. |
| 336969R  | 1968-72 Repro for Holley | 18.95 ea. |
| 3972679R | 1968-72 Repro for Q-Jet  | 18.95 ea. |
| AZC-88   | 1968-72 Cable Clip GM    | 6.95 ea.  |
| AXJ-CE   | Cable Decal              | 4.95 ea.  |