

GROUND UP[®]

SS396.COM



1967-2018 CAMARO PARTS
& ACCESSORIES CATALOG

30
YEARS

SS396.COM | 866-358-2277 | 91 GREAT HILL RD NAUGATUCK, CT 06770

Dear valued muscle car enthusiast,

When we started Ground Up Restoration 30 years ago, we had one thing in mind: to bring the best quality restoration parts to everyone, from the weekend driver to the 1000 point restoration. As the years progressed, Ground Up grew from a one-person company to the 40,000 square foot facility that we now operate out of Naugatuck, Connecticut. Though we have grown, we are still no different from you. We have maintained the same belief that our customers deserve not only the best parts but also the best customer service available.

With over 30 completed muscle car restorations under our belt, including our original 1968 Chevelle SS396 owned since 1980 (as seen below), to our insane pro-touring 1978 Z/28 LSX Camaro, there's nothing we have not seen or done!

Your restoration is important to us. Whether you need parts, advice, or tech help, Ground Up is here for you! We have some of the best and most knowledgeable customer service and tech reps in the business, waiting to take your call.

Ground Up understands that your restoration is a major part of your life. We are grateful to have the opportunity to be a part of this process for the past 30 years and look forward to 30 more years of continued service.

Thank you for your business, and for being a part of the Ground Up family.

Sincerely,
Team Ground Up

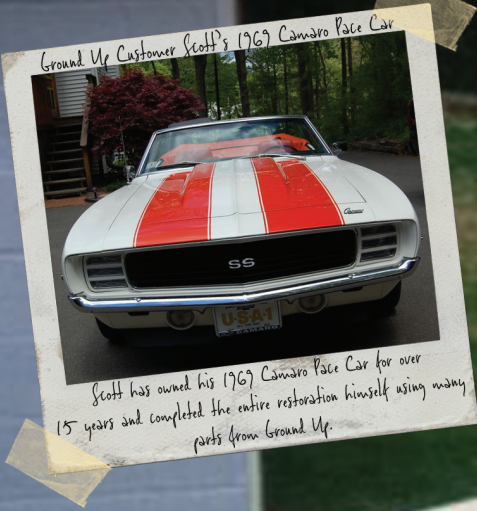

Ground Up Customer Scott's 1967 Camaro Pace Car

Scott has owned his 1967 Camaro Pace Car for over 15 years and completed the entire restoration himself using many parts from Ground Up.

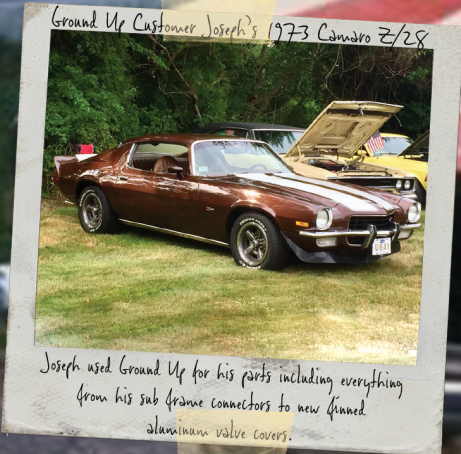

Ground Up Customer Joseph's 1973 Camaro Z/28

Joseph used Ground Up for his parts including everything from his sub frame connectors to new finned aluminum valve covers.



Ground Up Customer Sal's 1967 Camaro Z/28

The car only had about 42,000 miles on it, but Sal didn't think it looked good enough so he restored with all new parts from Ground Up.

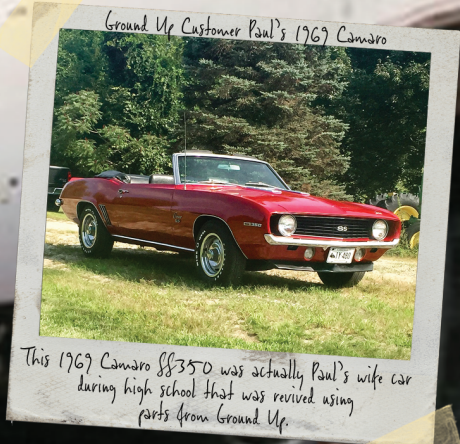

Ground Up Customer Paul's 1967 Camaro

This 1967 Camaro 88-350 was actually Paul's wife car during high school that was revived using parts from Ground Up.

Ground Up Customer Scott's 1969 Camaro Pace Car
#BuiltFromTheGroundUp



THE ULTIMATE SOURCE FOR DETAILING AND RESTORATION PARTS SINCE 1990



POPULAR BRANDS



CHECK US OUT ON SOCIAL!

- [FACEBOOK.COM/GROUNDUPRESTORATION](https://facebook.com/grounduprestoration)
- [INSTAGRAM.COM/GROUNDUPSS396](https://instagram.com/groundupss396)
- [TWITTER.COM/GROUNDUPRESTO](https://twitter.com/groundupresto)
- [YOUTUBE.COM/GROUNDUPRESTO](https://youtube.com/groundupresto)

PRICE MATCH & FREE RETURNS

WE WILL PRICE MATCH ANY RETAIL COMPETITOR ON THE SAME EXACT AVAILABLE BRAND AND MODEL PART.

(THE ITEM MUST BE IDENTICAL, INCLUDING PRODUCT MANUFACTURER OR ORIGIN.)

GROUND UP KNOWS THAT THINGS HAPPEN. THIS IS WHY WE ARE THE LEADER IN OUR INDUSTRY! IF FOR ANY REASON, AT ANY TIME, YOU NEED TO RETURN AN UNUSED, UNINSTALLED OR UNMODIFIED PART, SIMPLY CALL OR EMAIL FOR YOUR RMA NUMBER. THAT'S IT! YOU CAN THEN SHIP YOUR PART OR PARTS BACK FOR A CREDIT OR REFUND. ALL WE ASK IS THAT THE PART IS IN ITS ORIGINAL CONDITION.

KEEP A LOOK OUT FOR THESE LOGOS BELOW THROUGHOUT THE CATALOG FOR BIG SAVINGS AND DISCOUNTS ON KITS!



- TABLE OF CONTENTS -

INTERIOR PARTS & TRIM 2-53	EXTERIOR PARTS & TRIM 157-173
STEREO & SPEAKERS..... 54-56	SHEETMETAL & RELATED 174-189
CONVERTIBLE TOP 57-59	GLASS 190-193
TRUNK..... 60	WEATHERSTRIP..... 194-196
WHEELS & TIRES 61-64	ELECTRICAL 197-204
BRAKES 65-74	LIGHTING 205-211
STEERING & SUSPENSION 75-93	LOCKS 212-213
TRANSMISSION 94-105	EMBLEMS 214-216
FUEL & EXHAUST 106-112	STENCILS & STRIPES 217-219
HEATING & COOLING 113-118	DECALS & PAINT 220-222
ENGINE PARTS 119-140	BOOKS & MANUALS 223
ENGINE COMPARTMENT 141-149	INDEX 224-228
HARDWARE 150-156	ORDER FORMS & POLICIES 229-232



Ground Up Junior Interior Kits

These interior kits are a great way to freshen up your ride! Ground Up junior kits include all of the basic items needed to spruce up your interior. These kits feature "out of the box" pre-assembled door panels from PUI. This means that they are ready to install with moldings and window felts where applicable. Our seat covers are also crafted by PUI and feature all of the correct grains, materials and colors as original. We finish off these kits with complete PUI headliner and side sail kits which feature OEM grains and colors and a brand new ACC carpet which duplicates OEM style carpets. You will not find a higher quality interior kit on the market!

1967-69 Junior Interior Kit for Standard Coupe

Contains the following items:

- Front Seat Cover Set
- Rear Seat Cover Set
- Front "Out of the Box" Door Panel Set
- Rear "Out of the Box" Door Panel Set
- Carpet Set with Jute
- Headliner Set with Side Sails

JIKIT-67C	1967 Black	MSRP 709.70	669.55 kit
JIKIT-68C	1968 Black	MSRP 809.70	766.75 kit
JIKIT-69C	1969 Black	MSRP 809.70	766.75 kit

1967-69 Junior Interior Kit for Standard Convertible

Contains the following items:

- Front Seat Cover Set
- Rear Seat Cover Set
- Front "Out of the Box" Door Panel Set
- Rear "Out of the Box" Door Panel Set
- Carpet Set with Jute
- Rear Arm / Piston Cover Set

JIKIT-67CV	1967 Black	MSRP 636.70	598.45 kit
JIKIT-68CV	1968 Black	MSRP 776.70	728.95 kit
JIKIT-69CV	1969 Black	MSRP 776.70	726.25 kit

Super Interior Kits

Our Super Interior Kit is a no brainer! This kit is perfect when most of your interior is wrecked or missing! All of our kits feature "out of the box" PUI door panels and PUI seat covers.

1967-69 Super Interior Kit for Standard Coupe

Contains the following items:

- PUI Front Seat Cover Set
- PUI Rear Seat Cover Set
- Plastic Seat Backs
- PUI Front "Out of the Box" Door Panel Set
- PUI Rear "Out of the Box" Door Panel Set
- Front Arm Rest Bases
- Front Arm Rest Pads
- Door Lock Knobs
- ACC Carpet Set with Jute
- Carpet Sound Deadener
- 2 Door Sill Plates
- PUI Headliner with Side Sails
- Dome Light Lens
- Dome Light Bezel
- Rear Deck Package Tray
- Package Tray Insulation
- Trunk Divider Board
- Trunk Divider Insulation

SUKIT-67F	1967 Black	MSRP 1018.85	909.13 kit
SUKIT-68F	1968 Black	MSRP 1119.90	1000.03 kit
SUKIT-69F	1969 Black	MSRP 1119.90	1000.03 kit

1967-69 Super Interior Kit for Standard Convertible

Contains the following items:

- PUI Front Seat Cover Set
- PUI Rear Seat Cover Set
- Plastic Seat Backs
- PUI Front "Out of the Box" Door Panel Set
- PUI Rear "Out of the Box" Door Panel Set
- Front Arm Rest Bases
- Front Arm Rest Pads
- Rear Arm Rest/Piston Covers
- Vinyl Sunvisors
- Door Lock Knobs
- ACC Carpet Set with Jute
- Carpet Sound Deadener
- 2 Door Sill Plates
- Trunk Divider Board
- Trunk Divider Insulation

SUKIT-67FV	1967 Black	MSRP 989.05	879.42 kit
SUKIT-68FV	1968 Black	MSRP 1131.05	1066.98 kit
SUKIT-69FV	1969 Black	MSRP 1137.05	1005.15 kit

Interior kits are available in black only. Colors are special order. Please call. No Volume Discount. All interior kits ship in multiple Oversize boxes.

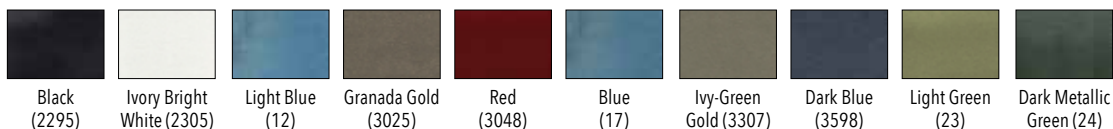



BUY 'N SAVE WITH KITS

IAS-F69S



PUI Pre-Assembled Standard Seats

If you're thinking about having your standard bucket seats re-upholstered, consider these pre-assembled standard bucket seat assemblies instead! These assemblies are COMPLETE with frames, tracks and side covers that are covered in PUI upholstery. These assemblies cost much less than buying all of the separate components and paying an interior shop to put it all together. Simply take them out of the box and bolt them in and you're ready to go!

IAS-F67S	1967-68 Standard.....	1696.99 pr.
IAS-F69S	1969 Standard.....	1712.99 pr.

Headrests are not included but can be added.

Please state color at time of order. All seats ship in two Oversize 2 boxes.

PUI Standard Seat Cover Kits

Replace your front and rear seat covers all in one shot and save with this specially priced PUI seat cover kit! Each kit includes one set of front PUI front bucket seat covers and a set of rear PUI seat covers to get your interior looking showroom fresh.

IUP-671K	1967-68 Coupe.....	187.18 kit
IUP-671VK	1967-68 Convertible.....	187.18 kit
IUP-69K	1969 Coupe.....	187.18 kit
IUP-69VK	1969 Convertible.....	184.48 kit
IUP-70FK	1970 All.....	414.88 kit
IUP-71FK	1971-73 All.....	421.18 kit
IUP-74FK	1974-76 All.....	431.08 kit
IUP-77FK	1977 All.....	409.48 kit
IUP-78FK	1978-79 All.....	421.18 kit
IUP-80FK	1980-81 Vinyl.....	427.48 kit

Black only. All seat covers ship Oversize.

PUI Standard Seat Covers

These PUI seat covers are constructed of the finest quality materials available. These seat covers are perfect for most cars out there whether they are daily drivers or trailer queens.



IUP-671

1967-68 Standard Vinyl

Madrid grain vinyl with dielectrically sealed vertical pleats.

IUP-671	1967-68 Front Buckets Black.....	103.99 pr.
IUP-67FS_U	1967-68 Front Buckets Colors.....	135.99 pr.
IUP-67FS10B	1967-68 Front Bench.....	159.99 pr.
IUP-672	1967-68 Coupe Rear Black.....	103.99 pr.
IUP-67FS_C	1967-68 Coupe Rear Colors.....	121.99 pr.
IUP-672V	1967-68 Convertible Rear Black.....	103.99 pr.
IUP-67FS_V	1967-68 Convert Rear Colors.....	124.99 pr.
IUP-67FS_F	1967 Fold Down Rear.....	121.99 pr.
IUP-68FS_F	1968 Fold Down Rear.....	121.99 pr.

Available in: 1967-68 Black (10), 1967-68 White (37), 1967 Light Blue (12), 1967 Gold (43), 1967-68 Red (30), 1968 Blue (17) and 1968 Ivy Gold (46)



IUP-691

1969 Standard Vinyl

Madrid grain vinyl with dielectrically sealed horizontal pleats.

IUP-691	1969 Front Buckets Black.....	103.99 pr.
IUP-69FS_U	1969 Front Buckets Colors.....	121.99 pr.
IUP-692	1969 Coupe Rear Black.....	103.99 pr.
IUP-69FS_C	1969 Coupe Rear Colors.....	121.99 pr.
IUP-692V	1969 Convertible Rear Black.....	100.99 pr.
IUP-69FS_V	1969 Convertible Rear Colors.....	121.99 pr.
IUP-69FS_F	1969 Fold Down Rear.....	118.99 pr.

Available in: Black (10), Dark Blue (16), Light Green (23), Dark Metallic Green (24), Red (30) and White (37)



IUP-1027

1970 Standard Vinyl

Madrid grain vinyl with Laredo grain vinyl inserts and dielectrically sealed vertical pleats.

IUP-1027	Front Buckets Black.....	262.99 pr.
IUP-1032	Rear Black.....	197.99 pr.
IUP-70FS_U	1970 Standard Buckets Colors.....	262.99 pr.
IUP-70FS_C	1970 Rear Colors.....	191.99 pr.

Available in: Black (10), Bright Blue (14), Dark Metallic Green (24), Saddle (36) and Sandalwood (41)





IUP-711

1971-73 Standard Vinyl

Madrid grain vinyl with Elk grain vinyl inserts and sewn inserts. Buttons are included.

IUP-711	Black Front Buckets.....	311.99 pr.
IUP-732	Black Rear.....	155.99 pr.
IUP-71FS_U	Buckets.....	312.99 pr.
IUP-71FS_C	Rear.....	151.99 pr.

Available in: 1971-73 Black (10), 1971-72 Blue (09), 1971 Jade Green (19), 1971 Sandalwood (41), 1971 Dark Blue (16), 1971, 1973 Dark Saddle (42), 1972-73 Dark Green (25), 1972-73 Covert (29), 1972 White (37) and 1972 Tan (47)

1974-76 Standard Vinyl

Madrid grain vinyl with Elk grain vinyl inserts and sewn inserts. Buttons are included.

IUP-74FS_U	Front Buckets.....	312.99 pr.
IUP-74FS_C	Rear.....	151.99 pr.

Available in: 1974-76 Black (10), 1974 Bright Red (32), 1974 Light Saddle (35), 1975-76 White (37), 1975 Sandalwood (41), 1975 Dark Saddle (42), 1976 Firethorn (45) and 1976 Saddle (36)

1977 Standard Vinyl

Sierra grain vinyl with Elk grain vinyl inserts and sewn inserts. Buttons are included.

IUP-77FS_U	Front Buckets.....	302.99 pr.
IUP-77FS_C	Rear.....	151.99 pr.

Available in: Black (70), Saddle (36), White (37), Camel (48) and Firethorn (45)

1978-79 Standard Vinyl

Sierra grain vinyl with Elk grain vinyl inserts and sewn inserts with zipper on back. Buttons are included.

IUP-78FS_U	Front Buckets.....	311.99 pr.
IUP-78FS_C	Rear.....	155.99 pr.

Available in: 1978-79 Black (70), 1978 White (37), 1978-79 Carmine (38), 1978-79 Camel (48) and 1979 Light Blue (90)

1980-81 Standard Vinyl

Sierra grain vinyl with Elk grain vinyl inserts and sewn inserts with zipper on back and smooth headrest area. Buttons are included.

IUP-80FS_U	Front Buckets.....	322.99 pr.
IUP-80FS_C	Rear.....	151.99 pr.

Available in: Black (70), Navy Blue (18), Light Saddle (35), Carmine (38), Camel (48), Silver (66), Bright Red (77), Oyster (86) and White (37)

IAS-F67D

PUI Pre-Assembled Deluxe Seats

If you're thinking about having your deluxe bucket seats re-upholstered or converting from standard to deluxe interior, consider these pre-assembled DLX bucket seat assemblies instead! These assemblies are COMPLETE with frames, tracks and side covers. These assemblies cost much less than buying all of the separate components and paying an interior shop to put it all together. Simply take them out of the box and bolt them in and you're ready to go!

IAS-F67D_	1967 Deluxe.....	1696.99 pr.
IAS-F68D_	1968 Deluxe.....	1878.99 pr.
IAS-F69D	1969 Deluxe.....	1739.95 pr.
IAS-F68H	1968 Houndstooth.....	1918.99 pr.
IAS-F69H	1969 Houndstooth.....	1898.99 pr.

Head rests are not included. Side covers are currently only available in black and can be painted to match. Please state color at time of order. All seats ship in two Oversize 2 boxes. No volume discount.



IUP-71FSC10U

1971-77 Standard Cloth

Replacement style covers are just like the original standard vinyl seats but feature Madrid grain vinyl sides with full Empress cloth seat facings. The result is a very comfortable seat which still has that original muscle car look!

IUP-71FSC_U	Front Buckets.....	323.99 pr.
IUP-71FSC_C	Rear.....	280.99 pr.

Available in: Black (10), Light Blue (12), Dark Blue/Navy (18), Dark Red (30), Buckskin (36) and Camel (48)



IUP-80FSC10U

1980 Standard Cloth

Sierra grain vinyl with Empress cloth inserts and sewn inserts with vertical pleats and zipper on back.

IUP-80FSC_U	Front Buckets.....	311.99 pr.
IUP-80FSC_C	Rear.....	207.99 pr.

Available in: Black (70), Dark Blue (18) and Camel (48)

1981 Standard Cloth

Sierra grain vinyl with Millport cloth inserts and sewn inserts with vertical pleats and zipper on back.

IUP-81FSC_U	Front Buckets.....	314.99 pr.
IUP-81FSC_C	Rear.....	211.99 pr.

Available in: Charcoal (70), Dark Blue (18) and Camel (48)



**See Page 11 For
Seat Foams
& Springs**



Note: Due to variations in printing, it is impossible to perfectly represent upholstery colors in this catalog. Use our color swatch chart as a guide only. We will gladly mail you a color sample before you place your order upon request. Please note that colors other than black are non-returnable.



1967 Deluxe Vinyl

Madrid grain vinyl with dielectrically sealed inserts featuring horizontal stitchband pleats and contrasting accent band border.

IUP-675	Front Buckets.....	270.99 pr.
IUP-675B	Front Bench w/ Arm Rest.....	246.99 pr.
IUP-677	Stationary Coupe/Convertible.....	152.99 pr.
IUP-677F	Fold Down Rear.....	146.99 pr.

Available in: Black/White, Aqua/Dark Aqua, Bright Blue/White, Red/Black, Off White/Black and Gold/White



1968 Deluxe Comfortweave

Madrid grain vinyl with dielectrically sealed horizontal pleats.

IUP-685	Front Buckets.....	292.99 pr.
IUP-685B	Front Bench w/ Arm Rest.....	292.99 pr.
IUP-686	Coupe Rear.....	171.99 pr.
IUP-686V	Convertible Rear.....	171.99 pr.
IUP-686F	Fold Down Rear.....	171.99 pr.

Available in: Black, Aqua, 68 Blue, Pearl, Red and Ivy Gold



1968 Deluxe Houndstooth

Madrid grain vinyl with Houndstooth cloth inserts and sewn horizontal pleats.

IUP-068	Front Buckets.....	384.99 pr.
IUP-168	Coupe Rear.....	239.99 pr.
IUP-168V	Convertible Rear.....	232.99 pr.
IUP-168F	Fold Down Rear.....	232.99 pr.

Available in: Black, White and Pearl



1968 Deluxe Seat Emblems

Correct with mounting tabs to be folded as original. The retainers allow for the correct recessed look. Does two buckets. ISE-68DX 1968 Deluxe92.99 kit



1969 Deluxe Comfortweave

Madrid grain vinyl with simulated Comfortweave inserts and sewn vertical pleats. Buttons are included.

IUP-695	Front Buckets.....	291.99 pr.
IUP-696	Coupe Rear.....	207.99 pr.
IUP-696V	Convertible Rear.....	201.99 pr.
IUP-696F	Fold Down Rear.....	201.99 pr.

Available in: Black, Dark Blue, Light Green, Dark Metallic Green and Red



1969 Deluxe Houndstooth

Madrid grain vinyl with Houndstooth cloth inserts and sewn vertical pleats. Buttons are included.

IUP-169	Front Buckets.....	363.99 pr.
IUP-269	Coupe Rear.....	207.99 pr.
IUP-269V	Convertible Rear.....	201.99 pr.
IUP-269F	Fold Down Rear.....	201.99 pr.

Available in: Black with White Houndstooth, Orange with Black Houndstooth and White with Black Houndstooth



PUI Deluxe & Houndstooth Seat Cover Kits

Replace your front and rear seat covers all in one shot and save with this specially priced PUI seat cover kit! Each kit includes one set of front PUI bucket seat covers and a set of rear PUI seat covers to get your interior looking showroom fresh.

IUP-675K	1967 Coupe Deluxe.....	381.58 kit
IUP-675VK	1967 Convertible Deluxe.....	381.58 kit
IUP-685K	1968 Coupe Deluxe.....	418.48 kit
IUP-685VK	1968 Convertible Deluxe.....	418.48 kit
IUP-068K	1968 Coupe Houndstooth.....	562.48 kit
IUP-068VK	1968 Convertible Houndstooth.....	556.18 kit
IUP-695K	1969 Coupe Deluxe.....	449.98 kit
IUP-695VK	1969 Convertible Deluxe.....	444.58 kit
IUP-169K	1969 Coupe Houndstooth.....	514.78 kit
IUP-169VK	1969 Convertible Houndstooth.....	509.38 kit
IUP-701K	1970 Coupe Deluxe.....	468.88 kit

Please state color at time of order. All seat covers ship Oversize. No volume discount.



1970 Deluxe Comfortweave

Madrid grain vinyl with simulated Comfortweave inserts and sewn vertical pleats with horizontal trim strips.

IUP-701	Front Buckets.....	291.99 pr.
IUP-702	Rear.....	228.99 pr.

Available in: Black, Bright Blue, Dark Metallic Green, Sandalwood and Saddle



1970 Checkerboard Cloth

Madrid grain vinyl with Checkerboard cloth inserts and double stitched vertical pleats with horizontal trim strips.

IUP-70DSC10U	Front Buckets.....	373.99 pr.
IUP-70DSC10C	Rear.....	282.99 pr.

Available in: Black



1971 Checkerboard Cloth

Madrid grain vinyl with Checkerboard cloth inserts and sewn vertical pleats with horizontal trim strips. Buttons are included.

IUP-71DSC10U	Front Buckets.....	373.99 pr.
IUP-71DSC10C	Rear.....	282.99 pr.

Available in: Black



1973 LT

Madrid grain vinyl with simulated Comfortweave inserts and sewn vertical pleats. Buttons are included.

IUP-3LTF	Front Buckets.....	291.99 pr.
IUP-3LTR	Rear.....	232.99 pr.

Available in: Black and Sandalwood



- OEM Colors
- OEM Materials



1976 LT Custom Cloth

Madrid grain vinyl with Empress cloth seat facing and sewn grid with horizontal and vertical lines.

IUP-76DSC10U Front Buckets..... 321.99 pr.
IUP-76DSC10C Rear..... 201.99 pr.

Available in: Black and Red



1977 LT Custom Vinyl

Sierra grain vinyl with Plisse grain inserts and sewn grid with horizontal and vertical lines.

IUP-77DS70U Front Buckets..... 302.99 pr.
IUP-77DS70C Rear..... 196.99 pr.

Available in: Black, Buckskin, White and Light Blue



1977-78 LT Custom Cloth

Sierra grain vinyl with Empress cloth inserts and sewn grid with horizontal and vertical lines.

IUP-77DSC70U Front Buckets..... 302.99 pr.
IUP-77DSC70C Rear..... 196.99 pr.

Available in: Black, Buckskin, Carmine, Firethorn, Camel and Light Blue



1978 LT Custom Vinyl

Sierra grain vinyl inserts with Rattan grain inserts and sewn grid with horizontal and vertical lines with zipper on back.

IUP-78DS70U Front Buckets..... 302.99 pr.
IUP-78DS70C Rear..... 196.99 pr.

Available in: Black, White, Carmine and Camel



1979 Berlinetta Custom Vinyl

Sierra grain vinyl with Rattan vinyl inserts and zipper on back.

IUP-79DS70U Front Buckets..... 312.99 pr.
IUP-79DS70C Rear..... 191.99 pr.

Available in: Black, Carmine, Camel and Light Blue

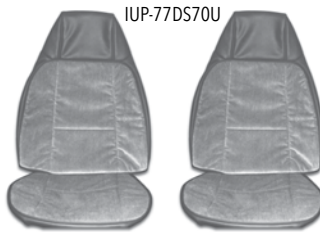

1979 Berlinetta Custom Cloth

Sierra grain vinyl with Empress cloth inserts and zipper on back.

IUP-79DSC70U Front Buckets..... 312.99 pr.
IUP-79DSC70C Rear..... 191.99 pr.

Available in: Black, Carmine, Camel and Light Blue



1980-81 Berlinetta Custom Vinyl

Sierra grain vinyl with Derma grain vinyl inserts and zipper on back.

IUP-80DS70U Front Buckets..... 343.99 pr.
IUP-80DS70C Rear..... 197.99 pr.

Available in: Black, Navy, Carmine, Camel, Silver, Bright Red and Oyster

1980-81 Berlinetta Custom Cloth

Sierra grain vinyl with Derma grain vinyl inserts and zipper on back.

IUP-80DSC70U Front Buckets..... 343.99 pr.
IUP-80DSC70C Rear..... 259.95 pr.

Available in: Black, Navy, Carmine, Camel, Silver, Bright Red and Oyster

1982-83 Berlinetta Custom

IUP-82DSC__U 1982-83 Berlinetta/Custom..... 298.99 pr.
IUP-82DSC__C 1982-83 Berlinetta/Custom Rear..... 250.99 pr.

02 = Lt Gray, 03 = Dk Blue



1982-85 Standard Vinyl

IUP-82FS__U 1982-85 Standard Buckets 200.99 pr.
IUP-82FS__C 1982-85 Standard Rear..... 200.99 pr.
70 = Black, 18 = Dk. Blue, 48 = Camel, 38 = Red



1982-85 Cloth

IUP-82FSC__U 1982-85 Cloth Bucket..... 298.99 pr.
IUP-82FSC__C 1982-85 Cloth Rear..... 200.99 pr.
01 = Maroon, 18 = Blue, 48 = Camel, 38 = Red, 70 = Charcoal, 02 = Gray, 10 = Black



1982-88 Indy 500 Pace Car

IUP-82D SPL66U 1982 Pace Car Buckets Leather . 1106.95 pr.
IUP-82D SPV66U 1982 Pace Car Buckets Vinyl..... 624.99 pr.
IUP-84DSC__U 1984-86 Z/28 Deluxe..... 440.99 pr.
36 = Camel, 02 = Gray, 38 = Red
IUP-84DSC__C 1984-86 Custom Rear..... 348.99 pr.
02 = Gray, 38 = Red, 36 = Camel
IUP-84DSC__CA 1984-86 Rear Split Back 324.95 pr.
36 = Camel, 02 = Gray, 38 = Red
IUP-88DSC__U 1988-92 Deluxe Cloth 460.99 pr.
38 = Red, 02 = Gray
IUP-88DSC__C 1988-92 Rear Fold Down 348.99 pr.
02 = Gray, 38 = Red



1967-1969 TMI Sport Seat Upholstery

TMI Sport Seats are the best way to upgrade your stock seats without having to sacrifice your original interiors style and appearance. TMI

Sports Seats attach directly to your existing stock frames, utilizing the factory attachment methods. The result is a heavily bolstered seat that is stock in appearance but much more supportive and comfortable than the original. *Note: Sport Seat Upholstery must be purchased in conjunction with Sport Seat Foam. Sport Seat Upholstery will NOT fit over your stock foams. Rear Upholstery is stock and will fit over your stock foams.*



1967-68 Standard Interior

TMI-S2CAS678-0105	Front & Rear Kit Coupe	340.99 kit
TMI-S2CAS678-0094	Front & Rear Kit Coupe w/ Fold Down.....	340.99 kit
TMI-S2CAS678-0083	Front & Rear Kit Convertible.....	340.99 kit
TMI-S2CAS678-0116	Front Buckets Only.....	243.99 pr.

Call for color options or visit us @ SS396.COM



1967 Deluxe Interior

TMI-S2CAD67-0004	Front & Rear Kit Coupe	531.99 kit
TMI-S2CAD67-0010	Front & Rear Kit Coupe w/ Fold Down.....	531.99 kit
TMI-S2CAD67-0001	Front & Rear Kit Convertible.....	531.99 kit
TMI-S2CAD67-0007	Front Buckets Only	391.99 pr.

Call for color options or visit us @ SS396.COM



1968 Deluxe Interior

TMI-S2CAD68-0021	Front & Rear Kit Coupe	531.99 kit
TMI-S2CAD68-0033	Front & Rear Kit Coupe w/ Fold Down.....	531.99 kit
TMI-S2CAD68-0013	Front & Rear Kit Convertible	531.99 kit
TMI-S2CAD68-0027	Front Buckets Only.....	391.99 pr.

Call for color options or visit us @ SS396.COM



1968 Deluxe Houndstooth Interior

TMI-S2CAD68-0041	Front & Rear Kit Coupe	828.99 kit
TMI-S2CAD68-0039	Front & Rear Kit Coupe w/ Fold Down.....	828.99 kit
TMI-S2CAD68-0019	Front & Rear Kit Convertible	828.99 kit
TMI-S2CAD68-0043	Front Buckets Only.....	522.99 pr.

Call for color options or visit us @ SS396.COM



1969 Standard Interior

TMI-S2CAS69-0139	Front & Rear Kit Coupe.....	340.99 kit
TMI-S2CAS69-0133	Front & Rear Kit Coupe w/ Fold Down.....	340.99 kit
TMI-S2CAS69-0127	Front & Rear Kit Convertible.....	340.99 kit
TMI-S2CAS69-0145	Front Buckets Only.....	243.99 pr.

Call for color options or visit us @ SS396.COM



1969 Deluxe Comfortweave Interior

TMI-S2CAD69-0054	Front & Rear Kit Coupe.....	698.99 kit
TMI-S2CAD69-0067	Front & Rear Kit Coupe w/ Fold Down	698.99 kit
TMI-S2CAD69-0045	Front & Rear Kit Convertible.....	698.99 kit
TMI-S2CAD69-0060	Front Buckets Only.....	344.99 pr.

Call for color options or visit us @ SS396.COM



1969 Deluxe Houndstooth Interior

TMI-S2CAD69-0077	Front & Rear Kit Coupe.....	828.99 kit
TMI-S2CAD69-0074	Front & Rear Kit Coupe w/ Fold Down	828.99 kit
TMI-S2CAD69-0051	Front & Rear Kit Convertible.....	828.99 kit
TMI-S2CAD69-0080	Front Buckets Only.....	522.99 pr.

Call for color options or visit us @ SS396.COM



1967-1969 TMI Sport R Seat Upholstery

TMI's new Sport R Seats for the Camaro hold on to the iconic styling cues that make a Camaro interior so easily recognizable. However, these new

Sport R Series seats do a great job of modernizing the originals by adding a french seam stitched in a contrasting thread color around the perimeter of the seats and by accenting the insert sections of the seats with a matching black unisuede. *Note: Sport R Seat Upholstery must be purchased in conjunction with bucket seat Sport Seat Foam - front bucket Sport Seat Upholstery will NOT fit over your stock bucket foams. You can use your stock foam for the rear covers.*



1967-68 Standard Interior

TMI-SRCA678-0001	Front & Rear Kit Coupe.....	555.95 kit
TMI-SRCA678-0005	Front & Rear Kit Coupe w/ Fold Down	555.95 kit
TMI-SRCA678-0009	Front & Rear Kit Convertible.....	555.95 kit
TMI-SRCA678-0013	Front Buckets Only.....	400.95 pr.

Call for color options or visit us @ SS396.COM



1967 Deluxe Interior

TMI-SRCA67-0033	Front & Rear Kit Coupe.....	685.95 kit
TMI-SRCA67-0037	Front & Rear Kit Coupe w/ Fold Down	685.95 kit
TMI-SRCA67-0041	Front & Rear Kit Convertible.....	685.95 kit
TMI-SRCA67-0045	Front Buckets Only	462.95 pr.

Call for color options or visit us @ SS396.COM



1968 Deluxe Interior

TMI-SRCA68-0049	Front & Rear Kit Coupe.....	685.95 kit
TMI-SRCA68-0053	Front & Rear Kit Coupe w/ Fold Down	685.95 kit
TMI-SRCA68-0057	Front & Rear Kit Convertible.....	685.95 kit
TMI-SRCA68-0061	Front Buckets Only.....	462.95 pr.

Call for color options or visit us @ SS396.COM



1968 Deluxe Houndstooth Interior

TMI-SRCA68-0065	Front & Rear Kit Coupe.....	923.95 kit
TMI-SRCA68-0069	Front & Rear Kit Coupe w/ Fold Down	923.95 kit
TMI-SRCA68-0073	Front & Rear Kit Convertible.....	923.95 kit
TMI-SRCA68-0077	Front Buckets Only.....	581.95 pr.

Call for color options or visit us @ SS396.COM



1969 Standard Interior

TMI-SRCA69-0017	Front & Rear Kit Coupe.....	555.95 kit
TMI-SRCA69-0021	Front & Rear Kit Coupe w/ Fold Down	555.95 kit
TMI-SRCA69-0025	Front & Rear Kit Convertible.....	555.95 kit
TMI-SRCA69-0029	Front Buckets Only.....	416.95 pr.

Call for color options or visit us @ SS396.COM



1969 Deluxe Comfortweave Interior

TMI-SRCA69-0097	Front & Rear Kit Coupe.....	800.95 kit
TMI-SRCA69-0101	Front & Rear Kit Coupe w/ Fold Down	800.95 kit
TMI-SRCA69-0105	Front & Rear Kit Convertible.....	800.95 kit
TMI-SRCA69-0109	Front Buckets Only.....	479.95 pr.

Call for color options or visit us @ SS396.COM



1969 Deluxe Houndstooth Interior

TMI-SRCA69-0081	Front & Rear Kit Coupe.....	923.95 kit
TMI-SRCA69-0085	Front & Rear Kit Coupe w/ Fold Down	923.95 kit
TMI-SRCA69-0089	Front & Rear Kit Convertible.....	897.95 kit
TMI-SRCA69-0093	Front Buckets Only.....	581.95 pr.

Call for color options or visit us @ SS396.COM



TMI Sport, Sport R & Sport XR Seat Foam

This TMI seat foam is made to work with your new TMI Sport Seat covers. This foam is bolstered providing modern car comfort and extra support. Made in the USA.

43-8079



43-8067	1967-68 Standard.....	153.99 ea.
43-8069	1969 Standard.....	153.99 ea.
43-8077	1967 Deluxe.....	153.99 ea.
43-8078	1968 Deluxe, Houndstooth	153.99 ea.
43-8079	1969 Deluxe, Houndstooth	153.99 ea.

Note: Stock seat covers will NOT cover this TMI Sport Seat foam.

No Volume Discount. Ships Oversize.



TMI Pro Series Seat Mounting Brackets

TMI's new Pro-Series seats require these custom fit seat brackets for a correct fit.

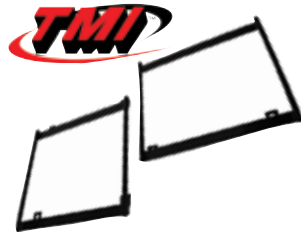

47-5050	1967-69	213.99 pr.
47-5051	1970-74	213.99 pr.
47-5052	1975-81	213.99 pr.

** These come as a pair for two seats.*

These brackets only work with TMI Seats.

Colors other than black are available for an additional fee. Please call for color options or visit us @ SS396.COM! TMI Seats Ship Oversize 2. No Volume Discount.



SEAT BELTS



Original Style Retractable Seat Belts

OE style belts feature a correct fit and function like your factory originals. These belts feature the correct front retractors and GM logo like originals. Also available for the first time; correct factory shoulder harness belts. Made in the USA

SBL-6769-1000	1967-69 Front Lap Belts GM Buckle	210.99 set
SBL-6769FR1000	1967-69 Front & Rear Lap Belts GM Buckle	315.99 set
SBL-6769KIT1000	1967-69 Front & Rear Lap Belts w/ Shoulder Harness	436.99 set
SBL-6769SH1000	1967-69 Front Shoulder Harnesses	155.99 set



Shown with GM logo buckles.

1967-73 3 Point Front Seat Belts

Add comfort and safety to your muscle car while still keeping a stock look with Ground Up's 3 point retractable seat belts! These three point belts feature a vintage style lap belt and chest belt so you can have new car safety with old car looks. Each kit includes two seat belts, grade 8 mounting hardware and powdercoated mounting brackets all assembled and ready to bolt in to your Camaro. Instructions are also included. These seat belts mount in the factory locations, meaning there is no drilling required. Seat belts meet FMVSS standards. Fill blank with your color choice.*

Front 3 Point Seat Belt Conversion

SBL-67CA3F_	1967-69 Front w/ Starburst Logo	326.99 kit
SBL-67CA3FGM_	1967-69 Front w/ GM Logo	365.99 kit
SBL-70CA3F_	1970-73 Front w/ Starburst Logo	326.99 kit

Black = 1000	Dark Brown = 3005	Turquoise = 4009	White = 9000
Flame Red = 2006	Med Beige = 3008	Military Green = 5002	Silver = 6007
Red = 2007	Desert Tan = 3009	Lime Green = 5004	Gray = 6005
Red Wine = 2009	Electric Blue = 4000	Dark Green = 5006	Dark Blue = 4004
Purple = 2010	Blue = 4002	Charcoal = 6009	Ivory = 8008
Tan = 3000	Powder Blue = 4005	Orange = 7001	
Brown = 3004	Cobalt Blue = 4006	Yellow = 7500	

*Colors are special order and are non-returnable. See ss396.com for color swatches. Not all colors available for all styles. Ask your sales rep for color availability.

IK-320



1967-69 Standard Seat Belts

OE style reproduction lap belts with correct high grade, blow formed ABS housings, web designed belt with correct patterned stitching and correct seat belt retractor/roller assembly.

IK-319	1967-69 Standard Front	159.99 ea.
IK-320	1967-69 Standard Rear	49.99 ea.
IR-173	1967-69 Standard Set 2 Front/Rear	692.96 kit

No volume discount.

IK-316



1967 Deluxe Seat Belts

OE style reproduction lap belts with correct retractor, seat belt and buckle assembly with Fisher coach emblem.

IK-316	1967 Deluxe Front	159.99 ea.
IK-316R	1967 Deluxe Rear	159.99 ea.
IR-172	1967 Deluxe Set 2 Front/3 Rear	719.96 kit

No volume discount.

IK-315



1968-69 Deluxe Seat Belts

OE style reproduction seat belts with correct retractor, seat belt and buckle assembly with GM emblem.

IK-315	1968-69 Deluxe Front	159.99 ea.
IK-315R	1968-69 Deluxe Rear	49.99 ea.
IR-171	1968-69 Deluxe Set 2 Front/3 Rear	665.96 kit

No volume discount.



1974-81 Seat Belt Set

This is a set of factory style seat belts. This four person seat belt set has been assembled with factory three panel webbing with retractors and factory buckles. Perfect for restoring your interior!

ISB-781BK	1974-81 Black	399.95 kit
ISB-781TN	1974-81 Tan	399.95 kit
ISB-781SL	1974-81 Silver	399.95 kit
ISB-781RD	1974-81 Red	399.95 kit
ISB-781BB	1974-81 Bright Blue	399.95 kit
ISB-781MR	1974-81 Maroon	399.95 kit
ISB-781NB	1974-81 Navy Blue	399.95 kit

No volume discount.



Standard Style GM Logo Seat Belts

OE style reproduction seat belt set featuring correct retractor, seat belt and buckle assembly with GM emblem.

Front Sets Lap

SBL-CAM67692007S	1967-69 Red	260.99 pr.
SBL-CAM67694002S	1967-69 Blue.....	260.99 pr.
SBL-CAM67695002S	1967-69 Green.....	260.99 pr.

Front & Rear Sets Lap

SBL-CAM6769FR1000S	1967-69 Black.....	365.46 kit
SBL-CAM6769FR2007S	1967-69 Red	359.99 kit
SBL-CAM6769FR4002S	1967-69 Blue.....	359.99 kit
SBL-CAM6769FR5002S	1967-69 Green.....	359.99 kit.

Front & Rear Sets Lap & Shoulder

SBL-CAM6769KIT1000S	1967-69 Black.....	524.99 kit
SBL-CAM6769KIT2007S	1967-69 Red	524.99 kit
SBL-CAM6769KIT4002S	1967-69 Blue.....	524.99 kit
SBL-CAM6769KIT5002S	1967-69 Green.....	524.99 kit

Front Shoulder Sets

SBL-CAM6769SH2007S	1967-69 Red	180.99 pr.
SBL-CAM6769SH4002S	1967-69 Blue.....	180.99 pr.
SBL-CAM6769SH5002S	1967-69 Green.....	180.99 pr.

No volume discount.



Deluxe Style GM Logo Seat Belts

OE style reproduction seat belt set featuring correct retractor, seat belt, and buckle assembly with GM emblem.

Front Sets Lap

SBL-CAM67692007P	1967-69 Red.....	275.99 pr.
SBL-CAM67694002P	1967-69 Blue	275.99 pr.
SBL-CAM67695002P	1967-69 Green.....	275.99 pr.

Front & Rear Sets Lap

SBL-CAM6769FR1000P	1967-69 Black	365.46 kit
SBL-CAM6769FR2007P	1967-69 Red.....	374.99 kit
SBL-CAM6769FR4002P	1967-69 Blue	374.99 kit
SBL-CAM6769FR5002P	1967-69 Green.....	374.99 kit

Front & Rear Sets Lap & Shoulder

SBL-CAM6769KIT1000P	1967-69 Black	539.99 kit
SBL-CAM6769KIT2007P	1967-69 Red.....	539.99 kit
SBL-CAM6769KIT4002P	1967-69 Blue	539.99 kit
SBL-CAM6769KIT5002P	1967-69 Green.....	539.99 kit

Front Shoulder Sets

SBL-CAM6769SH2007P	1967-69 Red.....	195.99 pr.
SBL-CAM6769SH4002P	1967-69 Blue	195.99 pr.
SBL-CAM6769SH5002P	1967-69 Green.....	195.99 pr.

No volume discount.

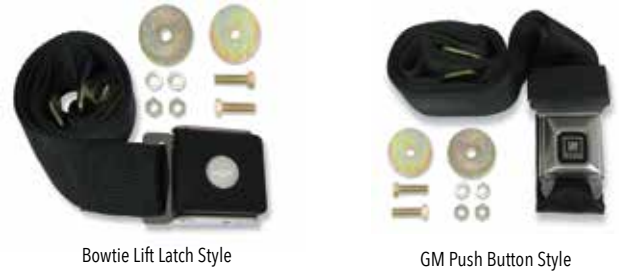

Bowtie Lift Latch Style

GM Push Button Style



Chrome Lift Latch Style



GM Plastic Push Button Style

Starburst Push Button Style

Vintage Style Seat Belts

Now you can have the styling of muscle-era GM seat belts without the high price! Choose from plain chrome lift latch style belts, Starburst push button style belts, Bowtie logo lift latch belts or GM push button style belts. Any of these belts will look right at home in your muscle car. Perfect for daily drivers, weekend warriors, pro touring, pro street or any other muscle car! Available individually or as a complete 4 piece kit! Hardware is included with all vintage style seat belts. Fill blank with your color choice.*

SBL-1800-____-74	Chrome Lift Latch Style 74".....	22.99 ea.
SBL-1800-____-60	Chrome Lift Latch Style 60".....	22.99 ea.
SBL-1800-1000-K	Chrome Lift Latch Style 4 Piece (2) 74" & (2) 60".....	82.76 kit
SBL-1256-____-74	Starburst Push Button Style 74".....	22.99 ea.
SBL-1256-____-60	Starburst Push Button Style 60".....	22.99 ea.
SBL-1256-1000-K	Starburst Push Button Style 4 Piece (2) 74" & (2) 60".....	82.76 kit
SBL-1205-____-74	GM Push Button Style 74"	36.99 ea.
SBL-1205-____-60	GM Push Button Style 60"	37.99 ea.
SBL-1205-1000-K	GM Push Button Style 4 Piece (2) 74" & (2) 60".....	134.96 kit
SBL-305-____-74	GM Plastic Push Button Style 74"	40.99 ea.
SBL-305-____-60	GM Plastic Push Button Style 60".....	40.99 ea.
SBL-305-1000-K	GM Plastic Push Button 4 Piece (2) 74" & (2) 60".....	139.37 kit
SBL-1803-____-74	Bowtie Lift Latch Style 74".....	51.99 ea.
SBL-1803-____-60	Bowtie Lift Latch Style 60".....	49.99 ea.
SBL-1803-1000-K	Bowtie Lift Latch Style 4 Piece (2) 74" & (2) 60".....	183.56 kit

Black = 1000	Brown = 3004	Powder Blue = 4005	Silver = 6007
Flame Red = 2006	Dark Brown = 3005	Cobalt Blue = 4006	Charcoal = 6009
Red = 2007	Med. Beige = 3008	Turquoise = 4009	Orange = 7001
Maroon = 2008	Desert Tan = 3009	Military Grn = 5002	Yellow = 7500
Red Wine = 2009	Electric Blue = 4000	Lime Green = 5004	Ivory = 8000
Purple = 2010	Blue = 4002	Dark Green = 5006	White = 9000
Tan = 3000	Dark Blue = 4004	Gray = 6005	

*Kits available in black only. Colors are special order and are non-returnable. See ss396.com for color swatches. Not all colors available for all styles. Ask your sales rep for color availability.



GM Restoration Parts

Standard Seat Belt Covers

Factory replacement plastic seat belt cover.

IBC-672B	1967-72 Black.....	16.95 ea.
IBC-672R	1967-72 Red.....	16.95 ea.
IBC-672G	1967-72 Green.....	16.95 ea.
IBC-672BL	1967-72 Blue.....	16.95 ea.



IBR-732

Shoulder Belt Retainers

Correct roof mounted shoulder belt retainers.

IBR-732	1968-70 All.....	16.99 set
---------	------------------	-----------



BSB-56

BSB-561

Seat Belt Bolts

Correct shanked style seat belt bolts.

BSB-56	All Front Outer.....	7.95 ea.
BSB-56	1967-68 Front Inner.....	7.95 ea.
BSB-561	1969-72 Front Inner.....	7.95 ea.
BSB-561	All Rear.....	7.95 ea.
BSB-5-SBL	1967-81 No Shoulder *.....	7.95 ea.

*Threaded all the way



ISB-6789

Seat Belt Retainers

Before seatbelt retractors, these clips held your seatbelt stored along your headliner.

ISB-6789	1970-71.....	33.95 pr.
----------	--------------	-----------

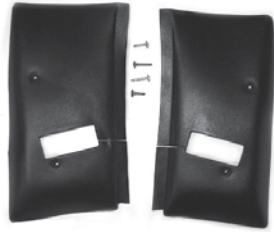

IN-337

Seat Belt Cover Trim

Correct seat belt trim panels. Black in color. Paint to match.

IN-337	1978-81 with T-Tops.....	109.95 pr.
--------	--------------------------	------------



IGE-74R

Shoulder Belt Guide Escutcheon

Holds the shoulder belt retainer to the upper portion of the bucket seat back.

IGE-74L	1974-81 LH.....	9.99 ea.
IGE-74R	1974-81 RH.....	9.99 ea.



ILG-73TGRN

ILG-73RGRN

Seat Belt Loop Guides

Choose from either triangle or rectangle style.

Triangle

ILG-73TBLK	1973-81 Black.....	9.95 ea.
ILG-73TBLU	1973-81 Blue.....	9.95 ea.
ILG-73TRED	1973-81 Red.....	9.95 ea.
ILG-73TTAN	1973-81 Tan.....	9.95 ea.
ILG-73TWTE	1973-81 White.....	9.95 ea.
ILG-73TGRN	1973-81 Green.....	9.95 ea.

Rectangle

ILG-73RBLK	1973-81 Black.....	9.95 ea.
ILG-73RBLU	1973-81 Blue.....	9.95 ea.
ILG-73RRED	1973-81 Red.....	9.95 ea.
ILG-73RTAN	1973-81 Tan.....	9.95 ea.
ILG-73RWTE	1973-81 White.....	9.95 ea.
ILG-73RGRN	1973-81 Green.....	9.95 ea.



1985-89 Seat Belt Loop Guides

ILG-8589BLK	All Black.....	39.95 pr.
-------------	----------------	-----------



ISB-67

ISB-69

Seat Belt Holders

New seat belt holders which attach to console.

ISB-67	1967.....	16.99 pr.
ISB-69	1968-69.....	12.99 ea.



SBL-BLADE

INL-15060



INL-15062

INL-15063

Standard Seat Belt Blade & Hardware

This male blade piece is used on the end of the seat belt lap belt to snap into the female receiver for both front and rear belts.

SBL-BLADE	1967-72 Standard.....	13.95 ea.
INL-15060	1967-72 Blade Deluxe.....	14.99 ea.
INL-15059	1967-72 Floor Anchor.....	14.99 ea.
INL-15062	1967-72 Shoulder Anchor.....	14.99 ea.
INL-15063	1967-72 Floor Anchor Cover Lap Belt.....	24.95 pr.



1971-74 Seat Belt Retractor Covers

Robbins Style

New reproduction seat belt retractor covers with access doors for Robbins 3200 seat belts. You can check your originals by extending out the seat belt and looking at the tag.

IBR-3200	1971-74.....	42.95 pr.
----------	--------------	-----------

Bucket Seat Backs

OE style reproduction seat backs which will replace your originals. 1967 Camaros originally came with metal seat backs but these will fit as original.

ICI-1021	1967-70 Black.....	59.95 pr.
ICI-1021FSB14	1967-70 Bright Blue.....	114.99 pr.
ICI-1021FSB16	1967-70 Dark Blue.....	114.99 pr.
ICI-1021FSB24	1967-70 Dark Green.....	114.99 pr.
ICI-1021FSB30	1967-70 Red.....	114.99 pr.
ICI-1021FSB37	1967-70 White.....	114.99 pr.
ICI-1021FSB26	1967-70 Orange.....	114.99 pr.
ISB-717	1971-77 Black.....	103.99 pr.
ISB-71714	1971-77 Bright Blue.....	121.99 pr.
ISB-71716	1971-77 Dark Blue.....	121.99 pr.
ISB-71724	1971-77 Dark Green.....	121.99 pr.
ISB-71730	1971-77 Red.....	121.99 pr.
ISB-71742	1971-77 Dark Saddle.....	124.99 pr.
ISB-71737	1971-77 White.....	121.99 pr.

No Volume Discount. Ships Oversize.



SEAT FOAM



Seat Foams

Correct density injection molded foam. Each set contains one back and one bottom.

ISF-10	1967-68 Standard.....	62.99 ea.
ISF-10K	1967-68 Standard 2 seats.....	112.99 kit
ISF-20	1967 Deluxe.....	62.99 ea.
ISF-20K	1967 Deluxe 2 seats.....	113.38 kit
ISF-40	1968 Deluxe.....	83.99 ea.
ISF-40K	1968 Deluxe 2 seats.....	149.99 kit
ISF-20	1969 Standard.....	62.99 ea.
ISF-20K	1969 Standard 2 seats.....	113.38 kit
ISF-70	1969 Deluxe.....	100.95 ea.
ISF-70K	1969 Deluxe 2 seats.....	229.99 kit
ISF-70FU	1970 Standard/Deluxe.....	139.95 ea.
ISF-71FU	1971-81 Standard.....	145.99 ea.
ISF-71FU	1971-73 Deluxe.....	145.99 ea.
ISF-78FU	1978-81 Deluxe.....	141.99 ea.
ISF-BUN8292FEU	1982-92 Standard.....	170.99 ea.
ISF-BUN8492DU	1984-92 Deluxe.....	170.99 ea.
ISF-BUN823PU-PR	1982 Pace Car.....	379.99 ea.
ISF-BUNREAR	1967-69 Rear.....	69.99 ea.
ISF-70FR	1970-81 Rear.....	228.99 kit
ISF-BUN8292FEFC	1982-92 Rear Solid Back.....	333.99 ea.
ISF-BUN8292FECS	1982-92 Rear Split Back.....	333.99 ea.

Ships Oversize 2.

SEAT FRAMES

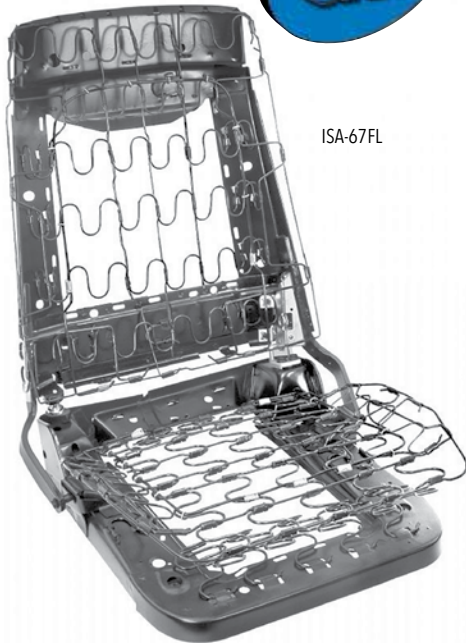

ISA-67FL

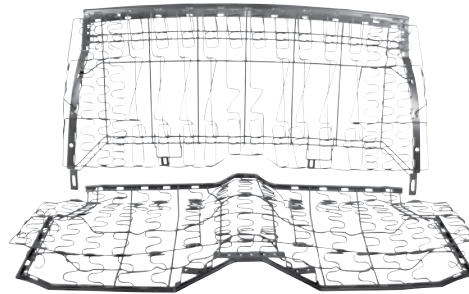

ISF-1052G

Rear Seat Frames

Complete rear seat frame assembly with springs. Excellent for converting from standard interior to deluxe interior.

ISF-1052G	1967-69 Std Coupe, 1968-69 Dlx Coupe.....	649.95 ea.
ISF-1052H	1967-69 Std Convertible, 1967 Dlx Coupe, 1968-69 Dlx Convertible.....	649.95 ea.

No Volume Discount. Ships Oversize 2.

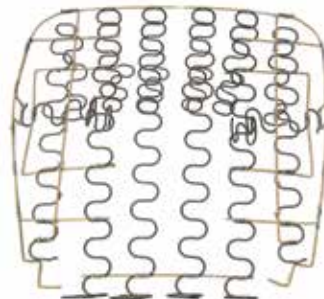

IZ-204

Bucket Seat Springs

Restore the comfort of your buckets with brand new springs!

IZ-201	1967-69 Bottom.....	89.99 ea.
IZ-202	1967-69 Back.....	84.99 ea.
IZ-104	1967-69 Side Support.....	21.95 kit

No Volume Discount. Ships Oversize.

SEAT CARPET



ISC-8X

Rear Fold Down Seat Carpet

Correct 80/20 Rayon/Nylon looped carpet for the optional fold down seat partition.

ISC-8X	1967-68.....	43.95 ea.
ISC-9X	1969.....	43.95 ea.

Available in: Black, Red, Bright Blue, Gold, Turquoise (Aqua), Medium Blue (68 Blue), Ivy Gold, Dark Blue and Dark Green

Bucket Seat Frame

Complete bucket seat frame with springs installed. Highest quality on the market!

ISA-67FL	1967-68 LH.....	299.95 ea.
ISA-67FR	1967-68 RH.....	299.95 ea.
ISA-67F	1967-68 Set LH/RH.....	799.99 kit
ISA-69FL	1969 LH.....	299.95 ea.
ISA-69FR	1969 RH.....	299.95 ea.
ISA-69F	1969 Set LH/RH.....	799.99 kit

1969 requires headrest hardware, sold separately.

No Volume Discount. Ships Oversize 2.

SEAT PARTITION



ISP-7X

Rear Fold Down Seat Partition

Correct divider board

ISP-7X	1967	27.99 ea.
ISP-8X	1968-69	26.95 ea.

Available in: Black, Bright Blue, Red, Light Blue, Dark Blue, Light Blue, Light Green, Dark Green
Ships Oversize 1.

HEAD RESTS/COVERS



ICI-3CB

Bucket Seat Head Rests

Available as a safety standard for the first time in 1969, our complete headrest assemblies include your choice of a straight or curved bar and feature the correct Madrid grain. Cars built before 4/69 used a straight bar and cars built after 4/69 used a curved bar.

ICI-367	1967 Straight Bar	264.99 pr.
ICI-3100	1969 Straight Bar Black	218.99 pr.
ICI-3CB	1969 Curved Bar Black	269.99 pr.
ICI-3100_	1969 Straight Bar Color	211.99 pr.
ICI-3CB_	1969 Curved Bar Color	269.99 pr.

Available in 10 Black, 16 Dark Blue, 23 Light Metallic Green, 24 Dark Metallic Green, 26 Orange, 30 Red and 37 White
See page 4 for color swatches. No volume discount.



ICI-569



Headrest Escutcheon

This is the correct chrome headrest escutcheon. It is attached to the lock bracket and knob assembly which releases or locks the headrest.

ICI-569	1969 Buckets	15.95 pr.
---------	--------------	-----------

SEAT HARDWARE



IK-410

Rear Fold Down Seat Partition Holder

Correct holder which attaches behind the rear seat and holds the bottom of the fold down rear seat partition in place.

IK-410	1967-69	42.95 ea.
--------	---------	-----------



IFD-1B

Rear Fold Down Seat Brackets

Correct rear fold down seat brackets which weld or bolt to the floor pan.

IFD-1B	1967-69	39.95 pr.
--------	---------	-----------



IC-465

ICC-69L

Rear Fold Down Seat Latches

OE style reproduction latches for fold down rear seat.

IC-465	1967	11.95 pr.
ICC-69L	1968-69	59.95 ea.



ISS-7X

ISS-8X

Rear Fold Down Seat Rubber Stoppers

Correct rubber stoppers for fold down rear seat.

ISS-7X	1967	8.95 pr.
ISS-8X	1968-69	9.95 pr.



ISB-735

Bucket Seat Back Retainers

New seat back retainers featuring the correct gauge steel stamping as original. These retainers work with both plastic and metal style seat backs and also allows plastic style panels to be installed on 67 seat frames.

ISB-735	1967-69 All	16.99 pr.
---------	-------------	-----------

Metal style seat backs require 1 retainer per seat, while the 68-69 plastic style seat backs require 2 per seat. Hardware not included.

IHG-7



Seat Cover Installation Kit

Complete set of hog rings and pliers for seat cover installation.

IHG-7	All	16.95 kit
-------	-----	-----------



ICI-20

Side Hinge Covers

OE style reproduction injection molded plastic covers used to cover the brackets between the tops and bottoms of the seats.

ICI-20	1967-70 Buckets	23.99 pr.
IT-39200	1971-81 Buckets	49.95 pr.



ICQ-387

Seat Back Stoppers

Correct rubber coated steel seat stoppers.

ICQ-387	1967-70 Buckets	4.99 pr.
---------	-----------------	----------



ILH-67FL

Seat Back Latch Hook

Used to secure the seat back in place.

ILH-67FL	1967-69 LH	8.95 ea.
ILH-67FR	1967-69 RH	8.95 ea.



ISL-1052C

Seat Back Latches

Correct seat back latches which mount to the back of the seat and latches to the seat bottom.

ISL-1052D	1968-69 LH	49.99 ea.
ISL-1052C	1968-69 RH	49.99 ea.



ICI-75

Seat Back Chrome Locking Knob

Correct chrome knob used to tilt the seat forward and backward.

ICI-75	1967-70 Buckets	6.99 ea.
--------	-----------------	----------



ICI-315



ICE-4636

Seat Adjustment Knobs

ICI-315	1967-81 Chrome	8.99 ea.
ICE-4636	1967-81 Black	6.95 ea.

SEAT HARDWARE *continued*



IST-1054A

Bucket Seat Tracks

Beautiful reproduction seat tracks.

IST-1054A	1967-69 LH 2pc.....	79.95 ea.
IST-1054	1967-69 RH 2pc.....	79.95 ea.
IST-7074	1970-74 All LH/RH.....	138.99 pr.
IST-7581L	1975-81 All LH.....	236.99 pr.
IST-7581R	1975-81 All RH.....	236.99 pr.



ISE-679

Bucket Seat Track Extenders

These extenders mount to the floor on the drivers side and offset the seat tracks about two inches giving the driver more leg room.

ISE-679	1967-69 Driver Side.....	79.95 pr.
---------	--------------------------	-----------



BST-12655

Seat To Track Bolts

Correct bolts to mount seats to seat tracks. 3 dash and 23 head markings.

BST-12655	1967-69 8pc.....	16.95 kit
-----------	------------------	-----------

Note: Buckets use all 8 and bench uses 4.



IZ-7581

Seat Release Cables

Reproduction seat release cable front bucket seats release the seat track when the seat track adjustment knob is engaged. Designed for manual style seat tracks only. 1 pair required per vehicle.

IZ-7581	1975-81.....	39.99 pr.
---------	--------------	-----------



RSB-1052R

Front Seat Brackets

Correct front seat mounting brackets which spot weld to the floor and also support the rear of the subframe.

RSB-1052L	1967-69 LH.....	39.95 ea.
RSB-1052R	1967-69 RH.....	39.95 ea.



RSB-1053L

Rear Seat Brackets

Correct rear seat mounting brackets which spot weld to the floor to support the bottom of the rear seat.

RSB-1053L	1967-69 LH.....	36.95 ea.
RSB-1053R	1967-69 RH.....	36.95 ea.



RSB-1051

Seat Frame Supports

Correct seat frame supports which attach to the front seat floor brackets.

RSB-1051	1967-69 Coupe LH.....	54.95 ea.
RSB-1050	1967-69 Coupe RH.....	54.95 ea.
RSB-1052A	1967-69 Conv LH.....	59.95 ea.
RSB-1052B	1967-69 Conv RH.....	59.95 ea.



OER Interior Paint

OER's revolutionary formula provides 40% more coverage than standard dyes and lacquers and actually penetrates and molecularly bonds to the surface to permanently seal in the color. Dries to the touch in 45 seconds, forms a complete bond in just 10 minutes. UV stable and color fast, it will not crack, flake or peel. For use on vinyl, leather, ABS plastic, polycarbonate, polypropylene, polyurethane, acrylic, lexan, fiberglass and recycled plastics. These paints are designed to match our colored PUI interior products. 12oz aerosol can.

HPP-802RED	M30 Red.....	17.99 ea.
HPP-804BBLU	M14 Bright Blue.....	17.99 ea.
HPP-808MBLU	M17 Medium Blue.....	17.99 ea.
HPP-809IGLD	M46 Ivy Gold.....	17.99 ea.
HPP-810WHITE	M37 White.....	17.99 ea.
HPP-811ORNG	M126 Hugger Orange.....	17.99 ea.
HPP-813DGRN	M24 Dark Green.....	17.99 ea.
HPP-820CAMEL	Z48 Camel Tan.....	17.99 ea.
HPP-829FTHR	Z45 Firethorn Red.....	17.99 ea.
HPP-830CARM	Z38 Carmine.....	17.99 ea.
HPP-1009	Surface Prep.....	9.99 ea.

Paint can not be shipped via air. Ground shipping only.

- Made in USA • OEM Colors, OEM Materials
- "Out of the Box" Installation



PUI Standard Pre-Assembled Door Panels for 1967-69 Camaro

These PUI door panels are constructed of the finest quality materials available. These door panels are perfect for most cars out there whether they are daily drivers or trailer queens. All panels come pre-assembled with moldings and PUI Windowfelts already installed. Take them out of the box, hang them on and you're ready to go! *All door panels ship Oversize*

PUI Standard Pre-Assembled Door Panel Kits

Replace your front and rear door panels all in one shot and save with this specially priced PUI door panel kit! Each kit includes one set of front PUI front door panels and a set of rear PUI door panels to get your interior looking showroom fresh.

IDA-67FK	1967 Standard Coupe.....	244.78 kit
IDA-67FVK	1967 Standard Convertible.....	206.98 kit
IDA-68FK	1968 Standard Coupe.....	337.48 kit
IDA-68FVK	1968 Standard Convertible.....	337.48 kit
IDA-69FK	1969 Standard Coupe.....	337.48 kit
IDA-69FVK	1969 Standard Convertible.....	337.48 kit

Black only. All door panels ship Oversize. No volume discount.



IDA-68FK



IDA-67FK



IDA-69FK



IPA-760

1967 Standard Door Panels - Pre-Assembled*

Madrid grain vinyl dielectrically sealed with stitch bar and trim moldings.

IPA-760	All Front.....	187.99 pr.
IPA-761	Coupe Rear.....	83.99 pr.
IPA-761V*	Convertible Rear	41.99 pr.

Platinum Edition - Crisper, more beveled pleats just like the original

IPP-6710	All Front.....	212.99 pr.
IPP-6710C	Coupe Rear.....	86.99 pr.
IPP-6710V*	Convertible Rear	50.99 pr.

**Convertible rears are not assembled.*

Available in: Black (10), Light Blue (12), Red (30), White (37) and Gold (43)



1967 Upper Door Panel Molding

This upper molding retains the door panels to the door on cars with standard interior.

IRM-67FF	1967 Front	42.99 ea.
IRM-67FR	1967 Rear	39.99 ea.

2 required per car.



IPA-986

1968 Standard Door Panels - Pre-Assembled

Madrid grain vinyl dielectrically sealed with stitch bar with trim moldings, top rails, window felts and door lock ferrules.

IPA-986	All Front.....	218.99 pr.
IPA-986H	Coupe Rear.....	155.99 pr.
IPA-986V	Convertible Rear	155.99 pr.

Platinum Edition - Crisper, more beveled pleats just like the original

IPP-6810	All Front.....	282.99 pr.
IPP-6810C	Coupe Rear.....	197.99 pr.
IPP-6810V	Convertible Rear	191.99 pr.

Available in: Black (10), 68 Blue (17), Red (30), White (37) and Ivy Gold (46)



IPA-989

1969 Standard Door Panels - Pre-Assembled

Madrid grain vinyl with dielectrically sealed horizontal design with trim moldings, top rails, window felts and door lock ferrules.

IPA-989	All Front.....	218.99 pr.
IPA-989H	Coupe Rear.....	155.99 pr.
IPA-989V	Convertible Rear	155.99 pr.

Platinum Edition - Crisper, more beveled pleats just like the original

IPP-6910	All Front.....	291.99 pr.
IPP-6910C	Coupe Rear.....	197.99 pr.
IPP-6910V	Convertible Rear	191.99 pr.

Available in: Black (10), Dark Blue (16), Light Green (23), Dark Metallic Green (24), Red (30) and White (37)

Deluxe Door Panels 1967-69 Camaro

These new, OE style reproduction deluxe door panels are designed as original and feature the correct grains and materials. The front panels are injection molded and are unassembled. The rears are PUI panels and come pre-assembled with moldings, upper steel rails and window felts. 1967 rear panels are not pre-assembled. *Please state color at time of order. All door panels ship Oversize.*



IDX-701



IDX-801

1967 Deluxe Door Panels

Front door panels are correct Madrid grain vinyl with color keyed carpeting. Rear panels are Madrid grain vinyl with dielectrically sealed horizontal pleats.

IDX-701	Deluxe Front.....	552.99 pr.
IDX-201	Deluxe Rear Coupe	93.99 pr.
IDX-201V	Deluxe Rear Convertible	90.99 pr.

Rears are not pre-assembled. Front Ship Oversize 2. No Volume Discount.

Available in: Black, Red, Aqua, Gold, Bright Blue and Off White



7669268



7669267



7742918



7743242

1968-69 Deluxe Door Panels

Front door panels are correct Madrid grain vinyl with color keyed carpeting.

IDX-801	Deluxe Front Black	552.99 pr.
---------	--------------------------	------------

Rear panels are Madrid grain vinyl with top rails, trim moldings and window felts.

IDX-301	Deluxe Rear Coupe	218.99 pr.
IDX-301V	Deluxe Rear Convertible	212.99 pr.

Front Ship Oversize 2.

No Volume Discount.

Available in: Black, Red, Aqua, 68 Medium Blue, Pearl, Ivy Gold, Dark Blue, Dark Green, Orange, White and Yellow

Deluxe Door Panel Moldings

OE style reproduction deluxe door panel moldings produced in stainless material as original.

7669267	1967 Center Molding	64.95 ea.
7669268	1967 Upper Molding.....	64.99 ea.
7742918	1968-69 Upper RH Molding.....	55.99 ea.
7742919	1968-69 Upper LH Molding	52.99 ea.
7743242	1968-69 Lower Molding	49.99 ea.



- Made in USA
- OEM Colors, OEM Materials
- "Out of the Box" Installation for most applications

PUI Standard Door Panels for 1970-81 Camaro

These PUI door panels are constructed of the finest quality materials available. These door panels are perfect for most cars out there whether they are daily drivers or trailer queens. Most panels come pre-assembled with moldings and PUI Windowfelts already installed unless noted. Take them out of the box, hang them on and you're ready to go!

Please state color at time of order. All door panels ship Oversize.



IPA-70S

1970-71 Standard Door Panels

Madrid grain vinyl with dielectrically sealed vertical lines.

IPA-70S	All Front.....	135.99 pr.
---------	----------------	------------

Top rails, arm rests and map pockets not included.

Available in: Black, Bright Blue, Dark Metallic Green, Saddle, Sandalwood, Blue, Jade Green and Dark Saddle



IPA-72S

1972 Standard Door Panels

Madrid grain vinyl with dielectrically sealed vertical lines.

IPA-72S	All Front.....	131.99 pr.
---------	----------------	------------

Top rails, arm rests and map pockets not included.

Available in: Black, Blue, Dark Green, Covert, White and Tan.



IPA-73S

1973-75 Standard Door Panels

Madrid grain vinyl with dielectrically sealed vertical lines.

IPA-73S	All Front.....	146.99 pr.
---------	----------------	------------

Top rails, arm rests and map pockets not included.

Available in: Black, Dark Green, Covert, Dark Saddle



IPA-76S

1976 Standard Door Panels - Pre-Assembled

Madrid grain vinyl with dielectrically sealed vertical lines with top rail, door lock ferrule and window felts.

IPA-76S All Front..... 280.99 pr.
Arm rests and map pockets not included.
Available in: Black, Firethorn, Saddle and White.



IPA-77S

1977 Standard Door Panels - Pre-Assembled

Sierra grain vinyl with dielectrically sealed vertical lines with top rail, door lock ferrule and window felts.

IPA-77S All Front..... 280.99 pr.
Arm rests and map pockets not included.
Available in: Black, Saddle, White and Firethorn



IPA-78S

1978-81 Standard Door Panels - Pre-Assembled

Sierra grain with dielectrically sealed vertical stitchbar with trim moldings, top rails, window felts and door lock ferrules.

IPA-78S All Front..... 291.99 pr.
Available in: Black, White, Carmine, Camel, Willow Green, Light Blue, Navy Blue, Light Saddle, Silver, Red and Oyster



IPA-78FDLT70-P

1978-79 Berlinetta Custom Vinyl Door Panels

Sierra grain vinyl and Rattan grain vinyl inserts with dielectrically sealed vertical lines in inserts. The bottoms are carpeted. Trim moldings, top rails, window felts and door lock ferrules are installed.

IPA-78FDLT__P All Front..... 399.95 pr.
Available in: Black (70), White (37), Carmine (38), Camel (48) and Light Blue (90).



IPA-78FDLTC70-P

1978-79 Berlinetta Custom Cloth Door Panels

Sierra grain vinyl and Empress grain cloth inserts with dielectrically sealed vertical lines in inserts. The bottoms are carpeted. Trim moldings, top rails, window felts and door lock ferrules are installed.

IPA-78FDLTC__P All Front..... 399.95 pr.
Available in: Black (70), White (37), Carmine (38), Camel (48) and Light Blue (90).

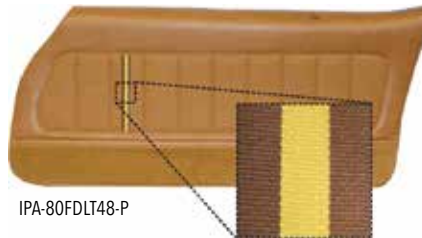

IPA-80FDLT48-P

1980-81 Berlinetta Custom Vinyl Door Panels

Sierra grain vinyl with Derma grain vinyl inserts with dielectrically sealed vertical lines in insert and carpeted bottoms. Features 2 tone accent stripes in insert.

IPA-80FDLT__P All Front..... 467.99 pr.
Available in: Black (70), Navy (18), Carmine (38), Camel (48), Silver (66), Bright Red (77) and Oyster (81).

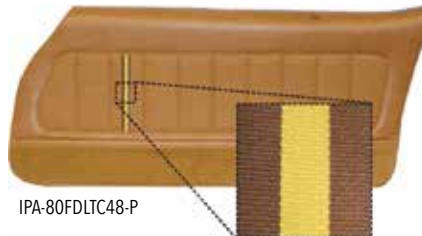

IPA-80FDLTC48-P

1980-81 Custom Cloth Door Panels

Sierra grain vinyl with Empress cloth inserts and sewn vertical lines in inserts and carpeted bottom. Includes top rails, window felts and door lock ferrule. Features 2 tone accent stripes in insert.

IPA-80FDLTC__P All Front..... 467.99 pr.
Available in: Black (70), Navy (18), Carmine (38), Camel (48), Silver (66), Bright Red (77) and Oyster (81).



IPA-82FD02-PB

1982-86 Standard Door Panels

Front door panels are made of the correct grain vinyl designed to match the originals.

IPA-82FD__PB 1982-85 Front..... 280.99 pr.
(02) Gray, (70) Charcoal, (18) Dark Blue, (38) Maroon, (48) Camel
IPA-86FD__PB 1986 Front..... 369.99 pr.
(02) Gray, (70) Charcoal, (04) Saddle, (38) Maroon



IPA-82DD66-PB

1982 Pace Car Door Panels

IPA-82DD66-PB 1982 Pace Car 332.99 pr.



IDP-82FDRAIL-B

1970-92 Upper Door Panel Rail Trim

Made from injection molded plastic, these rails will replace your missing or cracked originals.

IDP-UP 1970-73 All 119.99 pr.
IDP-82FDRAIL-B 1982-92 All Black Bead..... 159.99 pr.
IDP-82FDRAIL-C 1982-92 All Chrome Bead 173.99 pr.



IDP-LR

1970-77 Lower Door Panels

Correct reproduction of the 1970-77 standard lower door panels which feature the correct grain as original and include the proper mounting locations for the arm rest pads.

IDP-LL 1970-71 All LH 109.99 ea.
IDP-LR 1970-71 All RH 109.99 ea.
IDP-LL77 1972-77 All LH 126.99 ea.
IDP-LR77 1972-77 All RH 126.99 ea.



ISP-71L

1970-81 Rear Lower Side Panels

OE style reproduction of these often missing interior lower rear side panels. These panels feature the correct grain as original and can be painted to match your interior.

ISP-71L 1970-81 All LH 79.95 ea.
ISP-71R 1970-81 All RH 79.95 ea.
ISP-71L-R 1970-81 All LH Red 79.95 ea.
ISP-71R-R 1970-81 All RH Red 79.95 ea.
ISP-71L-T 1970-81 All LH Tan 82.95 ea.
ISP-71R-T 1970-81 All RH Tan 79.95 ea.
ISP-71L-W 1970-81 All LH White..... 79.95 ea.
ISP-71R-W 1970-81 All RH White 79.95 ea.

Sport R Door Panels

TMI's new Sport R Door Panels for the Camaro hold on to the iconic styling cues that make a Camaro interior so easily recognizable. However, these new Sport R Door Panels do a great job of modernizing the originals by adding a french seam stitched in a contrasting thread color and by accenting the insert sections of the door panels with a matching black unisuede. This result is a very modern looking door panel that takes hints from the classic Camaro style - and fits right in place of the original panels!

- Suede inserts • Choice of colored stitching
- Masonite MDF back board • Metal top plates (1968-69)
- Window Felts (1968-69) • Pre-cut holes in board for door handles and cranks • Includes lock grommet and chrome strip (1968-69) • Offers a modern look for your classic

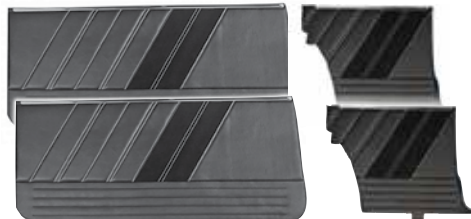

TMI-SRDCA67-0003

TMI-SRQCACV67-0027

1967-69 TMI Sport R Front & Rear Door Panels

Black vinyl and suede with red stitching.

TMI-SRDCA67-0003	1967 Front.....	290.99 kit
TMI-SRQCACV67-0021	1967 Rear Coupe.....	186.99 kit
TMI-SRQCACV67-0027	1967 Rear Cvt.....	186.99 kit
TMI-SRDCA68-0009	1968 Front.....	610.99 kit
TMI-SRDCA69-0015	1969 Front.....	610.99 pr.
TMI-SRQCACV689-0032	1968-69 Rear Coupe.....	459.99 kit
TMI-SRQCACV689-0038	1968-69 Rear Cvt.....	459.99 kit

Sport XR Door Panels

TMI's Sport XR Door Panels for the Camaro hold on to the iconic styling cues that make a Camaro interior so easily recognizable. However, these Sport XR Door Panels do a great job of modernizing the originals by adding a French seam stitched in a contrasting thread color and by accenting the insert sections of the door panels with a matching black unisuede. This result is a very modern looking door panel that takes hints from the classic Camaro style - and fits right in place of the original panels!



TMI-SXRDC67-0003

TMI-SXRQPCCA6890063

1967-69 TMI Sport XR Front & Rear Door Panels

Black vinyl and suede with red stitching.

TMI-SXRDC67-0003	1967 Front w/ Red Stitch Stainless Grommet	327.99 pr.
TMI-SXRQPCCA67-0039	1967 Rear w/ Red Stitch Stainless Grommet	222.99 pr.
TMI-SXRDC68-0015	1968 Front w/ Red Stitch Stainless Grommet	690.99 pr.
TMI-SXRDC69-0027	1969 Front w/ Red Stitch Stainless Grommet.....	690.99 pr.
TMI-SXRQPCCA6890063	1968-69 Rear w/ Red Stitch Stainless Grommet	501.99 pr.



Sport 2 Door Panels

TMI's Sport 2 Molded Door Panels for the Camaro hold on to the iconic styling cues that make a Camaro interior so easily recognizable. However, these Sport 2 Door Panels do a great job of modernizing the originals in a contrasting thread color and by accenting the insert sections of the door panels with a matching black unisuede. They also incorporate a molded in arm rest similar to the factory deluxe door panels. This result is a very modern looking door panel that takes hints from the classic Camaro style - and fits right in place of the original panels!



TMI-MSDCA68-1

TMI-MSQCACP68-13

1968-69 TMI Sport 2 Front & Rear Door Panels, Black Molded

TMI-MSDCA68-1	1968 Front.....	585.99 pr.
TMI-MSDCA69-7	1969 Front	585.99 pr.
TMI-MSQCACP68-13	1968-69 Rear.....	351.99 pr.

This item ships oversize.

Sport R Molded Door Panels

TMI's new Sport R molded Door Panels for the Camaro hold on to the iconic styling cues that make a Camaro interior so easily recognizable. However, these new Sport R Door Panels do a great job of modernizing the originals by adding a French seam stitched in a contrasting thread color and by accenting the insert sections of the door panels with a matching black unisuede. They also incorporate a molded-in arm rest similar to the factory deluxe door panels. This result is a very modern looking door panel that takes hints from the classic Camaro style - and fits right in place of the original panels!



TMI-MSRDCA68-27

TMI-MSRQCACP689-39

1968-69 TMI Sport R Front & Rear Door Panels, Black Molded

TMI-MSRDCA69-33	1969 Front Red Stitch.....	682.99 pr.
TMI-MSRDCA68-27	1968-69 Front Red Stitch ..	682.99 pr.
TMI-MSRQCACP689-39	1968-69 Rear Red Stitch ...	409.99 pr.

Call for custom color combo. This item ships oversize.



Sport XR Molded Door Panels

TMI's new Sport XR molded Door Panels for the Camaro hold on to the iconic styling cues that make a Camaro interior so easily recognizable. However, these new Sport XR Door Panels do a great job of modernizing the originals by adding a French seam stitched in a contrasting thread color and by accenting the insert sections of the door panels with a matching black unisuede. They also incorporate a molded-in arm rest similar to the factory deluxe door panels. This result is a very modern looking door panel that takes hints from the classic Camaro style - and fits right in place of the original panels!



TMI-MSXDCA68-45

TMI-MSXQCACP689-99

1968-69 TMI Sport XR Front & Rear Door Panels, Black Molded

TMI-MSXDCA69-57	1969 Front Red Stitch & Stainless Grommet	750.99 pr.
-----------------	---	------------

TMI-MSXDCA68-45	1968-69 Front Red Stitch & Stainless Grommet	750.99 pr.
-----------------	--	------------

TMI-MSXQCACP689-99	1968-69 Rear Red Stitch & Stainless Grommet	449.99 pr.
--------------------	---	------------

This item ships oversize.



TMI offers a wide variety of customized high quality interior components for your muscle car. With multiple color options available, different grommets options, customize your stitch or fabric. There's many options to make your interior different from the rest!

Please call or go online to SS396.com for see more options.

Color swatches are available. Customized products can take up to 8 weeks.

DOOR PANEL EMBLEMS



ICI-0842 ICI-4309



ICI-0781 ICI-4303



IE-781 ICI-4304



IE-8008 ICI-4306



ICI-045 ICI-4307



ICI-4302 ICI-4305



ICI-4308

Door Panel Emblems

OE style reproduction emblems for your Camaro.

ICI-0842	1967 Standard	21.95 pr.
IE-781	1967 Deluxe	21.95 pr.
ICI-0781	1968-69 Standard.....	23.99 pr.
IE-8008	1968-69 Deluxe.....	21.95 pr.
ICI-4302	1974-78 Type LT	89.99 pr.
ICI-4305	1974-79 Camaro Red White Blue....	89.99 pr.
ICI-4303	1974-81 Super Sport SS	89.99 pr.
ICI-4304	1974-81 Black Bowtie.....	89.99 pr.
ICI-4306	1977-79 Red Z/28.....	99.99 pr.
ICI-4307	1977-79 Black Z/28.....	99.99 pr.
ICI-045	1978-81 Deluxe.....	39.99 pr.
ICI-4308	1979-81 Berlinetta	99.99 pr.
ICI-4309	1979-81 Camaro Orange.....	99.99 pr.

DOOR PANEL ACCESSORIES

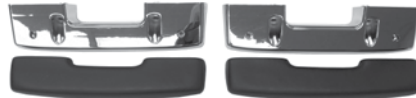

ARM-KIT1

1967 Front Arm Rest Pad & Base Kit

Complete kits with 2 arm rest bases and 2 front arm rest pads.
ARM-KIT1 1967 Black.....58.56 kit



ARM-KIT4

1968-69 Front Arm Rest Pad & Base Kits

Complete kits with 2 arm rest bases and 2 front arm rest pads.

ARM-KIT4	Black	62.24 kit
ARM-KITA10	White	99.95 kit
ARM-KITA20	Pearl	99.95 kit
ARM-KITA30	Red	99.95 kit
ARM-KITA40	Parchment	99.95 kit
ARM-KITA50	Light Saddle	99.95 kit
ARM-KITA60	Dark Saddle	99.95 kit
ARM-KITA65	Light Blue.....	99.95 kit
ARM-KITA70	Dark Blue	99.95 kit
ARM-KITA75	Bright Blue	99.95 kit
ARM-KITA80	Dark Green	99.95 kit
ARM-KITA85	Sandalwood	99.95 kit

No volume discount.



ICI-5101R



ICI-5151

Arm Rest Pads

OE style reproduction arm rest pads.

ICI-5001	1967	18.95 ea.
ICI-5101L	1968-69 LH All.....	18.95 ea.
ICI-5101R	1968-69 RH All	18.95 ea.
ICI-5151	1970-71 All LH or RH	34.99 ea.
ICI-5152	1972-77 With 2pc Panel.....	41.99 ea.
ICI-74R	1974-81 RH	70.00 ea.
ICI-74L	1974-81 LH	69.99 ea.
IXP-03	Attaching Screw.....	0.50 ea.



ICI-5011



ICI-1960R

Arm Rest Bases

OE style reproduction chrome plated and plastic arm rest bases.

ICI-5011	1967	13.95 ea.
ICI-1960L	1968-69 LH Black.....	19.95 ea.
ICI-1960R	1968-69 RH Black.....	19.95 ea.
IXP-997	Attaching Screw.....	0.75 ea.



Arm Rest Bases – Colors

Replacement arm rest bases now available in colors!

ARMBASE-PARCH	Parchment	26.95 pr.
ARMBASE-RED	Red.....	26.95 pr.
ARMBASE-BBLUE	Bright Blue.....	26.95 pr.
ARMBASE-DGREEN	Dark Green.....	26.95 pr.
ARMBASE-WHITE	White.....	26.95 pr.
ARMBASE-DBLUE	Dark Blue.....	26.95 pr.



IK-504

Rear Arm Rest Panels

Correct die-stamped steel upper and lower arm rest panels for your deluxe coupe, coupe with fold down rear seat or convertible.

IK-504	1967-69 RH Coupe Dlx.....	69.99 ea.
IK-505	1967-69 LH Coupe Dlx	69.99 ea.
IK-506	1967-69 RH Conv.....	69.99 ea.
IK-507	1967-69 LH Conv.....	69.99 ea.



IK-508

Convertible Inner Side Panels

OE style reproduction of the original steel inner side panels which are located directly above the rear arm rest section where the top frame folds down.

IK-508	1967-69 RH	64.99 ea.
IK-509	1967-69 LH	64.99 ea.



IAT-69R



IAT-68C

Arm Rest Ash Trays

Correct chrome ash tray for rear arm rests.

IAT-69R	1967 Ribbed.....	42.99 ea.
IAT-68C	1968-74 Ribbed.....	29.95 ea.
IAT-70C	1968-74 Smooth.....	29.95 ea.

DOOR PANEL ACCESSORIES *continued*

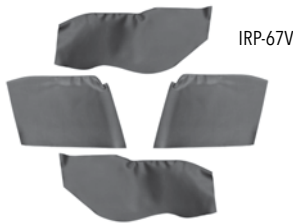

IRP-67V

Rear Arm Rest Piston Covers

Correct die-stamped vinyl material for covering convertible rear arm rest and piston covers.

- IRP-67V 1967-69 Convertible.....67.99 set
- IRP-67VC 1967-69 Dix Coupe.....60.99 set

Please state color at time of order.



IVH-733

1967 Vent Window

Vent window pivot stud and handle kit includes: two faithful reproduction vent window stud assemblies with polished stainless caps, two fiber gaskets, two rubber gaskets, two internal plastic bushing spacers, four special wave washers (two extra), RH and LH vent window chrome die cast handles with roll pins.

- IVH-733 Pivot Stud & Handle Kit.....79.99 kit
- IVH-67 Handles Only 39.95 pr.
- IVH-741 Pivot Stud Assembly Only20.99 kit
- IVH-742 Pivot Stud Nut Chrome5.99 ea.

Pieces also available separately.



IPQ-82F

1982-92 Window Crank

Reproduction window crank handle for 1982-92 Camaro models. Available in black. Includes mounting clip.

- IPQ-82F ALL5.99 ea.



IPX-4078B

IPX-4078C

Window Cranks & Hardware

OE style reproduction window cranks in kits or individually! Include 4 cranks, 4 clips and 4 gaskets.

- IPX-4078C 1967-69 Clear Knob Kit26.70 kit
- IPX-4078B 1967-69 Black Knob Kit26.70 kit
- IPQ-4080C 1967-69 Clear Knob 6.95 ea.
- IPQ-4080B 1967-69 Black Knob 6.95 ea.
- IPQ-82F 1982-92 All Black 5.99 ea.
- IPX-3850 All Gasket 1.95 ea.
- IPX-39 All Spring 1.95 ea.
- IPX-38 All Clip 0.75 ea.

No Volume Discount on kits.

IPX-67GMKIT-BLK



1967-72 Factory Correct Window Cranks

Quality die cast. Correct spline depth and clip engagement. Shorter and with a flatter curvature than later years, with correct thin knob. All 1968 and 1969 rears feature cast number 9715291. 1969 rear and all 1970-72 features cast number 9717838. Clips are included.

- IPX-67GMKIT-BLK 1967 Black Knob 4pc..... 47.81 ea.
- IPX-67GMKIT-CLR 1967 Clear Knob 4pc..... 47.81 ea.
- IPX-68GMKIT-BLK 1968 Black Knob 4pc..... 56.82 ea.
- IPX-68GMKIT-CLR 1968 Clear Knob 4pc..... 50.82 ea.
- IPX-69GMKIT-BLK 1969 Black Knob 4pc..... 53.82 ea.
- IPX-69GMKIT-CLR 1969 Clear Knob 4pc..... 53.82 ea.
- IPO-67GMB 1967 Black Knob..... 12.99 ea.
- IPO-67GMC 1967 Clear Knob..... 12.99 ea.
- IPO-68GMB 1968-69 Front, 68 Rear Black Knob..... 16.99 ea.
- IPO-68GMC 1968-69 Front, 68 Rear Clear Knob..... 14.99 ea.
- IPO-69RGMB 1970-72 Front, 69 Rear Black Knob..... 14.99 ea.
- IPO-69RGMC 1970-72 Front, 69 Rear Clear Knob..... 16.99 ea.



ICE-4814K

ICE-3520X

Standard Door Handles

Excellent quality reproduction door handles. Buy the pair and save!

- ICE-4814K 1967 17.93 pr.
- ICE-4814 1967 Fits LH & RH 11.95 ea.
- ICE-3520X 1968-69 26.93 pr.
- ICE-3520L 1968-69 LH 17.95 ea.
- ICE-3520R 1968-69 RH 17.95 ea.



IHK-64B

IHK-68C

Window Crank & Door Handle Kits

Save when you buy the kit! This is a set of OE style reproduction window cranks and inside door handles. including (4) cranks, (4) clips and (4) gaskets, (2) handles with clips.

- IHK-64B 1967 Black Knob Kit44.63 kit
- IHK-64C 1967 Clear Knob Kit.....44.63 kit
- IHK-68B 1968-69 Black Knob Kit..... 53.63 kit
- IHK-68C 1968-69 Clear Knob Kit 53.63 kit



PT-202

PT-203

PT-204

Clayton Machine Works Handles

Easily add a nice custom touch to your interior with these custom handles from Clayton Machine Works! These handles are CNC machined and powdercoated a satin silver. The perimeter and inside truss edges are then re-machined for subtle yet dynamic highlight. A great match to Clayton pedals!

- PT-202 Door Handles 127.99 pr.
- PT-203 Window Cranks 132.99 pr.
- PT-204 Vent Window Cranks 116.99 pr.

No Volume Discount



TRIM-02

TRIM-01

TRIM-WR

TRIM-KIT

TRIM-MAG

Trim Removal Tools

- TRIM-01 All 9.97 ea.
- TRIM-02 All 5.95 ea.
- TRIM-WR Window Roller Removal Tool 14.95 ea.
- TRIM-KIT Trim Removal Kit 5pc..... 24.95 set
- TRIM-MAG Mirror & Magnet Kit 2pc 14.95 set

AMK inc PRODUCTS

ISK-70F



Interior Screw Kits

These kits offer the most commonly missing or rusted special style interior screws. All screws are individually bagged and labeled to make replacement painless!

BASIC

- ISK-64A 1967 All22.95 kit
- ISK-68F 1968-69 All29.95 kit
- ISK-70F 1970-73 All21.95 kit

OEM COMPLETE • OVER 300 PIECES

- 67FN-CPS 1967 Coupe, Standard 181.99 set
- 67FN-CPD 1967 Coupe, Deluxe 189.99 set
- 67FN-CVS 1967 Convertible, Standard..... 154.99 set
- 67FN-CVD 1967 Convertible, Deluxe 158.99 set
- 68FN-CPS 1968 Coupe, Standard 181.99 set
- 68FN-CPD 1968 Coupe, Deluxe 205.99 set
- 68FN-CVS 1968 Convertible, Standard..... 172.99 set
- 68FN-CVD 1968 Convertible, Deluxe 174.99 set
- 69FN-CPS 1969 Coupe, Standard 189.99 set
- 69FN-CPD 1969 Coupe, Deluxe 223.99 set
- 69FN-CVS 1969 Convertible, Standard..... 172.99 set
- 69FN-CVD 1969 Convertible, Deluxe 188.99 set
- 70FN 1970-71 All 181.99 set
- 72FN 1972 All 167.99 set
- 73FN 1973-76 All 175.99 set
- 77FN 1977 All 153.99 set
- 78FN 1978 All 157.99 set
- 79FN 1979 All 157.99 set



ICE-36L

1975-92 Door Handles

Complete door handle assemblies.

ICE-36L	1975-81 LH.....	9.99 ea.
ICE-36R	1975-81 RH.....	9.99 ea.
IDH-82F	1982-92 Fits LH or RH.....	9.99 ea.



IK-482

1977-81 Door Handle Release Escutcheons

Installed on the panel behind the release handle to provide a finishing touch.

IK-482	1977-81.....	29.99 pr.
--------	--------------	-----------



IHQ-4656L

IHQ-1463

Deluxe Door Handles

Excellent quality reproduction door handles.

IHQ-4656L	1967 LH.....	21.99 ea.
IHQ-4656R	1967 RH.....	21.99 ea.
IHQ-1463	1968-69.....	32.99 pr.



IG-101

IG-207

Deluxe Door Grab Handles

Replace your cracked or missing original handles with these OE style reproductions. Add new hardware for a totally fresh look.

IG-101	1968-69 Handle.....	29.99 ea.
IG-207	1968-69 Bezels.....	27.99 pr.
IW-405	1968-69 Screw Set 4pc.....	4.99 kit



IPC-12

Deluxe Door Panel Carpet

Correct 80/20 nylon/rayon blend carpet found on all lower deluxe door panels. Perfect for freshening up your original door panels!

IPC-6701	1967 Black.....	34.95 pr.
IPC-6702	1967 Red.....	34.95 pr.
IPC-6704	1967 Bright Blue.....	34.95 pr.
IPC-6705	1967 Gold.....	34.95 pr.
IPC-6706	1967 Turquoise.....	34.95 pr.
IPC-12	1968-69 Black.....	39.95 pr.
IPC-1202	1968-69 Red.....	34.95 pr.
IPC-1206	1968 Turquoise.....	34.95 pr.
IPC-1208	1968 Medium Blue.....	34.95 pr.
IPC-1209	1968 Ivy Gold.....	34.95 pr.
IPC-1212	1969 Dark Blue.....	34.95 pr.
IPC-1213	1969 Dark Green.....	34.95 pr.



ICE-343

1970-74 Door Handle Assemblies

These correct reproduction inner door handles are OE style to original with escutcheon and mounting bolts. Door handles are available separately.

ICE-343	1970-74 LH w/ Cup.....	39.99 ea.
ICE-342	1970-74 RH w/ Cup.....	39.99 ea.
ICE-70FCL	1970-74 LH w/o Cup.....	19.95 ea.
ICE-70FCR	1970-74 RH w/o Cup.....	19.95 ea.



IDH-1X

IDH-2XL

Deluxe Door Handle Mechanisms

OE style reproduction plated mechanisms.

IDH-1X	1967 Deluxe.....	42.99 pr.
IDH-2XR	1968-69 Deluxe RH.....	39.99 ea.
IDH-2XL	1968-69 Deluxe LH.....	39.99 ea.



IDH-479

IDH-901

Standard Door Handle Mechanisms

OE style reproduction plated mechanisms.

IDH-479	1967 Standard.....	29.99 pr.
IDH-901	1968-69 Standard.....	36.99 pr.



JTE-8235

Door Jamb Vents

Choose from replacement style or OEM style with flaps.

JSS-3026	1967-69 Replacement.....	12.99 ea.
JTE-679	1967-69 OEM Style.....	16.99 ea.
JTE-8235	1970-81 All.....	14.95 ea.

Eddie Motorsports Billet Door Jamb Vents

Billet door jamb vents from Eddie Motorsports will add an awesome pro touring touch to your interior. You can also choose from raw mesh or black mesh. Fill in _ for finish choice. Leave _ blank if you would like natural finish.

MS275-25_	1967-69 Billet Door Jamb Vents.....	97.99 pr.....	121.99 pr.....	132.99 pr.
MS275-27_	1970-81 Billet Door Jamb Vents.....	114.99 pr.....	138.99 pr.....	149.99 pr.

M = Machined, P = Polished,
R = Red, B = Blue, W = White, PR = Purple,
BK = Gloss Black Fusioncoat,
BKA = Gloss Black Anodized,
MB = Matte Black Fusioncoat,
MBA = Matte Black Anodized,
CL = Clear Coat, CA = Clear Anodized

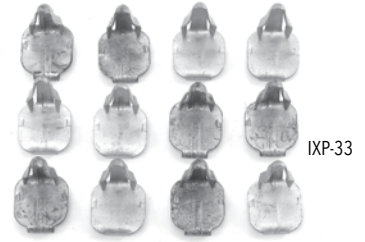

IXP-33

Door Panel Clips

Correct clips for attaching panels.

IXP-33	1967-81 All Clips (12pc.).....	7.99 kit
IXP-471	1975-81 All Clips (12pc.).....	9.95 kit



IXP-370

Door Panel Molding Clips

Correct clips to attach moldings to the door panel.

IXP-370	1972-77 Small.....	2.99 ea.
6 Required per door.		
IXP-371	1972-77 Large.....	3.99 ea.
4 Required per door.		



IXP-18

Door Panel Plugs

Correct plugs for attaching door panel clips. Buy the kit and save!

IXP-18K	Plug Kit 12pc.....	19.10 kit
IXP-18	Plug, All.....	1.99 ea.



IFW-2

Door Panel Washers

Foam washers used under the door panels to seal door handles and window cranks.

IFW-2	1967-81 All.....	6.95 pr.
-------	------------------	----------



MS275-27M

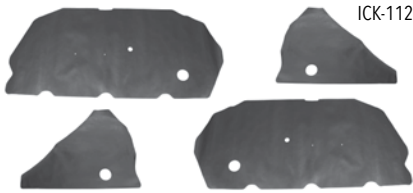

ICK-112

Door Panel Water Shields

Correct pre-cut water resistant paper material

ICK-112	1967 Coupe 4pc	16.99 kit
ICK-112V	1967 Convertible 4pc	11.99 kit
ICK-114	1968-69 Coupe 4pc	13.99 kit
ICK-114V	1968-69 Convertible 2pc	10.99 pr.
ICK-X7	1970-81 All 2pc	11.99 kit



7698543



7698542

1968-69 Inner Door Panel Retainer / Window Guide

Used to support the inner door panels and includes the felt pad used to guide the window when rolling up or down.

7698543	1968-69 Front	18.99 ea.
7698542	1968-69 Rear	19.99 ea.

Note: 2 fronts and 2 rears required per car.



IRP-685



IRP-760

1970-81 Inner Door Panel Retainer Plate

Used to support inner door panels. Center/rear includes correct felt padding

IRP-685	1970-78 Forward Plate	16.99 ea.
IRP-760	1970-79 Center/Rear Retainer	16.99 ea.



MS277-20M

1967-81 Stainless Steel Strikers

Awesome stainless strikers from Eddie Motorsports.

MS277-20M	Door Striker Bolts Machined	47.99 pr.
MS277-20P	Door Striker Bolts Polished	53.99 pr.



ICE-6400



IFF-600

Door Lock Knobs & Ferrules

OE style reproduction door lock knobs & ferrules.

ICF-4411	1967 Chrome Knob	5.99 ea.
IFF-401	1967 Ferrule	6.99 pr.
ICE-6400	1968-81 Chrome Knob	2.95 ea.
IFF-600	1968-81 All Ferrule	1.95 ea.
IFF-700	1970-81 All Ferrule	1.95 ea.



IMB-833

Remote Mirror Bezel

This is an OE style reproduction remote side mirror interior bezel.

IMB-833	1968-81 Standard Interior	29.99 ea.
IMB-450	1968-69 Deluxe Interior	29.99 ea.



KVF-RVT

Vent Window Rivet

Correct rivet for vent window.

KVF-RVT	1967	1.95 ea.
---------	------------	----------



IDP-109

Door Panel Screws

Correct size attaching screw for door panels.

IDP-109	All	0.50 ea.
---------	-----------	----------



4432790



GWS-712

Power Window Switch

Correct OEM style power window switch.

4432790	1967-70 1 Window	39.95 ea.
4432791	1967-70 4 Window	63.95 ea.
GWS-711	1971-81 1 Window	39.95 ea.
GWS-712	1971-81 2 Window	49.95 ea.

IJW-689



Door Jamb Windlace

Correct style windlace in black.

IJW-67	1967	94.99 pr.
IJW-689	1968-69	94.99 pr.

Windlace by the Foot

Replacement style snap on vinyl windlace, sold by the foot. Often used to seal interior rear door jamb edges to sill plates and much more. Featuring authentic vinyl grain texture, positive gripping power and rapid application, this flexible snap-on vinyl trim is ideal for classic car applications.

IJW-PERFOOT	All	1.50 ea.
-------------	-----------	----------

Note: This part is sold by the foot. Ex. Order quantity of 2 to get 2 feet, quantity of 5 to get 5 feet, etc.



IWE-67

Windlace End Caps

Correct molded caps for top edge of rear door panel.

IWE-67	1967	29.95 pr.
--------	------------	-----------



By Palco Industries, Inc.



DT-214

DT-236

DT-218

Dashtop Replacement Dash Covers

This molded plastic dash cover simply fits right over the existing dash to cover unsightly cracks! An easier and more economical alternative to complete dash replacement.

DT-214	1967 All Black	159.95 ea.
DT-215	1968 All Black	159.95 ea.
DT-236	1969 w/o AC Black	159.95 ea.
DT-221	1969 w/ AC Black	159.95 ea.
DT-208	1970-78 w/o AC Black	159.95 ea.
DT-218	1970-78 w/ AC Black	159.95 ea.
DT-216	1979-81 All Black	159.95 ea.

Call for Colors.



TMI-CA0027



TMI-CA0051

TMI Sport Dash Pads

TMI's new Sport Dash Pads for the Camaro hold on to the iconic styling cues that make a Camaro interior so easily recognizable. However, TMI has modernized the original by adding sharper, elongated lines. These dash pads are injection molded foam with a Madrid Grain Vinyl overlay!

TMI Sport Dash Pads

TMI-CA0001	1967 Black	340.99 ea.
TMI-CA0007	1968 Black	340.99 ea.
TMI-CA0013	1969 w/o AC Black	340.99 ea.
TMI-CA0019	1969 w/ AC Black	340.99 ea.

TMI Sport R Dash Pads

Black vinyl with red stitching.

TMI-CA0027	1967 Black	390.99 ea.
TMI-CA0033	1968 Black	390.99 ea.
TMI-CA0039	1969 w/o AC Black	390.99 ea.
TMI-CA0045	1969 w/ AC Black	390.99 ea.

TMI Sport X Dash Pads

Black vinyl with red stitching and silver grommets red inserts.

TMI-CA0051	1967 Black	487.99 ea.
TMI-CA0069	1968 Black	487.99 ea.
TMI-CA0087	1969 w/o AC Black	487.99 ea.
TMI-CA0105	1969 w/ AC Black	487.99 ea.

TMI Sport XR Dash Pads

Black vinyl and suede with red stitching and silver grommets red inserts.

TMI-CA0123	1967 Black	543.99 ea.
TMI-CA0141	1968 Black	543.99 ea.
TMI-CA0159	1969 w/o AC Black	543.99 ea.
TMI-CA0177	1969 w/ AC Black	543.99 ea.

This item ships oversize 2. No Volume Discount. Call for color options.

DASH PADS



ICI-690E

1969 OEM Style Dash Pad

This is an original equipment quality reproduction padded dash featuring the original correct grain. Constructed of urethane, with a foam over a plastic spine and features a one piece steel reinforcement for a long lasting appearance and quality fit. This dash will fit and function better than any other replacement dash on the market.

ICI-690E 1969 w/o Air Conditioning Black 399.99 ea.

Dash Pads

1967-69 dashes feature solid fiberglass cores surrounded by vinyl wrapped foam to assure you the best look and fit on the market! All of the factory colors are available and will match your new PUI colored interior exactly.

1970-81 dashes are crafted from urethane materials for an original appearance and fit. You will get the same quality look and feel of an original dash pad without the headaches of sun damage.



ICI-85810

ICI-85810 1967 Black 169.95 ea.



ICI-85910

ICI-85910 1968 Black 299.95 ea.



ICI-86110AC

ICI-86110 1969 w/o Air Conditioning Black 299.99 ea.
ICI-86110AC 1969 w/ Air Conditioning Black 299.95 ea.



ICI-801

ICI-801 1970-78 w/o Air Conditioning Black 391.99 ea.



ICI-901

ICI-901 1970-78 w/ Air Conditioning Black 391.99 ea.



ICI-79

ICI-79 1979-81 All Black 579.99 ea.



ICI-82

ICI-82 1982-92 All Black 605.99 ea.

Ask your sales rep for color selection. Ships Oversize.

DASH PAD ACCESSORIES



ICI-674



ICI-78K



ICI-312

Dash Clips

Correct dash mounting clips.

ICI-674 1968 Dog Leg Clips 11.99 pr.
ICI-78K 1969 All 6pc 14.95 kit
ICI-311 1970-78 Original Dash 3pc 9.99 kit
ICI-310 1970-78 Repro Dash 6pc 13.99 kit
ICI-312 1979-81 All 3pc 14.99 kit



IK-156

1968 Dash Pad Trim Molding

Correct reproduction of the original three piece factory dash molding designed for 1968 Camaros that originally included a dash molding.

IK-156 1968 3pc 129.99 set
Will not work on reproduction dash pads.



IK-0046

1969-70 Astro Ventilation Emblem

OE style die cast reproduction emblem.

IK-0046 1969-70 13.99 ea.



IK-11DF

IK-544

Defroster Vent

OE style reproduction under dash defroster vent assembly.

IK-11DF 1967-68 149.99 ea.
IVA-69 1969 149.99 ea.
IK-544 1982-92 All Side Vents 18.99 pr.



IK-850

1967-68 Dash Vent Balls

OE style reproduction chrome vent balls with correct accenting.

IK-850 1967-68 Vent Ball 18.95 ea.

Featured on 1967 A/C cars & 1968 cars w/ Astro Vents



IK-742

IK-744

1967-68 Dash Vent Bezels

OE style reproduction correct bezels which house the dash vent balls. Available in chrome or black (paint to match).

IK-742 1967-68 Chrome RH 19.99 ea.

IK-741 1967-68 Chrome LH 19.99 ea.

IK-744 1967-68 Black RH 19.99 ea.

IK-743 1967-68 Black LH 19.99 ea.

Featured on 1967 A/C cars & 1968 cars w/ Astro Vents



IW-566

1967-68 Dash Vent Bezel Retainers

This part is required to retain the dash vent ball bezel to the dash assembly. Includes screws.

IW-566 1967-68 6.99 ea.

Featured on 1967 A/C cars & 1968 cars w/ Astro Vents



IM-23

1967-68 Dash Vent Seals

Correct seals for dash side vents.

IM-23 1967-68 3.95 pr.

Featured on 1967 A/C cars & 1968 cars w/ Astro Vents



IW-564K

1967-68 Dash Vent Knob and Ferrule Set

Correct reproductions available with clear or black acrylic ferrules with black knobs.

IW-564K 1967-68 Clear 15.99 kit

IW-564BK 1967-68 Black 15.99 kit

Featured on 1967 A/C cars & 1968 cars w/ Astro Vents



IK-189

1967-68 Dash Vent Ball Retainer

The vent ball retainer is a necessary part designed to attach the vent duct to the vent bezel assembly.

IK-189 1967-68 11.99 ea.

Featured on 1967 A/C cars & 1968 cars w/ Astro Vents



IK-289

Side Vent Shutoff

OE style reproduction shutoff assembly which installs behind the dash air vent bezel.

IK-289 1967-68 RH 40.99 ea.

IK-290 1967-68 LH 40.99 ea.

Featured on 1967 A/C cars & 1968 cars w/ Astro Vents



IC-6

Dash Vent Seal Kit

Reseal your leaky Astro Ventilation System with this complete kit! Includes all of the correct die stamped sponge rubber seals needed.

IC-6 1967-68 18.95 kit

IC-7 1969 24.99 kit



IK-11AD

1968 Astro Vent Duct

New correct reproduction for non-AC models.

IK-11AD 1968 32.95 ea.

Note: Two required per car.



IVS-528

1968-69 Astro Vent Duct Screws

These screws attach the astro vent duct to the cowl.

IVS-528 1968-69 Screws 7.99 kit

VENTS

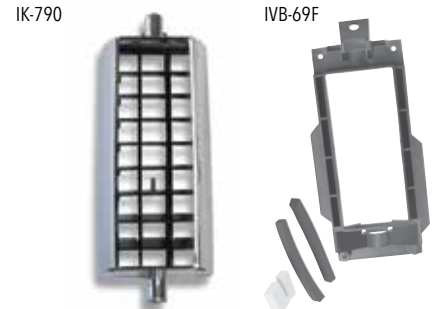

IK-790

IVB-69F

1969 Side Air Vent

Correct injection molded reproduction bezel and vent.

IK-790 1969 Vent 24.99 ea.

IVB-69F 1969 Bezel RH 24.95 ea.



IVC-69F

1969 Air Vent Control

Correct air vent control complete with vent and bezel.

IVC-69FL 1969 LH 89.99 ea.

IVC-69F 1969 RH 99.99 ea.



IK-668

IK-667

1970-81 Side Air Vents without A/C

OE style reproduction injection molded air vents complete with vent bezels and vent deflectors.

IK-667 1970-81 LH w/o A/C 76.99 ea.

IK-668 1970-81 RH w/o A/C 76.99 ea.



IK-927

1970-78 Dash Vent Bezel

Injection molded vent bezel which mounts between the inner air duct and the outlet air deflector.

IK-927 1970-78 43.99 ea.

VENTS *continued*



IK-154



IK-269



IK-270



IK-543

Center Air Vents A/C

Correct center air conditioning vents.

IK-154	1967-68 Cast 2pc.....	59.99 set
IK-269	1969	88.99 ea.
IK-270	1970-78	83.99 ea.
IK-543	1979-81	43.99 ea.



IK-8408

1970-81 Side Air Vents with A/C

OE style reproduction injection molded air vents complete with vent bezels and vent deflectors.

IK-8407	1970-81 LH w/ A/C.....	89.99 ea.
IK-8408	1970-81 RH w/ A/C	89.99 ea.

INSTRUMENT PANELS



IK-278

1967-68 Dash Instrument Panel

Injection molded reproduction manufactured to exact factory specifications with correct bright chrome finish around bezel as original.

IK-278	1967-68 All Panel.....	108.99 ea.
IDC-67F	1967-68 Mounting Clips to Dash 2pc.....	6.99 pr.



IK-322

1969 Dash Instrument Panel

Excellent reproduction manufactured from new tooling and features hot stamped chrome lettering surrounding the radio, lighter, wipers and air vent opening with the word Camaro in script as original.

IK-322	1969 All Panel.....	229.95 ea.
IDC-69F	1969 Mounting Clips to Dash 10pc.....	16.99 kit



ILD-718

1970-81 Lower Dash Instrument Panel

OE style reproduction featuring the correct grain as original.

ILD-718	1970-81	196.99 ea.
---------	---------------	------------

Note: Requires slight modification to radio holes for 1976-81.



ISC-011

1970-78 Lower Steering Column Panel

This is the lower plastic steering column cover which installs under the steering column and acts as a trim piece to finish off the bottom of the dash.

ISC-011	1970-78 All	120.99 ea.
---------	-------------------	------------



IGH-020

1970-81 Instrument Cluster Case

OE style reproduction injection molded instrument cluster case.

IGH-020	1970-81 w/ Gauges.....	118.99 ea.
IGH-021	1970-78 w/o Gauges.....	116.99 ea.
IGH-020	1979-81 w/o Gauges.....	118.99 ea.



IK-488



IK-645

1970-78 Dash Instrument Panel

Excellent quality reproductions with correct grains. The 1970-72 panel features chrome trim as original. The 1976-78 woodgrain panel is designed after the one installed in deluxe interiors.

IK-488	1970-72 w/ Trim.....	170.99 ea.
IK-645	1976-78 Woodgrain	243.99 ea.

Lettering not included on IK-488. May be installed on all models but requires a 1970-72 wiper switch.



ILA-584



ILA-346

1970-81 Dash Lens Assembly

Injection molded reproduction of the original instrument cluster lens assembly for models with or without gauges

ILA-584	1970-78 w/o Gauges	119.99 ea.
ILA-802	1979-81 w/o Gauges	124.99 ea.
ILA-346	1970-78 w/ Gauges	129.99 ea.
ILA-370	1979-81 w/ Gauges	126.99 ea.



IK-093

1969 Center Dash Bezel

Correct injection molded reproduction dash bezels for center clock or center dash fuel gauge. The lens is included and the hole is pre cut. Lenses are also available separately.

IK-093	1969 Clock	30.99 ea.
IK-094	1969 Fuel.....	27.99 ea.
IL-27	1969 Clock Lens Only	11.99 ea.
IL-28	1969 Fuel Lens Only	9.99 ea.

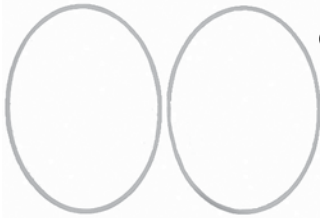

CT-665

1967-68 Instrument Panel Chrome Applique

High tech, ultra thin chrome mylar trim edging for restoring your otherwise nice original dash.

CT-665	1967-68	22.99 kit
--------	---------------	-----------



IL-526



IL-68D



IL-85

Dash Lenses

OE style reproduction of the often scratched or damaged original lenses.

IL-526	1967 All	32.99 ea.
IL-68D	1968 w/o Console Gauge.....	39.99 ea.
IL-68C	1968 w/ Console Gauge.....	39.99 ea.
IL-85	1970-78 All	59.99 ea.



GPC-68T

Printed Circuit Boards

OE style reproduction circuit board.

with Factory Gauges

GPC-67	1967	72.95 ea.
GPC-67	1967 w/ Tach 1968 w/o Tach	72.95 ea.
GPC-68	1968 w/ Tach	79.99 ea.
GPC-676	1970-81	69.95 ea.

with Warning Lights

GPC-67W	1967-69	72.95 ea.
GPC-739W	1970-79	72.95 ea.
GPC-801W	1980-81	72.95 ea.



IK-84

1969 Speedo/Fuel Lens Assemblies

OE style reproduction lens assemblies to replace your cracked or hazed originals.

IK-84	1969 Fuel.....	59.99 ea.
IK-24S	1969 Speedometer.....	59.99 ea.



ISP-69F

1969 Instrument Socket Plate

Attaches to the back of the instrument housing above the gauges to provide access to mount the instrument panel lamp sockets.

ISP-69F	1969 All	23.99 ea.
---------	----------------	-----------

Note: Two required per car.

GAUGES



6457934

1967 Dash Fuel Gauge

OE style reproduction fuel gauge with RH turn signal and warning light provisions. For use on all models not equipped with an in dash tach.

6457934	1967	197.99 ea.
---------	------------	------------

No Volume Discount



6431002

1968 Dash Fuel Gauge

OE style reproduction fuel gauge with RH turn signal and warning light provisions. For use on all models not equipped with an in dash tach.

6431002	1968	225.99 ea.
---------	------------	------------

No Volume Discount



6431172

1969 Dash Fuel Gauge

OE style reproduction fuel gauge featuring correct face plate with AC Delco decal. For use on all models not equipped with an in dash tach.

6431172	1969	149.99 ea.
---------	------------	------------

No Volume Discount



6431506

1970-78 Fuel Gauge

OE style reproduction fuel gauge with correct markings for all models with gauges.

6431506	1970-78	98.99 ea.
---------	---------------	-----------

No Volume Discount



IK-178

1969 Center Dash Fuel Gauge

High quality reproduction of the original center dash fuel gauge which was originally equipped on models with a tachometer and without console gauges.

IK-178	1969	154.99 ea.
--------	------------	------------

No Volume Discount



IQ-464

1969 Center Dash Clock

OE style reproduction center dash clock for models equipped with RPO code U35 clock or U17 special instrumentation. Manufactured with quartz movement for accuracy and cosmetically correct once installed.

IQ-464	1969	149.99 ea.
--------	------------	------------

No Volume Discount

GAUGES *continued*



IQ-70

1970-78 In Dash Clock

OE style reproduction in dash clock for models with gauges. Features correct markings and quartz movement for accuracy.

IQ-70 1970-78 199.99 ea.
No Volume Discount



6473741

1970-78 Amp/Volt Gauge

Reproduction amp/volt gauge featuring correct markings. Calibrated and ready to install.

6473741 1970-75 Amps 98.99 ea.
6474343 1976-78 Volt 94.99 ea.
No Volume Discount



6489856

1970-78 Temp Gauge

OE style reproduction water temperature gauge with correct markings. Calibrated and ready to install.

6489856 1970-78 109.99 ea.
No Volume Discount



6480794

1967 Speedometer

OE style reproduction standard 120 mph speedometer. Correctly calibrated and ready to install. Available with or without U15 speed warning indicator.

6480794 1967 249.99 ea.
6480796 1967 w/ Speed Warning 289.99 ea.
No Volume Discount



6481843

1968 Speedometer

OE style reproduction standard 120 mph speedometer. Correctly calibrated and ready to install. Available with or without U15 speed warning indicator.

6481843 1968 258.99 ea.
6481845 1968 w/ Speed Warning 289.99 ea.
No Volume Discount



IQ-111

1969 Speedometer

OE style reproduction standard 120 mph or 140 mph COPO speedometer. Correctly calibrated and ready to install. Available with or without U15 speed warning indicator.

6482887 1969 120 232.99 ea.
6482888 1969 120 w/ Spd Wrng 259.99 ea.
IQ-111 1969 140 COPO 199.99 ea.
6492576 1969 140 COPO w/ Spd Wrng 219.99 ea.
No Volume Discount



8987263

1970-78 Speedometer

OE style reproduction speedometers with all correct markings.

8987263 1970-78 130 MPH 297.99 ea.
6497236 1970-74 150 MPH 319.95 ea.
No Volume Discount



6468909

1967 Tachometer

OE style reproduction tachometers to replace your original.

6468909 327 5000 RPM 329.99 ea.
6468910 350, 396/325 5500 RPM 309.99 ea.
6468911 Z/28, 396/375 6000 RPM 329.95 ea.
No Volume Discount



6468713

1968 Tic-Toc Tachometer

OE style reproduction Tic-Toc tachometers to replace your original.

6468713 327, 350 5500 RPM 359.99 ea.
6468714 396/325-350 5000 RPM 359.99 ea.
6468715 Z/28, 396/375 6000 RPM 359.99 ea.
No Volume Discount



6469381

1969 Tachometer

OE style reproduction tachometers with correct faceplates and AC Delco decals.

6469381 SS350 5000 RPM 179.99 ea.
6469384 396/375 6000RPM 179.99 ea.
6469384 Z/28 6000 RPM 179.99 ea.
6469382 Early Z/28 5500 RPM 179.99 ea.
6469382 396/325-350 5500 RPM 179.99 ea.
6469383 396/375 6000 RPM 174.99 ea.
No Volume Discount



5657040

1970-78 Tachometer

OE style reproduction tachometers with correct markings and a lens for the low oil pressure warning light. Correct for all 1970-74 without Z/28 or 396 and all 1975-78 models.

5657040 5000 RPM 299.99 ea.
No Volume Discount



EHT-335

Dixco Style Hood Tach

These were used on several aftermarket applications for super cars including Yenko and Motion. White, paint to match.

EHT-335 1967-92 User Sets Red Line 199.95 ea.

Gauges *continued*



RT80SLF

Classic Rocket Tach

Retro style, with color changing rocket.

RT80SLF 1967-92 6500 Red Line 184.99 ea.

Gauge Accessories



6454841

ISW-2148

Speed Warning Cables

High quality reproduction of the control cable used with the desirable and highly sought after RPO code U15 (Speed Warning Indicator).

6454841 1967-68 Cable 29.99 ea.
6476813 1969 Cable 29.99 ea.
ISW-2148 1969 Cable Bracket 24.95 ea.



IRC-006

Speedometer Cable Retaining Clip

Holds the cable to the back of speedometer.

IRC-006 1969-81 All 5.99 ea.



IN-60

Clock Reset Knob

Replacement clock reset knob kit including correct retaining nut. Measures 5/16" long. Includes 2 knobs for early or late cars.

IN-60 1967-81 All 11.99 ea.

No Volume Discount



ICD-69U

ICD-69L



1969 Center Clock/Fuel Clips

Correct special clips to mount center dash clock or fuel gauge.

ICD-69U Upper Clips 17.95 pr.
ICD-69L Lower Clips w/ Screws 33.95 kit



IDL-69CD

1969 Center Dash Diffuser

Correct diffuser replaces original.

IDL-69CD 1969 Diffuser 4.95 ea.



FHB-115

Speedometer Cable Clip

OE style reproduction of the speedometer cable clip that mounts on the firewall and transmission hump.

FHB-115 1967-69 All 11.95 ea.



GAC-6768

1967-68 High Beam Indicator

This is a reproduction headlamp hi-beam indicator bulb housing, red lens and ground strap. Mounts on the upper portion of the rear section of the plastic instrument carrier. The ground strap is instrumental in grounding the hi-beam indicator light and gauge cluster assembly. Includes mounting screws. Bulb and wiring are not included.

GAC-6768 All 49.99 set



IDL-68GT



IDL-68OB



IDL-67FB

Indicator Lenses

Replace your missing original indicator lenses with these correct reproductions.

IDL-67FB 1967 Fuel / Brake 12.99 ea.
IDL-68OB 1968 Oil / Brake 9.95 ea.
IDL-68GT 1968 Gen / Temp 9.95 ea.



DT-200008



DT-200016

LED Dash Bulbs

A simple direct replacement for your original 194 style dash light bulbs. Excellent to increase brightness and reduce heat and power.

DT-200008 194 Red LED Bulbs 15.95 pr.
DT-200009 194 Amber LED Bulbs 15.95 pr.
DT-200016 194 White LED Bulbs 16.95 pr.



ITT-001

1970-78 Gauge Mounting Plate

Correct mounting plate for fuel gauge and volt gauge.

ITT-001 1970-78 14.99 ea.

No Volume Discount



RTX-70C-CAM-X

RTX-69C-CAM-X

RTX-67C-CAM-X

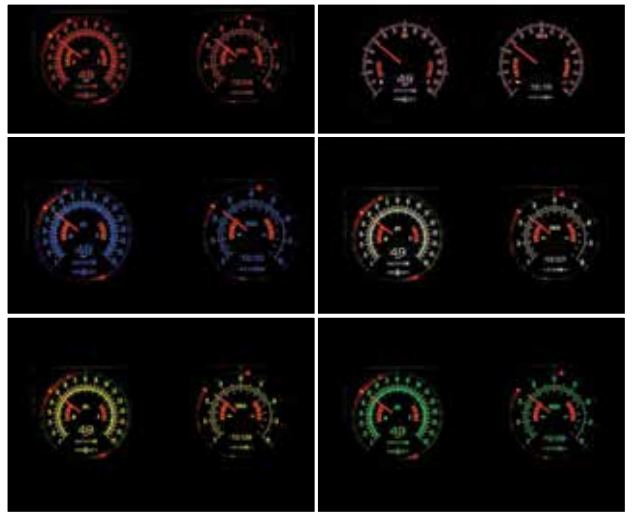

Dakota Digital RTX Gauge Kits

Designed after stock Camaro clusters, these all-new packages look like a simple speed/tach combo until you turn the key, then four auxiliary readings appear! Oil pressure, coolant temperature, fuel and volts are comprised of LED bars; invisible to the average observer but front and center for the driver. Each pod has a TFT message center for additional information at your finger tips. Although the graphic styles vary between 1967 and 1968, the systems will interchange between the years, so choose your preferred or period-correct version! Will fit directly into stock or reproduction gauge bezels, sold separately. The RTX series is the latest from Dakota Digital, focusing on retaining that stock look without sacrificing the late-model features you love. Every effort has been put forth to incorporate OEM design elements regarding the layout, face styling and indicators. A casual glance may dismiss these as original equipment, but once you hit the switch and the LED backlighting comes on in your favorite color scheme, all doubts will be removed. Starting from scratch, CNC machined housings are filled with electronics designed and built in-house, helping Dakota Digital once again raise the bar for aftermarket instrumentation. The high-definition TFT message centers can be fully configured to display just about any piece of information needed or just leave the vintage-looking tumbler odometer on the screen for a totally stock appearance. As you've come to expect from Dakota Digital, the RTX series utilizes a central control box to make installation and setup as easy as possible. Bezel not included, shown for visual/presentation purposes. The RTX system uses an OEM or reproduction style bezel.



RTX-67C-CAM-X	1967.....	1230.99 kit
RTX-68C-CAM-X	1968.....	1230.99 kit
RTX-69C-CAM-X	1969.....	1230.99 kit
RTX-70C-CAM-X	1970-81.....	1230.99 kit

No Volume Discount



HDX-67C-CAM-S

HDX-70C-CAM-S



HDX-69C-CAM-K



Dakota Digital HDX Gauge Kits

Ushering in a new era of muscle machines, Camaros have long been turned into hot rods. Keep the tradition alive and bring yours up to spec with this direct-fit instrument system! It attaches directly to a stock or reproduction bezel (available separately) and supplies you with six analog gauge sweeps and a pair of high visibility TFT message centers. Available with your choice of black or silver alloy gauge-face styling, each HDX system allows the user to select independent illumination colors for the gauge readings and needles, as well as the message centers. Calibration and personal settings are manipulated with the built-in, capacitive-touch buttons or the available Bluetooth App. for Apple and Android devices. Each needle hub is black nickel plated spun-aluminum to match the buttons. All HDX instrument systems feature dead-faced indicators (turn signals, high beam, check engine, cruise control, parking brake, plus two user-definable) and a red, settable warning light for each gauge. With our central control box, installation is greatly simplified with vehicle-harness sourced signals and supplied, solid state sending units connecting cleanly to their respective terminals.



HDX-67C-CAM-S	1967-68 Silver Alloy Face	1295.95 ea.
HDX-67C-CAM-K	1967-68 Black Alloy Face.....	1295.99 ea.
HDX-69C-CAM-S	1969 Silver Alloy Face.....	1295.95 ea.
HDX-69C-CAM-K	1969 Black Alloy Face	1295.95 ea.
HDX-70C-CAM-S	1970-78 Silver Alloy Face	1295.95 ea.
HDX-70C-CAM-K	1970-78 Black Alloy Face.....	1295.95 ea.

No Volume Discount.

Dakota Digital Instrument Clusters

Dakota Digital Series III instrument systems offer the latest technology and features for your custom vehicle. High brightness vacuum fluorescent displays provide a lifetime of trouble free use while offering increased accuracy and features! For a full list of features visit ss396.com or ask your sales rep.



VFD3-67C-CAM-B



VHX-69C-CAM-C-B

1967-68 Camaro Dakota Digital Instrument Cluster VFD3 System

Fits directly into existing bezel. Choose from blue or teal numbers, MPH or KPH and degrees Fahrenheit or Celsius.

- VFD3-67C-CAM-B Blue, MPH, Fahrenheit..... 593.99 kit
- VFD3-67C-CAM-B-K Blue, KPH, Celsius..... 593.99 kit
- VFD3-67C-CAM-T Teal, MPH, Fahrenheit..... 593.99 kit
- VFD3-67C-CAM-T-K Teal, KPH, Celsius..... 593.99 kit

Does not include bezel. No Volume Discount



VHX-67C-CAM-S-R

1967-68 Camaro Dakota Digital VHX System

The new VHX system will modernize your ride with the latest technology and styling. Attaching directly to the back side of the stock instrument housing, the fitment couldn't be simpler. Fully lit needles, backlit faces and highly visible LCD message centers are a few of the things that you can see which set the VHX Series apart from yesterday's traditional approach to instrumentation.

- VHX-67C-CAM-S-R Silver Alloy, Red Numbers 755.99 kit
- VHX-67C-CAM-S-B Silver Alloy, Blue Numbers 755.99 kit
- VHX-67C-CAM-C-R Carbon Fiber, Red Numbers..... 755.99 kit
- VHX-67C-CAM-C-B Carbon Fiber, Blue Numbers 755.99 kit

Does not include bezel. No Volume Discount



VFD3-69C-CAM-B

1969 Camaro Dakota Digital Instrument Cluster VFD3 System

Includes new reproduction bezel. Choose from blue or teal numbers, MPH or KPH and degrees Fahrenheit or Celsius.

- VFD3-69C-CAM-B Blue, MPH, Fahrenheit..... 783.99 kit
- VFD3-69C-CAM-B-K Blue, KPH, Celsius..... 783.99 kit
- VFD3-69C-CAM-T Teal, MPH, Fahrenheit..... 783.99 kit
- VFD3-69C-CAM-T-K Teal, KPH, Celsius..... 783.99 kit

No Volume Discount

1969 Camaro Dakota Digital VHX System

The VHX system will modernize your ride with the latest technology and styling. Attaching directly to the back side of the stock instrument housing, the fitment couldn't be simpler. Fully lit needles, backlit faces and highly visible LCD message centers are a few of the things that you can see which set the VHX Series apart from yesterday's traditional approach to instrumentation.

- VHX-69C-CAM-S-R Silver Alloy, Red Numbers 755.99 kit
- VHX-69C-CAM-S-B Silver Alloy, Blue Numbers 755.99 kit
- VHX-69C-CAM-C-R Carbon Fiber, Red Numbers..... 755.99 kit
- VHX-69C-CAM-C-B Carbon Fiber, Blue Numbers 755.99 kit

Does not include bezel. No Volume Discount



VFD3-70C-CAM-N-B

1970-81 Camaro Dakota Digital Instrument Cluster VFD3 System

Includes dash housing which fits into bezel. Choose from blue or teal numbers, MPH or KPH and degrees Fahrenheit or Celsius.

- VFD3-70C-CAM-N-B Blue, MPH, Fahrenheit..... 755.99 kit
- VFD3-70C-CAM-N-B-K Blue, KPH, Celsius..... 755.99 kit
- VFD3-70C-CAM-N-T Teal, MPH, Fahrenheit..... 755.99 kit
- VFD3-70C-CAM-N-T-K Teal, KPH, Celsius..... 755.99 kit

Does not include bezel. No Volume Discount



VHX-70C-CAM-S-B

1970-81 Camaro Dakota Digital VHX System

The new VHX system will modernize your ride with the latest technology and styling. Attaching directly to the back side of the stock instrument housing, the fitment couldn't be simpler. Fully lit needles, backlit faces and highly visible LCD message centers are a few of the things that you can see which set the VHX Series apart from yesterday's traditional approach to instrumentation.

- VHX-70C-CAM-S-R Silver Alloy, Red Numbers 755.99 kit
- VHX-70C-CAM-S-B Silver Alloy, Blue Numbers 755.99 kit
- VHX-70C-CAM-C-R Carbon Fiber, Red Numbers..... 755.99 kit
- VHX-70C-CAM-C-B Carbon Fiber, Blue Numbers 755.99 kit

Does not include bezel. No Volume Discount



BIM-01-2

SEN-04-5



SEN-20-3

BIM-03-1

BIM Expansion Modules

These BIM modules work with any VFD3 or VHX system to expand features.

OBDDII Interface

Allows you to plug directly into the engine diagnostic port, extracting engine data from the OBDDII computer (ECU). Outputs speed, tachometer, engine temp, intake air temp*, trans temp*, ambient air temp* and gear position*.

- BIM-01-2 OBDDII Interface 94.99 ea.

*If data is available from ECM.

Pressure Module

Allows you to add up to 3 additional pressure readings to your VFD3 or VHX system*.

Utilizes solid state pressure senders for phenomenal accuracy.

- BIM-03-1 Pressure Module..... 69.99 ea.
- SEN-03-9 0-300 PSI Pressure Sender 42.99 ea.
- SEN-03-8 0-100 PSI Fuel Pressure Sender..... 75.99 ea.
- SEN-03-9 0-300 PSI Air Pressure Sender 42.99 ea.
- SEN-09-6 30Hg / 80 PSI Vacuum / Boost Sender . 118.99 ea.
- SEN-23-2 0-2000 PSI NOS Pressure Sender 118.99 ea.

*Senders are not included.

Temperature Module

Allows you to add up to 3 additional temperature readings to your VFD3 or VHX system (generic temp, water temp, oil temp, trans temp, differential temp)*.

- BIM-04-1 Temperature Module..... 66.99 ea.
- SEN-04-5 Temperature Sender, 1/8" NPT 0-320F 18.99 ea.
- 140023 NPT Bushing Kit, 1/8" to 1/4", 3/8", 1/2" 9.95 ea.

*Senders are not included. Order one sender per reading.

Voltage / Current Module

Allows you to display up to 2 additional volt readings* or a combination of 1 volt and 1 current reading*.

- BIM-05-1 Voltage/Current Module 85.99 ea.
- SEN-20-3 Amp Current Sender..... 90.99 ea.

*Voltage reading is included in module. Current reading requires sender.

Dakota Digital Instrument systems are normally shipped from the factory with "0" miles on the odometer. If you would like mileage added to the odometer, this can be done at the factory for a charge of \$20. Please contact Ground Up to arrange this service.



**CLASSIC
INSTRUMENTS**



ANCAM67



ATCAM67



AWCAM67



American Nickel



American Tradition



Velocity Black



Velocity White



Classic White



Hot Rod



G-Stock



All American



Vintage



SG



Traditional



White

Classic Instruments 1967-68 Camaro Gauges

Add a totally custom yet vintage look to your interior with these gauges from Classic Instruments. These gauges include a new reproduction dash bezel. Includes 140 MPH speedo (Velocity Series 160 MPH), 8,000 RPM tachometer (Velocity Series 10,000 RPM), Quad Cluster (Fuel 0-90 ohms, water temp, oil pressure, volts), integrated turn and high beam indicators and illumination for night time driving. Gauges are wired and come with sending units for installation.

ANCAM67	1967-68 All American Nickel Series.....	1099.99 kit
ATCAM67	1967-68 All American Tradition Series.....	1099.99 kit
AWCAM67	1967-68 All American Series.....	1099.99 kit
GSCAM67	1967-68 G/Stock Series.....	959.99 kit
HRCAM67	1967-68 Hot Rod Series.....	959.99 kit
WHCAM67	1967-68 Camaro White Hot Series.....	959.99 kit
CWCAM67	1967-68 Classic White.....	959.99 kit
SGCAM67	1967-68 SG Series.....	959.99 kit
TRCAM67	1967-68 Traditional Series.....	959.99 kit
VTCAM67	1967-68 Vintage Series.....	959.99 kit
VSCAM67	Velocity Series Black.....	959.99 kit
VSWCAM67	Velocity Series White.....	959.99 kit

Includes new reproduction dash bezel. No Volume Discount



SN81

SkyDrive GPS Speedometer Sensor

Calibrate your speedometer in less than a minute and you don't even have to leave your driveway! SkyDrive is the worlds most accurate electronic speedometer sending unit. No need for ECU converters or pulse signal generators screwed into your transmission. The new SkyDrive uses GPS satellite signals to operate your electronic speedometer. It updates 10 times per second and with one push of a button it's ready to go!

SN81 SkyDrive259.99 ea.
Note: Works with all Classic Instruments kits as well as any other manufacturer's electronic speedometer.



FSU-1000

Electronic Speedometer Sender

This speedometer sending unit is required for correct operation of your electronic speedometer.

FSU1000 1967-8189.95 ea.
No Volume Discount.
Mechanical gauges do not require this sender.

LS Motor Installation Kit

This kit includes the required sensor adapters for the oil pressure gauge and water temperature gauges. As well as a 10K resistor for the tachometer. The specialized instruction manual, fittings, sensor and electrical component packaged in this kit make the instrument installation on your GM LS based engine simple and straight forward.

5284 LS Motor Installation Kit.....59.95 kit
No Volume Discount



5289

GPS Speedometer Interface Module

This Auto Meter GPS speedometer interface module can turn any electronic speedometer into a GPS speedometer with just the push of a button. It offers plug and play functionality with any Auto Meter electronic speedometer and simple one-button, 10-second calibration for nearly every other electronic speedometer on the market. It features IP67 construction and is fully sealed against water and dust. It includes a fully sealed and paintable magnetic micro antenna and a lightning-fast 10 Hz sampling rate.

5289 GPS Speedo Interface Module236.95 ea.



PRO SHOP™ Series

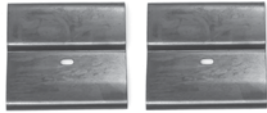

IK-206



IQ-331



IK-8301



IK-524

1969 Dash Grab Handle Kit

Replace your original dash grab handle or upgrade to this option with this complete kit and save! This kit includes trim plate, grab handle, bezels, emblem, mounting plate and hardware.

IK-524KIT 1969 All 125.96 kit

1969 Dash Grab Handle

OE style reproduction dash grab assist handle featuring correct grain.

IK-8301 1969 All 36.99 ea.

1969 Dash Grab Handle Retainer

OE style reproduction of the instrument panel molding located above the glove box door area on the dash with mylar trim.

IK-524 1969 All 24.99 ea.

1969 Dash Grab Handle Bezels

Excellent quality triple chrome plated bezels used to mount the dash grab handle to the dash panel.

IQ-331 1969 All 21.99 pr.

1969 Dash Panel Emblem

Original style reproduction dash panel molding emblem which applies directly above the glove box door.

IK-880 1969 All 25.99 ea.

1969 Dash Grab Handle Retainers

Correct backing plates used to secure the dash grab handle.

IK-206 1969 All 29.99 pr.

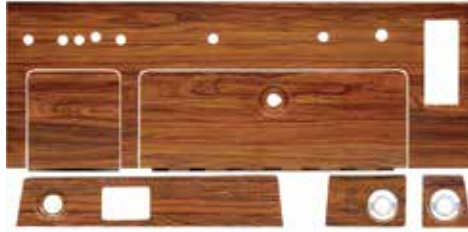

IK-153KIT

1969 Cherrywood Dash Trim Kit

Give your dash it's original luster back by replacing your faded or worn out original Cherrywood Dash set with this OER reproduction kit. Designed to cover the dash area on 1969 Camaro models with Special Interior Group (Z23) or Custom Interior (Z87) packages. Kit includes the dash plate (dash molding and emblem are attached to this area and holes are provided for installation as shown), glove box door, ash tray section, radio plate and windshield wiper plate.

IK-153KIT 1969 All 229.99 kit
Not eligible for volume discount.



IK-153C

1969 Cherrywood Dash Panel

Authentic reproduction of the original Cherrywood dash plate used to cover up the dash panel, ash tray door and glove box door. This is an excellent replacement for your original plate or makes for a nice upgrade if your Camaro did not originally come with this option.

IK-153C 1969 All 207.99 set



IK-152C

1969 Cherrywood Radio Bezels

OE style reproduction Cherrywood radio bezels which will match your new Cherrywood dash panel.

IK-152C 1969 All 32.99 pr.



IWP-71C

1969 Cherrywood Wiper Plate

OE style reproduction Cherrywood wiper plate which will match your new Cherrywood dash panel.

IWP-71C 1969 All 19.99 ea.



IK-204

Center Dash Panels

Excellent reproduction center dash panels available in either correct black pebblegrain or walnut woodgrain. These will give the ultimate finishing touch to your dash!

IK-202	1967-68 Black w/o AC	59.99 ea.
IK-203	1967-68 Black w/ AC	59.99 ea.
IK-204	1968 Walnut w/o AC	79.99 ea.
IK-205	1968 Walnut w/ AC	79.99 ea.
IK-380B	1967-68 Radio Delete w/o AC	59.99 ea.
IK-380C	1967-68 Black Radio Delete	59.99 ea.



IK-524CLIP

Dash Panel Molding Clip

Reproduction of the aluminum clip used to attach the dash panel molding located above the glove box.

IK-524CLIP 1969 All 2.99 ea.
Sold individually, 3 required.



IW-219

Center Dash Panel Retainer

Correct retainer which holds the center dash panel to the dash.

IW-219 1967-68 All 6.99 ea.



TRIM-HL-F



TRIM-IGN



TRIM-GB

Interior Dash Tools

Handy tools for easily removing and installing dash nuts.

TRIM-HL-F	1967-68 Headlight/Wiper Nut	12.95 ea.
TRIM-HL	1969-72 Headlight Nut	12.95 ea.
TRIM-IGN	1967-68 Ignition Bezel Nut	11.95 ea.
TRIM-GB	1969-81 Glove Box Nut	12.95 ea.

ASH TRAY



IC-122

1967 Dash Ash Tray

Featuring correct grains and finishes as original.

IC-122 1967 Black Grain49.99 ea.



IC-122K

1967-68 Dash Ash Tray Bracket

OE style reproduction of the original bracket to restore smooth operation of ash tray receiver.

IC-122K 1967-68 All24.99 ea.



IAT-143A



IAT-144W

1968-69 Dash Ash Tray

Excellent reproduction of the original dash ash tray assembly available in black primer or wood grain.

IC-321 1968 Black44.95 ea.
 IC-321W 1968 Walnut59.95 ea.
 IAT-143A 1969 Black62.99 ea.
 IAT-144W 1969 Cherrywood74.99 ea.



IC-486

1969 Ash Tray Insert

OE style reproduction insert which fits in the center dash ash tray on your 1969 Camaro.

IC-486 1969 All21.99 ea.



IC-344

1970-81 Dash Ash Tray

Featuring correct grain as original.

IC-344 1970-8139.95 ea.



IK-298



ICG-68



IQ-421



ICG-70



ICG-71



ICG-78



ICG-82

Cigarette Lighter Assemblies

Brand new cigarette lighter assemblies with heating elements.

IK-298 1967 All21.99 ea.
 ICG-68 1968 All23.95 ea.
 IQ-421 1969 All20.99 ea.
 ICG-70 1970 All23.95 ea.
 ICG-71 1971-77 All23.95 ea.
 ICG-78 1978-81 All42.95 ea.
 ICG-82 1982-92 All39.99 ea.



ICH-64K

Cigarette Lighter Housings

Correct 2 piece dash housings for lighter assemblies.

ICH-64K 1967-69 All30.00 ea.
 ICH-72K 1970-78 All26.95 ea.



ITS-601

Fiber Optic Ash Tray Socket

Reproduction fiber optic ash tray lamp socket.

ITS-601 1967-8114.99 ea.

GLOVE BOX



IGD-67F

1967-68 Glove Box Door

OE style reproduction glove box door to replace your dented or rusty original.

IGD-67F 1967-68 Door All99.95 ea.
 IGD-67-HNG 1967-68 Hinge19.99 ea.
 IGB-201 1967-68 Screws2.99 pr.



IGD-905



inside view

1969 Glove Box Door

Excellent reproduction of the original glove box door assembly available in either OE black or Cherrywood.

IGD-659 1969 Black69.99 ea.
 IGD-905 1969 Cherrywood79.99 ea.



IGD-446



IGD-615

1970-81 Glove Box Door

OE style reproduction outer glove box door featuring correct grain and logo.

IGD-446 1970-7778.99 ea.
 IGD-615 1978-8186.99 ea.

Lock assembly sold separately.



IGB-023

Glove Box Door Arm Bumper

This bumper installs on the glove box door arm to prevent the glove box door from rattling. Manufactured from rubber as original.

IGB-023 1970-816.99 ea.

GLOVE BOX *continued*

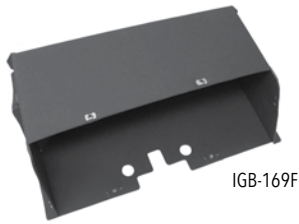

IGB-169F

Glove Box

Correct, die stamped cardboard reproductions.

IGB-167	1967-68 w/o AC	19.99 ea.
IGB-167A	1967-68 w/ AC	19.99 ea.
IGB-169F	1969 w/o AC	19.99 ea.
IGB-169A	1969 w/ AC	19.99 ea.
IGB-170	1970-81 w/o AC	19.99 ea.
IGB-170A	1970-81 w/ AC	19.99 ea.



IK-0827

1968 Glove Box Emblem

OE style reproduction of the Camaro script logo that attaches to the glove box.

IK-0827	1968	22.99 ea.
---------	------------	-----------



IQ-402

Glove Box Screws

Correct glove box screw kit.

IQ-402	1967-69 All	3.95 kit
--------	-------------------	----------



18000

Glove Box Lamp

Socket, bulb and wire

18000	1967-69 All	16.99 kit
-------	-------------------	-----------

Complete with socket, bulb and wire or terminal

36134	1970-79 w/ Wire	19.99 kit
36136	1980-81 w/ Terminals	15.99 kit



ILS-70

Glove Box Lock Striker

Mounts to the dash in the glove box opening to secure the door when it is closed.

ILS-69	1969 All	9.99 ea.
ILS-70	1970-81 All	8.99 ea.



IGB-885

Glove Box Support Bracket

Manufactured to factory specifications from correct steel material, this bracket provides structural support for the glove box and secures it to the dash. One required per vehicle

IGB-885	1970-81 All	18.99 ea.
---------	-------------------	-----------



IQ-891

1967-68 Glove Box Catch Plate

Correct stamped bright zinc catch plate with two screws for easy installation.

IQ-891	1967-68	4.99 ea.
--------	---------------	----------

DASH ACCESSORIES



IK-214

IQ-05

Wiper Knobs

OE style chrome reproduction wiper knobs with correct textures and designs.

IK-214	1967-68 All	8.99 ea.
IQ-05	1969-81 All	4.99 ea.



IC-079

Wiper Switch Nut

Correct chrome nut used to mount the wiper switch.

IC-079	1967-68 All	11.99 ea.
--------	-------------------	-----------



DSE121501

DSE Billet Headlight Knob

A great compliment to the DSE billet wiper knob in the Selecta-Speed wiper kit!

DSE121501	1967-69	19.99 ea.
-----------	---------------	-----------



IK-268



IK-353



IHL-712



IHL-780



IHL-827



IHL-729



IHL-902

Headlight Knobs

Correct knobs with rods.

IK-268	1967-68 All	13.99 ea.
IK-353	1969-70 All	14.99 ea.
IHL-712	1971-78 w/ Logo	16.99 ea.
IHL-780	1979-80 All	28.99 ea.
IHL-827	1982-87 All	23.99 ea.
IHL-729	1988-89 All	24.99 ea.
IHL-902	1990-92 All	25.99 ea.



IC-078

GHR-88

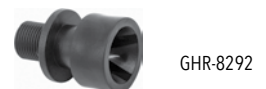

GHR-8292

Headlight Switch Nut

Correct chrome nut used to mount the headlight switch.

IC-078	1967-68 All	11.99 ea.
GHR-88	1969 All	10.99 ea.
GHR-8292	1982-92 All	9.99 ea.

DASH ACCESSORIES *continued*



IB-590

1967 Dash Knob Bezel Set

Correct 4 piece die cast dash knob bezel set. Includes cigarette lighter bezel, headlight switch bezel, ignition switch bezel, wiper switch bezel and complete sticker set.

IB-590 1967 All 19.99 set



B-591

1968 Dash Knob Bezel Set

Correct 4 piece dash knob bezel set. Includes lighter bezel, windshield washer bezel, headlight bezel and ignition bezel. Each bezel features correct lettering.

IB-591 1968 All 16.99 set



IDK-69C

1969 Dash Knob Kit

Complete dash knob set including lighter assembly, headlight knob, radio knobs and windshield washer knobs.

IDK-69C 1969 Mono 29.99 set
IDK-69SC 1969 Stereo 29.99 set



IQ-507

Ignition Bezel Nut

OE style reproduction of this special nut.

IQ-507 1967-68 All 8.99 ea.



IRD-67F

1967-69 Radio Delete Plate

Originally used on specially optioned cars that did not come with a factory radio. Injection molded like original with hot stamped chrome on the edge. This is a show quality piece.

IRD-67F 1967-68 All Black 89.99 ea.
IRD-69F 1969 All Black 74.95 ea.



IRB-678

Radio Face Plate

Correct reproduction of the original radio bezel plate with chrome outer trim and black semi gloss paint.

IRB-678 1967-68 All 29.99 ea.
IRS-533 1967-68 All Screw Set 2.99 kit



IK-213

IK-245

IRK-712

Radio Knobs

Correct inner and outer radio knobs.

IK-520 1967-68 Inner (Mono) 6.99 pr.
IK-520S 1967-68 Inner (Stereo) 8.99 pr.
IK-213 1967-68 Outer 19.99 pr.
IK-231 1969-70 Inner (Mono) 12.99 pr.
IK-231S 1969-70 Inner (Stereo) 12.99 pr.
IK-245 1969-70 Outer 17.99 pr.
IRT-712 1971-78 Inner (Mono) 26.95 pr.
IRT-7S 1971-78 Inner (Stereo) 26.95 pr.
IRK-712 1971-78 Outer w/ Logo 26.95 pr.

STEERING WHEELS



NR-492



IK-712SS

1971-72 SS Steering Wheel

OE style reproduction of this hard to find wheel.

IK-712SS 1971-72 SS Wheel 259.95 ea.
Will fit most years 1969-81.



1969+ 4 Spoke Steering Wheel-Simulated Rope Wrap

IK-7Z 1969+ 4 Spoke Wheel 239.99 ea.

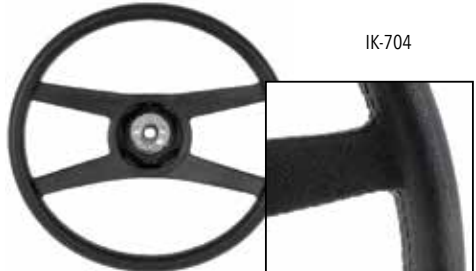

IK-704

1971-77 4 Spoke Sport Steering Wheel

Supurb reproduction of the original GM 4-spoke Sport steering wheel designed for many various 1971-1981 GM models with the NK4 steering wheel option. This quality reproduction features a soft black padding original grain material and a 4-spoke design as original.

IK-704 1971-77 4 Spoke Smooth 259.99 ea.

Standard Wheel Kits

Everything you need to replace your original wheel! High quality reproduction steering wheel, center shroud, horn buttons & contacts.

NR-492 1969 Black 296.96 kit
NR-493 1969 Wood 301.46 kit
NR-70 1970 Black 296.96 ea.

*No Volume Discount

KEEP A LOOK OUT FOR THESE LOGOS BELOW THROUGHOUT THE CATALOG FOR BIG SAVINGS AND DISCOUNTS ON KITS!

BUY 'N SAVE WITH KITS

OER ORIGINAL EQUIPMENT REPRODUCTION

IK-8289



IHC-8289

1982-89 Leather Wrapped Steering Wheel

Reproduction of the original style leather wrapped steering wheel designed for use on 1982-1989 Camaro models. Each steering wheel is produced to factory original specifications with stamped steel center ring and authentic leather grip.

- IK-8289 1982-89 Steering Wheel..... 379.99 ea.
 - IHC-8289 1982-89 Horn Button..... 69.99 ea.
 - IK-730 1982-89 Horn Contact Wire..... 14.99 ea.
- No Volume Discount.



IWN-KIT

Optional SS Cap



Optional Yenko Cap

Wood Steering Wheel Kits

Add one of these beautiful wood grain steering wheels to your car with one of our kits. Each kit includes steering wheel, hub, contacts, horn cap, cam and hardware.

- IWN-KIT 1967-68 Walnut w/o Tilt 342.79 kit
 - IWN-7T 1967-68 Walnut w/ Tilt 342.79 kit
 - IWN-KIT-YENKO 1968 Walnut w/o Tilt Yenko Cap 385.09 kit
 - IWN-7T-YENKO 1968 Walnut w/ Tilt Yenko Cap 385.09 kit
 - IWN-SSKIT 1967-68 Walnut w/o Tilt w/ SS Cap.. 395.89 kit
 - IWN-SS7T 1967-68 Walnut w/ Tilt w/ SS Cap.... 395.89 kit
 - IRW-KIT 1969 Rosewood w/o Tilt..... 347.29 kit
 - IRW-9T 1969 Rosewood w/ Tilt..... 351.79 kit
 - IRW-SSKIT 1969 Rosewood w/o Tilt w/ SS Cap .. 400.39 kit
 - IRW-SS9T 1969 Rosewood w/ Tilt w/ SS Cap 404.89 kit
 - IRW-KIT-YENKO 1969 Rosewood w/o Tilt Yenko Cap ... 389.59 kit
 - IRW-9T-YENKO 1969 Rosewood w/ Tilt Yenko Cap ... 394.09 kit
- Can be used on all 1967-81. No Volume Discount



IXS-69T-H



IXS-SS6970-S



IXS-6970



BUY 'N SAVE WITH KITS

Comfortgrip Steering Wheel Kits

Add some muscle to your interior with our Comfortgrip steering wheel kits.

Each kit includes steering wheel, hub, contacts, horn cap, cam and hardware. These wheels can be used on all models up to 1981.

IXS-678-H	1967-68 Black w/ Silver Spokes w/ Holes	225.96 kit
IXS-6970-H	1969-70 Black w/ Silver Spokes w/ Holes w/o Tilt	230.21 kit
IXS-69T-H	1969-70 Black w/ Silver Spokes w/ Holes w/ Tilt	234.46 kit
IXS-678-S	1967-68 Black w/ Silver Spokes w/ Slots	225.96 kit
IXS-6970-S	1969-70 Black w/ Silver Spokes w/ Slots w/o Tilt	230.21 kit
IXS-69T-S	1969-70 Black w/ Silver Spokes w/ Slots w/ Tilt	234.46 kit
IXS-678	1967-68 Black w/ Silver Spokes	225.96 kit
IXS-678-BLK	1967-68 Black w/ Black Spokes	225.96 kit
IXS-6970-BLK	1969-70 Black w/ Black Spokes w/o Tilt	230.21 kit
IXS-69T-BLK	1969-70 Black w/ Black Spokes w/ Tilt	234.46 kit
IXS-6970	1969-72 Black w/o Tilt	230.21 kit
IXS-69T	1969-72 Black w/ Tilt	234.46 kit
IXS-SS678-H	1967-68 Black w/ Silver Spokes w/ Holes SS cap	276.11 kit
IXS-SS6970-H	1969-70 Black w/ Silver Spokes w/ Holes w/o Tilt w/ SS Cap	297.36 kit
IXS-SS69T-H	1969-70 Black w/ Silver Spokes w/ Holes w/ Tilt w/ SS Cap	284.61 kit
IXS-SS678-S	1967-68 Black w/ Silver Spokes w/ Slots SS Cap	276.11 kit
IXS-SS6970-S	1969-70 Black w/ Silver Spokes w/ Slots w/o Tilt w/ SS Cap	297.36 kit
IXS-SS69T-S	1969-70 Black w/ Silver Spokes w/ Slots w/ Tilt w/ SS Cap	284.61 kit
IXS-SS678-BLK	1967-68 Black w/ Silver Spokes w/ SS Cap	276.11 kit
IXS-SS6970-BLK	1969-70 Black w/ Black Spokes w/o Tilt w/ SS Cap	280.36 kit
IXS-SS69T-BLK	1969-70 Black w/ Black Spokes w/ Tilt w/ SS Cap	284.61 kit
IXS-SS6970	1969-70 Black w/o Tilt w/ SS Cap	280.36 kit
IXS-SS69T	1969-70 Black w/ Tilt w/ SS Cap	284.61 kit
IXS-69T-YENKO	1969-70 Black w/ Tilt Yenko Cap	274.41 kit
IXS-6970-YENKO	1969-70 Black w/o Tilt Yenko Cap	270.16 kit
IXS-6970-BLUE	1969-70 Bright Blue w/o Tilt	247.21 kit
IXS-69T-BLUE	1969-70 Bright Blue w/ Tilt	251.46 kit
IXS-6970-RED	1969-70 Red w/o Tilt	247.21 kit
IXS-69T-RED	1969-70 Red w/ Tilt	251.46 kit
IXS-SS6970-BLUE	1969-70 B. Blue w/o Tilt w/ SS Cap	297.36 kit
IXS-SS69T-BLUE	1969-70 B. Blue w/ Tilt w/ SS Cap	301.61 kit
IXS-SS6970-RED	1969-70 Red w/o Tilt w/ SS Cap	297.36 kit
IXS-SS69T-RED	1969-70 Red w/ Tilt w/ SS Cap	301.61 kit

Correct for 1969-70 but can be used on all 1967-81.

No Volume Discount



IK-977



IJ-44

Standard Steering Wheels

GM licensed reproduction standard wheels.

IK-977	1967-68.....	219.99 ea.
IJ-44	1969.....	224.99 ea.

Can be used on all 1967-81. No Volume Discount



IK-436



IK-536

Deluxe Steering Wheels

OE style reproduction deluxe steering wheel featuring correct "spider style" chrome insert. Can be used on all 1967-81.

IK-436	1967 Chrome.....	290.99 ea.
IK-536	1968 Brushed.....	289.99 ea.



IK-622



IK-623



IM-377



IM-370



IM-370-BLKS



IM-379

Sport Steering Wheels

OE style reproduction sport steering wheels to replace your originals or upgrade from standard.

IK-622	1967-68 Walnut.....	274.99 ea.
IK-623	1969 Rosewood.....	274.99 ea.
IM-370	1969-70 Black.....	159.95 ea.
IM-370-BLUE	1969-70 Bright Blue.....	179.95 ea.
IM-370-RED	1969-70 Red.....	179.95 ea.
IM-370-BLKSPK	1969-70 Black w/ Black Spokes.....	159.95 ea.
IM-377	1969-70 Black w/ Silver Spokes w/ Holes.....	159.95 ea.
IM-379	1969-70 Black w/ Silver Spokes w/ Slots.....	159.95 ea.

Can be used on all 1967-81.



GT36-5459-1K



GT14-4331-2K

BUY'N SAVE WITH KITS

GT Performance Steering Wheel Kits

Our exclusive GT Performance steering wheel kits take away all guess work! Upgrade your worn out original steering wheel with these exclusive GT Performance steering wheel kits! They include everything you'll need to make the swap, steering wheel, hub and horn button.

GT14-4331-1K	1967-68 GT3 Classic Foam Wheel.....	173.99 kit
GT14-4331-2K	1969-81 GT3 Classic Foam Wheel.....	173.99 kit
GT14-5437-1K	1967-68 GT3 Classic Wood Wheel.....	271.99 kit
GT14-5437-2K	1969-81 GT3 Classic Wood Wheel.....	271.99 kit
GT36-5431-1K	1967-68 GT3 Retro Foam Wheel Chrome.....	179.99 kit
GT36-5431-2K	1969-81 GT3 Retro Foam Wheel Chrome.....	179.99 kit
GT36-5451-1K	1967-68 GT3 Retro Foam Wheel Stainless.....	179.99 kit
GT36-5451-2K	1969-81 GT3 Retro Foam Wheel Stainless.....	268.99 kit
GT36-5457-1K	1967-68 GT3 Retro Light Wood Wheel.....	347.99 kit
GT36-5457-2K	1969-81 GT3 Retro Light Wood Wheel.....	347.99 kit
GT36-5459-1K	1967-68 GT3 Retro Dark Wood Wheel.....	347.99 kit
GT36-5459-2K	1969-81 GT3 Retro Dark Wood Wheel.....	347.99 kit

STEERING ACCESSORIES



IK-062

Steering Wheel Hubs

Correct cast steering wheel mounting hub for all cars with sport wheels.

IK-062	1967-68 All	42.95 ea.
IJ-3520	1969 All	42.95 ea.



IC-583



IW-178E



IW-178B



IC-354



IW-178C



IW-178E



IW-179B



ICC-477

1967-68 Horn Cap Assemblies

Correct reproduction horn caps for standard and deluxe wheels. Expertly crafted die cast piece with polished horn caps.

IC-583	1967 Std Chrome.....	36.99 ea.
IW-178E	1967 RS Chrome.....	25.99 ea.
IW-178B	1967 SS Chrome.....	26.99 ea.
IC-354	1968 Std Brushed.....	39.99 ea.
IW-178C	1968 SS350 Chrome.....	25.99 ea.
IW-179E	1968 RS Brushed.....	23.99 ea.
IW-179B	1968 SS Brushed.....	23.99 ea.
ICC-477	1967-68 Rubber Retainer Ring.....	4.99 ea.



IC-3380

1967-70 Sport Horn Cap

Excellent reproduction of the original horn cap used on sport wheels and woodgrain wheels.

IC-3380	1967-70 All Sport.....	32.95 ea.
---------	------------------------	-----------



IHC-71

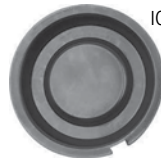

ICR-71



ICE-742



ICE-737



ICE-649



ICE-315

1971-81 NK4 Horn Caps

OE style reproduction caps and accessories for your optional NK4 sport wheel.

IHC-71	1971-81 Horn Cap.....	18.99 ea.
ICR-71	1971-81 Cap Retainer.....	9.99 ea.
ICE-742	1971-81 Bowtie Emblem.....	29.99 ea.
ICE-737	1971-81 Circle Emblem.....	26.99 ea.
ICE-649	1971-79 Camaro Emblem.....	23.99 ea.
ICE-315	1973-78 Style LT Emblem.....	26.99 ea.
ICE-886	All* SS Emblem.....	26.99 ea.

*Not stock for Camaro, but will fit and function as original.



IWE-6775

IWE-4475

1968 N30 Emblems

OE style reproduction emblems for the 1968 optional N30 deluxe steering wheel.

IWE-6775	1968 SS.....	23.00 ea.
IWE-4475	1968 SS396.....	29.95 ea.



IHC-SS

SS Horn Button

Awesome brushed aluminum cap with SS logo for all sport wheels.

IHC-SS	1967-69 w/ Sport.....	91.95 ea.
--------	-----------------------	-----------



IHC-YENKO

Yenko Horn Button

Custom brushed aluminum cap with Yenko Logo. For all sport wheels.

IHC-YENKO	1967-70 w/ Sport.....	79.95 ea.
-----------	-----------------------	-----------



IFK-3

Hazard Lamp Knob

Brand new chrome flasher knob.

IFK-3	1967-70 All	11.95 ea.
-------	-------------------	-----------



NK-126



NK-213



NK-292



IC-588



IC-587

Standard Shroud

Excellent high quality reproduction.

NK-126	1969 Shroud Black	64.99 ea.
NJ-127	1969 Shroud Wood.....	69.99 ea.
NK-213	1969 Horn Buttons.....	19.99 pr.
NK-292	1969 Horn Contacts.....	19.99 pr.
IC-588	1969 SS Emblem.....	14.99 ea.
IC-587	1969 RS Emblem.....	11.99 ea.
IC-589	1969 Bowtie.....	11.95 ea.



IK-8

Horn Contact Kits

Complete kit for repairing horn contacts.

IHC-KIT	1967- 68 All Standard.....	29.99 ea.
IHC-KITX	1967- 68 All Deluxe.....	29.95 kit
IHC-7	1967- 68 Sport All.....	29.99 ea.
IK-579	1969 & Up Sport w/o Tilt.....	34.99 ea.
IK-8	1969 & Up Sport w/ Tilt.....	39.99 ea.
ICS-3	1967-69 Sport Spring/Pin.....	6.99 ea.
IHC-KIT	1970-81 w/ 4 Spoke Wheel.....	29.99 ea.



ICC-7

Turn Signal Cancel Cam

Correct cam which turns off signal light.

ICC-7	1967-68 All	16.95 ea.
ICC-9	1969 w/o Tilt	16.99 ea.
ICC-93	1969 w/ Tilt	16.99 ea.

ORIGINAL GM



TILT-69FA

Original Steering Columns

These steering columns are the real deal! Each original GM unit is professionally rebuilt using OEM parts. We even include the turn signal switch! Limited supply!

TILT-67F	1967-68 Tilt.....	668.99 ea.
TILT-69FA	1969 Tilt.....	599.99 ea.
TILT-69FAOC	1969 Automatic on Column.....	599.99 ea.
INT-69FA	1969 Non-Tilt All.....	538.99 ea.

TILT-70F	1970-76 w/ Console.....	599.99 ea.
INT-70F	1970-76 Non-Tilt Floor Shift Automatic.....	668.99 ea.
TILT-77F	1977-78 w/ Console.....	599.99 ea.
TILT-79F	1979-81 Floor Shift.....	605.99 ea.

No Volume Discount. Ships Oversize.

Flaming River Tilt Steering Columns & Kits

Flaming River offers replacement tilt steering columns for your ride. They require no welded on attachments or extra relays. Modeled after the popular muscle car Tilt Key Columns, but still attractive enough to put in your street rod. Flaming River manufactures the column complete with a GM coded key assembly, wiring and ignition switch made from state-of-the-art, all new components. Made in the USA.

FR30009BK



FR-F678MK-P



Tilt Steering Columns

FR21019	1967-1968, 1" 48 Spline Shaft, Paintable.....	788.99 ea.
FR21019BK	1967-1968, 1" 48 Spline Shaft, Black.....	961.99 ea.
FR21019PL	1967-1968, 1" 48 Spline Shaft, Polished.....	961.99 ea.
FR21020	1967-1968, 1" DD Shaft, Paintable.....	610.99 ea.
FR21020BK	1967-1968, 1" DD Shaft, Black.....	753.99 ea.
FR21020PL	1967-1968, 1" DD Shaft, Polished.....	790.99 ea.
FR30009	1969-1978, 1" 48 Spline Shaft, Paintable.....	897.99 ea.
FR30009BK	1969-1978, 1" 48 Spline Shaft, Black.....	991.99 ea.
FR30009SS	1969-1978, 1" 48 Spline Shaft, Polished.....	1187.99 ea.
FR30010	1978-1981, 1" 48 Spline Shaft, Paintable.....	897.99 ea.
FR30010BK	1978-1981, 1" DD 48 Spline Shaft, Black.....	1043.99 ea.
FR30010SS	1978-1981, 1" DD 48 Spline Shaft, Polished.....	1187.99 ea.

Manual Steering Kit

FR-F678MK-P	1967-68 Paintable.....	1049.37 kit
FR-F678MK-BK	1967-68 Black.....	1190.67 kit
FR-F678MK-PL	1967-68 Polished.....	1190.67 kit

Power Steering Kit

FR-F678PK-P	1967-68 Paintable.....	1049.37 kit
FR-F678PK-BK	1967-68 Black.....	1190.67 kit
FR-F678PK-PL	1967-68 Polished.....	1190.67 kit

Power or Manual Steering Kit

FR-F69K-P	1969 Paintable.....	971.97 kit
FR-F69K-BK	1969 Black.....	1048.47 kit
FR-F69K-PL	1969 Polished.....	1209.57 kit

*No Volume Discount

Flaming River Steering Column Installation Accessories

FRCA103	1967-68 Install Kit Manual Steering.....	345.99 kit
FRCA104	1967-68 Install Kit Power Steering.....	345.99 kit
FRCA105	1969 Install Kit Manual Steering w/o Key In Column.....	414.99 kit
FRCA106	1969 Install Kit Power Steering w/o Key In Column.....	414.99 kit
FRCA107	1970-81 Install Kit Power Steering w/o Key In Column.....	292.99 kit
FRCA110	1969-81 Key Column Install Kit.....	141.99 kit
FR20300	1969-72 Stramp Clamp.....	68.99 ea.
FR20101FB	1967-69 Floor Mount.....	148.99 ea.
FR20101CA	1970-81 Floor Mount.....	137.99 ea.
FR20118-2	All Wiring Adapter.....	107.99 kit



ICC-12005



RSC-1072F

Steering Column Cap

Correct cap used to hold the end of column together.

ICC-12005	1969-77.....	20.95 ea.
-----------	--------------	-----------

Steering Column Clamp Plate

Correct clamps used to hold steering column to firewall.

RSC-1072F	1969.....	39.95 ea.
-----------	-----------	-----------



GIS-1001B

Steering Column Support

Correct bracket which holds the steering column to the bottom of the dash.

GIS-1001B	1967-68.....	64.95 ea.
GIS-1001E	1969.....	64.95 ea.



3949736

Steering Column Covers

Correct injection molded lower covers.

3914799	1967-68 All.....	32.95 ea.
3949736	1969 All.....	24.99 ea.



RCS-1

Steering Column Shim

Steering column shim (wedge). 2 usually required.

RCS-1	1967 All.....	16.99 ea.
-------	---------------	-----------



FBK-678

1967-1977 Steering Column Lower Bearing Upgrade Kits

You would want to replace this bearing if you are changing the lower steering shaft or replacing the steering coupler that attaches to the gear box, as the lower steering shaft has to be removed to slip the old bearing assembly out and install the new one. You do not need to remove the main steering shaft that this bearing kit goes onto.

- FBK-678 1967-68 All w/o Tilt..... 69.95 ea.
 - FBK-752 1969-77 All w/ Tilt..... 49.99 kit
- No Volume Discount.



FBK-TILT

1969-75 Tilt Column Upper Bearing

This is a brand new upper steering column bearing for tilt columns only. This part commonly fails and is an easy way to make a worn out column like new again.

- FBK-TILT 1969-75..... 74.99 ea.

Tilt Steering Column Housing Sleeve Floor Shift

Reproduction Camaro tilt steering column housing sleeve. This can be used to replace a column shift sleeve to convert your column to floor shift manual or automatic.



- ISC-6981 1969-81 w/ Tilt Floor Shift..... 84.99 ea.
- No volume discount.



ICG-5008

1969-77 Tilt Ignition Switch Actuator Gear

This is a brand new steering ignition switch actuator gear for tilt columns only. This part commonly fails and is an easy way to make a worn out column like new again.

- ICG-5008 1969-77 22.99 ea.



Tilt Wheel Levers IT-4470

OE style reproduction tilt wheel release levers.

- IT-4470 1967 19.95 ea.
- IT-5168 1968-70 14.95 ea.
- IT-2951 1971-78 14.95 ea.



Turn Signal Levers IT-3208

OE style reproduction turn signal levers.

- IT-3208 1967 w/o Tilt 23.95 ea.
- IT-5165 1967 w/ Tilt 21.95 ea.
- IT-5174 1968-70 All 16.95 ea.
- IT-5176 1971-81 All 16.95 ea.
- IT-2303G 1982-83 With Wiper & Cruise 32.99 ea.

HEATING ACCESSORIES



1967-68 Heater Control Assembly IHC-67

Complete heater control unit pre-assembled and ready to install with faceplate featuring correct lettering.

- IHC-67 1967 w/o AC.....264.99 ea.
- IHC-67A 1967 w/ AC.....299.99 ea.
- IHC-68 1968 w/o AC.....264.99 ea.
- IHC-68A 1968 w/ AC.....299.99 ea.



IHC-69

1969 Heater Control Assembly

Complete heater control unit pre-assembled and ready to install. Includes faceplate with correct lettering and cables.

- IHC-69 1969 w/o AC.....297.99 ea.



IC-425

1977-81 Heater Control Backing Plate

Injection molded heater control backing plate, with included built-in lens retaining clips. Replaces the commonly broken heater control switch mount (for AC or non-AC) easily and reliably.

- IC-425 1977-81 All 32.99 ea.



IC-455

Heater Control Lenses

Correct letters and backgrounds.

- IC-453 1967 w/o AC 14.99 ea.
- IC-453A 1967 w/ AC 13.99 ea.
- IC-455 1968 w/o AC 14.99 ea.
- IC-455A 1968 w/ AC 13.99 ea.
- IC-497 1969 w/o AC 16.99 ea.
- IC-497A 1969 w/ AC 16.99 ea.
- ICR-495 1969 w/o AC White Backing 18.99 ea.
- ICR-496 1969 w/ AC White Backing 18.99 ea.
- IC-410 1969-76 Heater Lens Clips 3pc.....7.99 kit



IC-410



IJ-660

1967-81 Heater Control Knobs

Chrome heater control knobs.

- IJ-660 1967-81 All 3.95 ea.
- IJ-426 1967-81 All 4pc 11.99 kit



I-896

1967-68 Heater Lever

Correct reinforced reproduction of this commonly missing defroster and de-ice lever.

- I-896 1967-68 All 11.99 ea.



IHC-453CC

Heater Control Cables

Set of three correct heater control cables with inner poly line for smooth operation.

- IHC-453CC 1967-68 w/o AC 39.99 set
- IHC-497CC 1969 w/o AC..... 39.99 set
- IHC-497ACC 1969 w/ AC..... 39.99 set



BCR-12658

1967-69 Heater Cable Retainer Set

Correct inner cable retaining clips.

- BCR-12658 1967-69 6pc 3.95 kit



I-69FX

1969 Heater Lever Repair Kit

Includes 3 levers, 3 sleeves and 3 knobs to repair your original heater control.

- I-69FX 1969 All 51.95 kit

IDB-660



IDS-093

1970-78 Defogger

Excellent reproduction defogger switch and bezel which mounts on the right side of the instrument panel as original.

- IDS-093 1970-78 Switch..... 49.99 ea.
- IDB-660 1970-78 Bezel 24.99 ea.



AIR CONDITIONING ACCESSORIES



IK-48L

Kick Panels

OE style reproduction kick panel assemblies.

IK-48L	1967-68 w/o AC LH.....	92.99 ea.
IK-48R	1967-68 w/o AC RH.....	92.99 ea.
IK-8ACL	1967-68 w/ AC LH.....	94.99 ea.
IK-8ACR	1967-68 w/ AC RH.....	94.99 ea.
IK-69L	1969 w/o AC LH.....	59.99 ea.
IK-69R	1969 w/o AC RH.....	59.99 ea.
IK-9ACL	1969 w/ AC LH.....	95.99 ea.
IK-9ACR	1969 w/ AC RH.....	95.99 ea.
IK-7L	1970-81 w/o AC LH.....	95.99 ea.
IK-7R	1970-81 w/o AC RH.....	95.99 ea.
IK-7ACL	1970-81 w/ AC LH.....	99.99 ea.
IK-7ACR	1970-81 w/ AC RH.....	99.99 ea.
IKJ-9	1967-69 Insulation.....	8.99 pr.



IRE-1281

Firewall Insulation Pad

Correct die-stamped original material complete with plugs. Rubber plugs also sold separately.

IRE-1281	1967-69 w/o AC.....	48.99 ea.
IRE-1281A	1967-69 w/ AC.....	48.99 ea.
IRE-1283	1970-81 w/o AC.....	48.99 ea.
IRE-1283A	1970-81 w/ AC.....	48.99 ea.
IRE-PLUG	1967-72 Plug.....	3.99 ea.

PEDALS & ACCESSORIES



ICE-4740

IYC-2525

ICE-0296

ICE-3611

Accelerator Pad & Trim

OE style reproduction pads with correct ribbing and stainless trim to finish them off.

ICE-4740	1970-71 Z/28 Pad.....	16.99 ea.
ICE-0296	1967-81 Pad.....	6.95 ea.
IYC-2525	1970-71 Z/28 Trim.....	14.95 ea.
ICE-3611	1967-81 Trim.....	5.99 ea.



APA-68

Accelerator Pedal Linkage Kit

New assemblies complete from the pedal to the arm and includes the pedal trim.

APA-68	1967-69 V8 w/o Cowl Induction	57.95 kit
APA-69CI	1967-69 w/ Cowl Induction	59.99 kit



IST-3

AZC-88

ICE-8078

Accelerator Hardware

Correct hardware for pad and cable.

IST-3	1970-71 Z/28 Stud.....	3.95 ea.
ICE-8078	1967-81 Spring/Pin.....	9.95 ea.
AZC-88	Cable Clip	6.95 ea.
AY-12	1968-69 Pedal Rod Support Plastic.....	16.99 ea.



APA-6CBH



Throttle Linkage To Cable Conversion Kit

Remove the old sticky linkage and upgrade to a smooth operating throttle cable set up. This kit includes the accelerator pedal assembly, accelerator cable, cable bracket and cable retaining clip.

APA-6CBH	1967-69 Holley.....	105.64 kit
APA-6CBQJ	1967-69 Q-Jet.....	108.04 kit

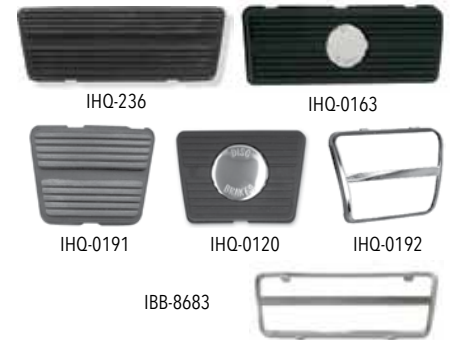

IHQ-236

IHQ-0163

IHQ-0191

IHQ-0120

IHQ-0192

IBB-8683

Brake/Clutch Pads & Trim

OE style reproduction pads with correct ribs and medallions where applicable.

IHQ-236	All Auto Drum 6.5".....	4.99 ea.
IHQ-0163	All Auto Disc 6.5".....	9.99 ea.
IBB-8683	Auto Brake Trim.....	5.99 ea.
IHQ-0191	4 Speed Drum Brake.....	4.95 ea.
IHQ-0120	4 Speed Disc Brake	11.99 ea.
IHQ-0192	4 Speed Trim	5.99 ea.
IHQ-99F	1972-81 Small Clutch.....	9.95 ea.
IHQ-0125	1972-81 4 Speed w/ Disc Brake	9.95 ea.

Clutch Pads & Trim

IHQ-0191	1967-71 Pad	4.95 ea.
IHQ-99F	1972-81 Pad	9.95 ea.
IHQ-0192	1967-72 Trim	5.99 ea.



IHQ-0229

IHQ-0108

E-Brake Pedal

OE style reproduction emergency brake pedal and stainless trim.

IHQ-0229	1967-68 Pad	3.95 ea.
IHQ-0203	1969-81 Pad	3.99 ea.
IHQ-0108	1967-68 Trim	4.99 ea.
IHQ-0122	1969-81 Trim	4.99 ea.



TA-206-BKM1

Billet Throttle Assembly

This billet throttle assembly by Clayton Machine Works is a killer interior upgrade for your muscle car! This set includes a complete billet throttle assembly with a custom pedal pad featuring unique rubber inserts. Also included are matching pedal covers for your brake pedal (automatic) or brake and clutch pedals (manual). These pads require no drilling and simply clamp over your existing pedals.

Black Anodized

TA-206-BKM1	1967-69 Manual.....	370.99 kit
TA-206-BKM2	1970-81 Manual.....	370.99 kit
TA-206-BKA1	1967-69 Auto.....	317.99 kit
TA-206-BKA2	1970-81 Auto.....	317.99 kit



Hurst Shifter

New Hurst Competition Plus shifter complete with Hurst handle and shifter ball.

3914339	1967-68 Muncie	411.99 ea.
3917438	1969 Muncie	413.99 ea.
3916848	1970-72 Muncie	405.99 ea.
3917438	1973-77 Muncie	413.99 ea.
HURST-3917960	1982 Console/Borg Warner	405.99 ea.

No Volume Discount



Hurst Installation Kits

Complete kit with rods, levers, swivels and hardware.

3734529	1967-68 Muncie	218.99 kit
3737437	1969 Muncie	231.99 kit
3737897	1970-72 Muncie	243.99 kit
3738605	1973-74 Muncie	243.99 kit
3738609	1974-81 BWT10	236.99 kit

No Volume Discount



Shifter Balls

OE style reproduction shifter balls.

FZ-1420	Muncie White 5/16"	21.99 ea.
FZ-1424	Hurst White 3/8"	24.99 ea.
FW-115	Chrome 5/16"	24.99 ea.
FW-117	Chrome 3/8"	23.99 ea.
FW-157	Black/Chrome 5/16"	21.99 ea.
FW-159	Black/Chrome 3/8"	21.99 ea.
FW-38HURST	Hurst White 3/8" 4 Speed	38.99 ea.



HURST-5380436



Hurst Automatic Shifter Handle

Hurst introduces their new Billet/ Plus Pistol-Grip Shift Handle for the 2016-2018 Camaro with the automatic transmission. This is a great way to add a contemporary performance look to your modern day muscle car. Billet Aluminum construction is precision CNC machined for a modern look and feel. The body features a polished finish, while the replaceable grip plates have a black anodized finish and display the iconic Hurst name. The grip features a comfortable shape that just feels "right" in your hand, along with a finger operated trigger mechanism for the lockout function.

HURST-5380436	2016-18 Auto	226.99 ea.
---------------	--------------------	------------

No volume discount.



FACTORY STYLE

1969 OE Hurst Shifter

OE style reproduction of the highly sought after shifter used on all 1969 Camaro 4 speeds. Features correct style handle exclusive to 1969 Camaros.

HURST-69	1969 All	399.95 ea.
----------	----------------	------------



1969 OE Hurst Shifter Installation Kits

Correct installation hardware kits for your 1969 Hurst Shifter.

HURST-69SB	1969 SB	136.95 ea.
HURST-69BB	1969 BB	249.95 ea.



Hurst T Handle Shifter Knob

This brushed aluminum T-handle provides a positive feel for accurate gear selection. A favorite in the performance world for years! Includes adapters for most popular shift handles.

FW-HURST	T-Handle	36.99 ea.
HURST-1530010	T-Handle Brushed Alum w/ Button ..	72.99 ea.
HURST-1530011	T-Handle Polished Alum w/ Button ..	72.99 ea.



Hurst Replacement Shifter Handles

These handles all feature a universal installation kit with SAE 1/2-20, 7/16-20, 3/8-16 and also Metric M10x1.25, M10x1.50, M12x1.25, M12x1.75 and M16x1.50 thread size.

HURST-1531000	Pistol Grip Silver	58.99 ea.
1531003	Pistol Grip Black	107.99 ea.
HURST-1536200	Pistol Grip Silver w/ 12v Switch	75.99 ea.
HURST-1536210	Pistol Grip Black w/ 12v Switch	75.99 ea.
HURST-1539000	Pistol Grip Silver	58.99 ea.
HURST-1630050	Round Black* w/ 12v Switch	79.99 ea.

**7/16 - 20 threads only. No volume discount.*



Reverse Lockout Kit

Complete with 2 rods and swivel mechanism.

NA-578	1969 All	84.95 kit
NA-704	1970-74	134.95 kit



1967 Universal Shifter Kit

Universal Camaro shifter that has the look of the factory shifter setup for both the 3 speed TH350/TH400 overdrive 700-R4, 200-4R, 4L60, 4L65 and the 4L80. Complete with neutral safety/ back up switch, all rod linkage components and factory-like reverse lock out and detents for each gear. Also includes a universal floor mounting bracket kit.

SW280-RCT	1967 All	349.95 kit
-----------	----------------	------------



B&M Universal Shift Handle w/ Button

This B&M Universal Button T-handle fits most B&M and aftermarket shifters. Includes: Thread inserts to fit 1/2-20, 3/8-24, 3/8-16 & 5/16-18 SAE. A 12v momentary switch to activate Line-Lock, transbrake or nitrous.

BM-80658	Aluminum Polished	55.99 ea.
BM-80659	Aluminum Chrome	62.99 ea.

No volume discount.



B&M Automatic Shifter Knobs

Adapters included with these knobs fit 1/2-20, 3/8-24, 3/8-16 and 5/16-18 SAE threads.

BM-80534	Quicksilver Billet Aluminum Silver	65.99 ea.
BM-46112	Round White w/ 12v Switch*	78.99 ea.

**Works with 12 volt and 16 volt systems and may be used to activate transbrake, launch control, nitrous or two step. No volume discount.*



THIS IS AN EXCLUSIVE GROUND UP PRODUCT

FMCK-67S

Manual Transmission Conversion Kit

Planning on swapping from automatic to a 4 speed manual? This kit will take the headache out of the switch by providing you with all of the parts needed to make your conversion simple! This complete kit includes the brake/clutch pedals, Z bar, rods, boots, cross shaft kit, springs, bracket and all hardware!

FMCK-67S	1967-68 SB	174.94 kit
FMCK-67B	1967-68 BB	185.14 kit
FMCK-69S	1969 SB	191.85 kit
FMCK-69B	1969 BB	201.45 kit
FMCK-70S	1970-71 V8	215.02 kit
FMCK-70B	1972-81 V8	215.02 kit

with Headers*

FMCK-67S-HD	1967-68 SB	169.81 kit
FMCK-67B-HD	1967-68 BB	173.26 kit
FMCK-69S-HD	1969 SB	187.02 kit
FMCK-69B-HD	1969 BB	195.82 kit

No Volume Discount

*Includes everything that comes in regular kits except the small spring and extension rod which can not be used with headers.



FCI-99A

IBP-628

Brake Pedal Assembly

OE style reproduction brake pedal assembly for automatic transmission. 6.5" wide.

FCI-99A	1967-72 Auto Pedal 6.5"	36.99 ea.
IBP-628	1967-69 Pedal Pivot Pin	14.99 ea.



FPB-97

FPB-103

Clutch Pedal Bushing & Bumper

Correct nylon bushing used for ease of pedal.

FPB-97	All Bushing	1.99 ea.
FPB-103	All Bumper	3.95 ea.



FCI-1860

Clutch & Brake Pedal Assemblies

Complete reproduction brake/clutch pedals.

FCI-1860	1967-68	65.99 ea.
FCI-1869	1969	99.99 ea.
FCI-1870	1970-71	89.99 ea.
FCI-1872	1972-81	89.99 ea.



IPA-EB

IPA-67FM



Muscle Car Pedal Assembly

This awesome Camaro pedal assembly by Clayton Machine Works is machined from forged aluminum and comes complete with pedal arms, pedals with dimpled rubber pads and all necessary hardware for installation. This means that you'll have that one-off custom look without the one-off price all in a complete easy to install bolt in package.

DBW = Drive by Wire

IPA-67FA	1967 Auto	556.99 kit
IPA-67FAD	1967 Auto DBW	509.99 kit
IPA-67FM	1967 Manual	737.99 kit
IPA-67FMD	1967 Manual DBW	689.99 kit
IPA-68FA	1968 Auto	556.99 kit
IPA-68FAD	1968 Auto DBW	509.99 kit
IPA-68FM	1968 Manual	737.99 kit
IPA-68FMD	1968 Manual DBW	689.99 kit
IPA-69FA	1969 Auto	556.99 kit
IPA-69FAD	1969 Auto DBW	509.99 kit
IPA-69FM	1969 Manual	737.99 kit
IPA-69FMD	1969 Manual DBW	689.99 kit

No Volume Discount

Muscle Car E-Brake Cover

This e-brake cover is meant to match your Clayton Machine Works pedal assemblies perfectly. It also can be used alone to dress up your interior. Complete with mounting hardware.

IPA-EB	1967-81 All	53.99 ea.
--------	-------------	-----------

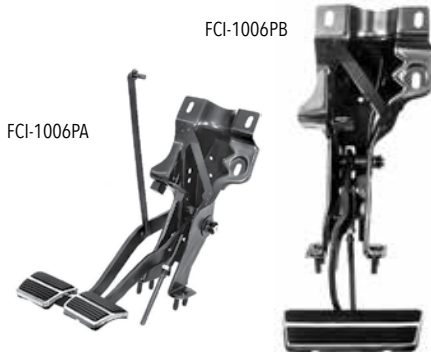

FCI-1006PB

FCI-1006PA

Pedal Assemblies Complete

These complete assemblies come with the support hanger bracket, pedals, pads, pins and bushings. Available in manual and automatic.

FCI-1006PA	1967-68 Manual	299.95 ea.
FCI-1006PB	1967-68 Auto	249.95 ea.



IBH-8292

1982-92 Parking Brake Handle

Excellent reproduction parking brake handle wrapped in leather.

IBH-8292	1982-92 All w/ Leather	79.99 ea.
----------	------------------------	-----------



IPA-EB

E Brake Assemblies

OE style reproduction parking brake assemblies complete with correct pad and trim.

IBA-67	1967-68 All	64.95 ea.
IBA-69	1969 All	64.95 ea.



GBL-852



GBL-852-CC

Brake Light Switches

OE style brake light switches located above the brake pedal.

GBL-852	1967-81 All w/o Cruise Control	7.95 ea.
GBL-852-CC	1967-79 All w/ Cruise Control	19.95 ea.



IEB-110

E-Brake Knobs

OE style reproduction emergency brake pedal knob with the correct white lettering.

IEB-110	1967-81 Knob Only	5.95 ea.
---------	-------------------	----------



MSEX-108

MSEX-103

Compact Fire Extinguisher

These fire extinguishers are designed to be compact enough to fit in your muscle car without sacrificing space. Be prepared and protect your investment.

MSEX-108	Small 1 LB	140.99 ea.
MSEX-103	Large 2.5 LB	172.99 ea.

CARPETS & MATS

Carpeted Floormats

This is a set of four Camaro custom carpeted floor mats featuring correct 80/20 looped carpet and modern style nibbed backing. These universal floor mats fit all years of Camaro and the nibbed backing ensures that these mats will not slide around under your feet. These 80/20 looped carpet mats are a perfect match for your new ACC carpet and are an awesome finishing touch for your interior! Each front mat measures 25.75 H x 16.75 W. Each rear mat measures 13.50 H x 15.875 W.



USE YOUR PHONES CAMERA OR ANY QR APP & SCAN NOW TO SHOP FOR THE MATS YOU NEED!



BUY'N SAVE WITH KITS

ICE-6732K



Carpet Sill Plates

Authentic "Body by Fisher" sill plates available as beautiful reproductions.

7644760	1967-69 Exact Repro w/ Rivets LH or RH.....	22.99 ea.
7644760K	1967-69 Pair w/ Rivets	42.44 kit
ICE-6732L	1970-81 LH w/ Riveted Tag	36.99 ea.
ICE-6732R	1970-81 RH w/ Riveted Tag.....	36.99 ea.
ICE-6732K	1970-81 Pair w/ Rivets	62.34 kit
ISP-KIT	Screw Kit 8pc.....	3.95 kit

Note: 1970-81 are interchangeable. Riveted tag correct for 1970-72. Stick on tag correct for 1973-81.



HURST-6371003



HURST-6370000

Hurst Logo Floor Mats

Show off your Hurst pride with a set of these high quality embroidered Hurst logo floor mats. The embroidered Hurst logo on the front set of mats features the Iconic accented Hurst logo. The Elite Series floor mats are also available with the Iconic Gold/Black Hurst logo reminiscent of Hurst Performance cars from back in the day. Now you have choices when wanting to accent or match your vehicles interior with your exterior. These mats are cut to an exact OEM cut fit with OEM-style attachment points (when applicable) and non-slip backing.

HURST-6370000	2010-15 Front/Rear Red Logo	145.99 kit
HURST-6371000	2010-15 Front/Rear Gold Logo	145.99 kit
HURST-6370003	2016-18 Front Only Red Logo	139.99 kit
HURST-6371003	2016-18 Front Only Gold Logo	139.99 kit

No volume discount.



IK-252



Firewall Insulators

A Firewall Insulator panel by QuietRide Solutions is your first line of defense to stop engine noise and heat from entering the passenger cabin. This firewall panel is an OEM replacement and is year, make and model specific. It is molded to fit the engine setback and firewall contours and fits like a glove.

GMF-6769-HC	1967-68 Heater Only	173.99 kit
GMF-6869-HC	1968-69 Heater Only	173.99 kit
GMF-6869-AC	1968-69 Factory A/C	173.99 kit
GMF-7081-HC	1970-81 Heater Only	177.99 kit
GMF-7081-AC	1970-81 Factory A/C	173.99 kit



IBT-GM-BLK

1973-81 OEM Style Rubber Floor Mats

Correct factory style rubber floor mats with ribbing and GM logo. *Will Fit Most 1967-81

IBT-GM-BLK	1973-81 Black.....	99.95 set
IBT-GM-CAR	1973-81 Carmine.....	99.95 set
IBT-GM-TAN	1973-81 Tan.....	99.95 set
IBT-GM-GRY	1973-81 Gray.....	99.95 set
IBT-GM-BLU	1973-81 Dark Blue	99.95 set
IBT-GM-LTBLU	1973-81 Light Blue.....	99.95 set
IBT-GM-RED	1973-81 Red.....	99.95 set



IBT-001

Vinyl Floor Mats

GM Restoration vinyl floor mats complete with raised "bowtie" and correct grain. Black only.

IBT-001	1967-72 4pc	174.99 set
---------	-------------------	------------

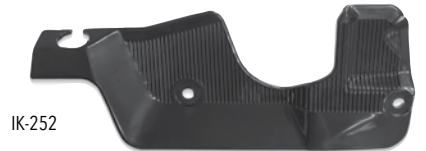

IK-252

Carpet Firewall Guard

Correct plastic injection molded piece which installs below steering column.

IK-252	1967-69 All	27.99 ea.
IK-253	1970-81 All	32.99 ea.
IN-197	1967-81 All Screws	6.99 pr.

Looking to replace your Camaro carpet with something that meets your quality and originality standards? Look no further than our ACC brand OEM carpet sets. We are proud to offer these carpets in several styles, from factory original 80/20 rayon and nylon looped blend (cut pile for 1974-77 models) to our new ESSEX Style for those who are looking for a "modern" auto style carpet seen in high end Mercedes or Porsche cars, to our "Mass Backing" carpet sets which offer factory installed sound deadening material built in for an overall quieter, cooler and more comfortable interior.

ICC-679

ALL of our ACC brand carpets are factory molded with correct heel pad & dimmer switch grommet for a model specific fit.

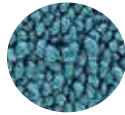

80/20 Looped



Cutpile



Essex



ICC-745T-801

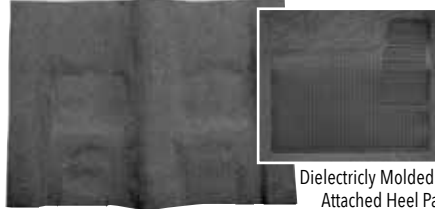

Dielectrically Molded & Attached Heel Pad



Mass-Backed Carpet shown which offer factory installed sound deadening material built in.



80/20 Looped Carpet Colors



Cutpile Carpet Colors



Molded Carpet

ICC-679	1967-69 80/20 Loop Carpet Only	158.99 ea.
ICC-705	1970-73 Auto w/o Tail 80/20 Loop Carpet Only	158.99 ea.
ICC-705T	1970-73 Auto w/ Tail 80/20 Loop Carpet Only	158.99 ea.
ICC-7054	1970-73 4 Spd 80/20 Loop Carpet Only	158.99 ea.
ICC-7054T	1970-73 4 Spd w/ Tail 80/20 Loop Carpet Only	158.99 ea.
ICC-745-801	1974-75 Auto Cutpile Carpet Only	154.99 ea.
ICC-745T-801	1974-75 Auto w/ Tail Cutpile Carpet Only	162.99 ea.
ICC-7454-801	1974-75 4 Spd Cutpile Carpet Only	154.99 ea.
ICC-7454T-801	1974-75 4 Spd w/ Tail Cutpile Carpet Only	162.99 ea.

Molded Carpet w/ Sound Deadener

IXC-6775	1967-69 80/20 Loop Carpet & Sound Deadener	183.29 kit
IXC-7075	1970-73 Auto 80/20 Loop Carpet & Sound Deadener	192.58 kit
IXC-7075T	1970-73 Auto w/ Tail 80/20 Loop Carpet & Sound Deadener	192.58 kit
IXC-70754	1970-73 4 Spd 80/20 Loop Carpet & Sound Deadener	192.58 kit
IXC-70754T	1970-73 4 Spd w/ Tail 80/20 Loop Carpet & Sound Deadener	192.58 kit
IXC-7454	1974-75 Auto Cutpile Carpet & Sound Deadener	188.98 kit
IXC-7454T	1974-75 Auto w/ Tail Cutpile Carpet & Sound Deadener	196.18 kit
IXC-7454	1974-75 4 Spd Cutpile Carpet & Sound Deadener	188.98 kit
IXC-7454T	1974-75 4 Spd w/ Tail Cutpile Carpet & Sound Deadener	196.18 kit

Sound Deadener Only

ICK-0136	1967-69 Sound Deadener Only	54.99 kit
ICK-0137	1970-81 Sound Deadener Only	54.99 kit

USE YOUR PHONES CAMERA OR ANY QR APP & SCAN NOW TO SHOP FOR THE CARPET YOU NEED!



Use the all new ACC Carpet Configurator on SS396.com

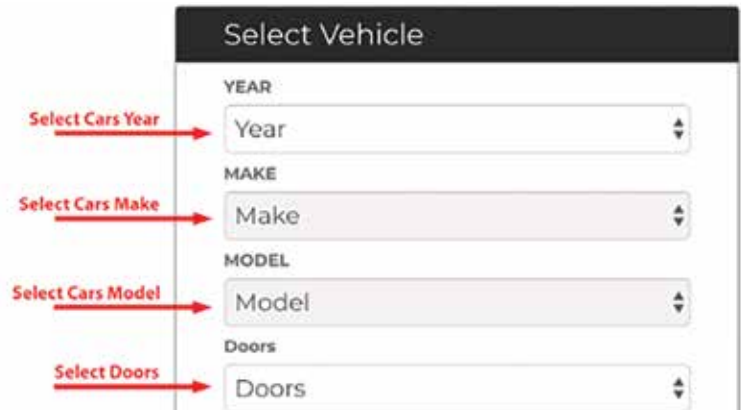

Note: Due to variations in printing, it is impossible to perfectly represent carpet colors in this catalog. Use our color swatch chart as a guide only. We will gladly mail you a color sample before you place your order upon request. Please note that colors other than black are non-returnable.

BUY'N SAVE
WITH KITS



THIS IS AN EXCLUSIVE
GROUND UP PRODUCT

Ultra-Mat Sound Deadener Kits By Repops

These kits are pre-cut for your application and bring this advanced sound deadening technology right to your garage and into your car. Pre-cut with detailed instructions to make for a trouble free installation. These kits include pieces for the floors, doors and roof insulation.

CA701ULT	1967 Complete Kit.....	229.99 kit
CA702ULT	1968-69 Complete Kit.....	229.99 kit
CA136ULT	1968-69 Floor Only Kit.....	129.99 kit
CA703ULT	1970-81 Complete Kit.....	229.99 kit
CA137ULT	1970-81 Floor Only Kit.....	139.99 kit

Ships oversize. No volume discount.



Flatline Barriers

Flatline Barriers is the new leader in automotive thermal acoustic insulation products. Utilizing cutting edge technology and materials, Flatline is able to offer a solution that significantly reduces unwanted sound and heat. Did we mention that the product is ultra-lightweight as well? Extremely lighter than other insulation products, packing the same punch in sound and heat control properties. The material is also offered in pre-cut kits and universal options. Our designs were created by in house automotive enthusiasts and DIYers. Making our kits easy to install, logical in layout and highly effective. All of this provided to you at an extreme value. Remember the name is Flatline, it's that quiet

IFL-TABF2013	1967 Complete Kit Coupe.....	281.99 kit
IFL-TABF2016	1967 Complete Kit Convertible.....	249.99 kit
IFL-TABF2014	1968-69 Complete Kit Coupe.....	281.99 kit
IFL-TABF2016	1968-69 Complete Kit Convertible.....	249.99 kit
IFL-TABF2015	1970-81 Complete Kit.....	333.99 kit
IFL-TABF2005	1967 Doors/Quarter Panel.....	120.99 kit
IFL-TABF2003	1968-69 Doors/Quarter Panel.....	120.99 kit
IFL-TABF2004	1970-81 Doors/Quarter Panel.....	120.99 kit
IFL-TABF2001	1967-69 Roof.....	52.99 kit
IFL-TABF2002	1970-81 Roof.....	102.99 kit
IFL-TABF2011	1967-69 Floor.....	141.99 kit
IFL-TABF2012	1970-81 Floor.....	164.99 kit
IFL-TABF2007	1967 Trunk.....	92.99 kit
IFL-TABF2011	1968-69 Trunk.....	141.99 kit
IFL-TABF2012	1970-81 Trunk.....	164.99 kit

No volume discount.

CONSOLES

Classic Consoles

Do you enjoy cruising in your classic muscle car but get frustrated by the lack of drink holders and storage space? These consoles are easy to install with no tools or drilling (easy removal for car shows) and look like they could have been factory.

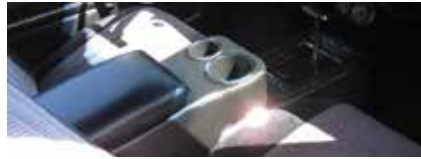

Saddle Console

- Slides over factory console with no tools or drilling
 - 1 large & 1 can-sized drink holder • Storage compartment
 - Comfortable arm rest
- | | | |
|-------------------|--------------|------------|
| CC-CAMS67-(COLOR) | 1967..... | 136.99 ea. |
| CC-CAMS69-(COLOR) | 1968-69..... | 136.99 ea. |



Holdster Console

CC-7381HLD

- Replaces stock arm rest using basic hand tools
 - 1 drink holder • Storage compartment • Comfortable arm rest
- | | | |
|----------------|---------------------------|-----------|
| CC-7381HLD-245 | 1973-76 Black Madrid..... | 90.99 ea. |
| CC-7381HLD-244 | 1977-81 Black Sierra..... | 90.99 ea. |



CC-CAMHH67

Humphugger Console for Buckets

- 1 large & 1 can-sized drink holder • Storage compartment
 - Comfortable arm rest
- | | | |
|--------------------|------------------|------------|
| CC-CAMHH67-(COLOR) | All Buckets..... | 137.99 ea. |
|--------------------|------------------|------------|

Plug & Chug Drink Holder

- Designed to fit the factory ash tray slot
 - Simply slide out ash tray and insert drink holder
- | | | |
|------------------|--------------|-----------|
| CC-CAMPC67-COLOR | 1967-68..... | 49.99 ea. |
| CC-CAMPC69-COLOR | 1969..... | 49.99 ea. |

Classic Console Colors

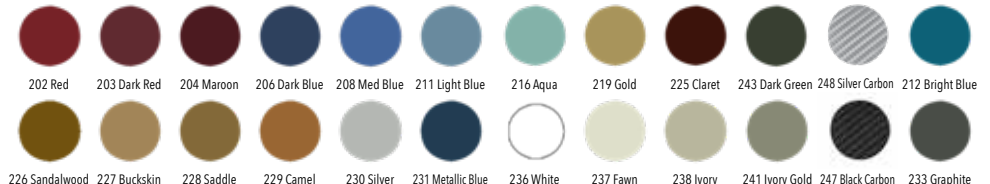

202 Red 203 Dark Red 204 Maroon 206 Dark Blue 208 Med Blue 211 Light Blue 216 Aqua 219 Gold 225 Claret 243 Dark Green 248 Silver Carbon 212 Bright Blue
226 Sandalwood 227 Buckskin 228 Saddle 229 Camel 230 Silver 231 Metallic Blue 236 White 237 Fawn 238 Ivory 241 Ivory Gold 247 Black Carbon 233 Graphite

Note: It is impossible to perfectly represent console colors. We will gladly mail you a color sample before you place your order upon request. Please note that colors other than black are non-returnable.



TMI Consoles

TMI Consoles are convenient cup holders and a storage area and are available in factory grains and colors. Available with or without chrome trim. Works on cars with or without a factory console!

Standard Single Color without Chrome

TMI-CCAS679-0041 1967-69..... 151.99 ea.

Deluxe Single Color with Chrome

TMI-CCAD679-0014 1967-69..... 205.99 ea.



Black 2295 Red 3048 Red 3597 Turquoise Met. 3046 Dark Green 3606
Parchment/Off-White 3047 Parchment/Pearl Metallic 3295 Ivory/Bright White 2305 Light Blue Met. 2309 Light Yellow Met. 3049
Med. Blue Met. 3297 Dark Blue 3598 Granada Gold 3025 Ivy/Green Gold 3307 Med. Green 3603



TMI-CSCAD67-0091

TMI-CSRCA67-0110

TMI Full Length Consoles

TMI's new Sport Full Length Console, this full length console allows you to retain your stock console gauges and shift plate and is a great complement to your original style seats.

1967 Deluxe w/ Chrome Strip

TMI-CSCAD67-0091 Black..... 594.99 ea.

1967 Standard w/o Chrome Strip

TMI-CSCA67-0051 Black..... 517.99 ea.

1968-69 Deluxe w/ Chrome Strip

TMI-CSCAD689-0102 Black..... 594.99 ea.

1968-69 Standard w/o Chrome Strip

TMI-CSCA689-0070 Black..... 517.99 ea.

TMI Sport R Full Length Consoles

TMI's new Sport R Console for the Camaro hold on to the iconic styling cues that make a Camaro interior so easily recognizable.

1967 Camaro

TMI-CSRCA67-0109 Black w/ Red Stitch..... 594.99 ea.

1968-69 Camaro

TMI-CSRCA689-0114 Black w/ Red Stitch..... 594.99 ea.



1967 Console Shells

IC-81

Injection molded, die cast reproduction of the original console shell manufactured to OE factory dimensions with correct etched grain. Includes correct chrome die-cast outer trim.

IC-85 1967 w/ Gauges.....389.99 ea.
 IC-81 1967 w/o Gauges.....389.99 ea.
Ships Oversize. No Volume Discount



IK-625KIT

1967 Console Gauge Kit

This unique gauge package contains everything you need to replace or add original type console gauges. This complete assembly includes the console gauge bezel, bottom gauge housing, fuel gauge, temperature gauge, amp gauge, oil gauge and clock pre-assembled and ready to install.

Note: If console gauges are being added to non console vehicle, new wiring will be needed.

IK-625KIT 1967 All.....527.99 ea.
No Volume Discount



IR-755G

1968-69 Automatic Console Kit

Add a factory style console to your Camaro or replace your old one with this complete automatic console kit!

Each kit includes:

- Console Shell
- Shift Plate
- Rear Lamp
- Seat Belt Retainer
- Ash Tray Insert
- Lid
- Forward Plate w/ Emblem or Gauge Package
- Mounting Bracket
- Mounting Hardware
- Reflector
- Shifter Slider w/ Retainer
- Ash Tray Lid w/ Stoppers & Pins
- Lid Hinge
- Lid Spring

IR-750P 1968 Powerglide..... 477.78 kit
 IR-750PG 1968 Powerglide w/ Gauges..... 749.59 kit
 IR-750 1968 TH350 or TH400..... 478.68 kit
 IR-750G 1968 TH350 or TH400 w/ Gauges... 750.49 kit
 IR-755P 1969 Powerglide..... 477.78 kit
 IR-755PG 1969 Powerglide w/ Gauges..... 749.59 kit
 IR-755 1969 TH350 or TH400..... 478.68 kit
 IR-755G 1969 TH350 or TH400 w/ Gauges... 750.49 kit
Ships Oversize. No Volume Discount



IR-756

1968-69 4 Speed Console Kit

Add a factory style console to your Camaro or replace your old one with this complete 4 speed console kit!

Each kit includes:

- Console Shell
- Tunnel
- Rear Lamp
- Reflector
- Lid
- Lid Spring
- Shifter Plate w/ Emblem
- Ash Tray Lid w/ Stoppers & Pins
- Shift Plate w/ Emblem or Gauge Package
- Mounting Bracket
- Mounting Hardware
- Seat Belt Retainer
- Ash Tray Insert
- Lid Hinge

IR-753 1968 4 Speed..... 442.71 kit
 IR-753G 1968 4 Speed w/ Gauges..... 714.52 kit
 IR-756 1969 4 Speed..... 446.32 kit
 IR-756G 1969 4 Speed w/ Gauges..... 718.13 kit
Ships Oversize. No Volume Discount



IC-6869

1968-69 Console Shells

Top quality reproduction injection molded console which includes the complete top shell and bottom base sections manufactured in the correct grain and contour.

IC-6869 1968-69 All.....179.99 ea.
Ships Oversize. No Volume Discount



IK-689A

1968-69 Console Gauge Kit

This unique gauge package contains everything you need to replace or add original type console gauges. This complete assembly includes cover, bezels, base, lenses, fuel gauge, temperature gauge, battery gauge and oil gauge pre-assembled and ready to install.

Note: If console gauges are being added to non console vehicle, new wiring will be needed.

IK-689A 1968-69 All.....339.99 ea.
 1596409 1968-69 Low Fuel Sender Only.....49.99 ea.
No Volume Discount



IE-069

1967-69 Console Lid

OE style reproduction metal console lids featuring correct etched grain.

IK-523 1967.....64.99 ea.
 IE-069 1968-69.....38.99 ea.

Console & Console Gauge Wiring

If your Camaro did not originally come with a console or came with a console but not gauges, you will need to order one or two of the following harnesses.

Console Gauge Harness

(needed when adding console gauges)

Connects gauges to console harness.

32640	1967 A/T Column Shift.....	106.99 ea.
32635	1967 A/T Console Shift.....	106.99 ea.
32630	1967 M/T All.....	106.99 ea.
32655	1968 A/T Column Shift.....	106.99 ea.
32650	1968 A/T Console Shift.....	106.99 ea.
32645	1968 M/T All.....	106.99 ea.
32670	1969 A/T Column Shift.....	106.99 ea.
32665	1969 A/T Console Shift.....	106.99 ea.
32660	1969 M/T All.....	106.99 ea.

Console Harness

(needed when adding a console)

Connects console to dash harness.

10790	1967 A/T.....	45.99 ea.
10795	1967 A/T w/ Gauges.....	73.99 ea.
10800	1967 M/T.....	19.99 ea.
10805	1967 M/T w/ Gauges.....	55.99 ea.
11945	1968 A/T.....	44.99 ea.
11950	1968 A/T w/ Gauges.....	69.99 ea.
11940	1968 M/T.....	19.99 ea.
11955	1968 M/T w/ Gauges.....	55.99 ea.
17510	1969 A/T.....	44.99 ea.
13085	1969 A/T w/ Gauges.....	69.99 ea.
17505	1969 M/T.....	19.99 ea.
13090	1969 M/T w/ Gauges.....	55.99 ea.
17515	1970-73 A/T.....	34.99 ea.
17505	1970-73 M/T.....	19.99 ea.
15650	1979-81 Auto Shift Indicator.....	19.99 ea.

A/T = Automatic Transmission M/T = Manual Transmission



IC-798

1970-72 Console Assembly

OE style reproduction console assembly manufactured from all new tooling. Each part is injection molded and assembled allowing easier installation. Includes upper and lower sections, side air vents, ash tray lid, console door assembly and lock assembly.

IC-798 1970-72 All.....380.99 ea.
Ships Oversize. No Volume Discount



IC-930M

1973-81 Console Shell

Complete one piece console assembly for 1973-81 Camaro.

IC-930M 1973-81 Manual.....339.99 ea.
 IC-930A 1973-81 Automatic.....339.99 ea.
Ships Oversize. No Volume Discount



IK-328

1970-72 Console Lid

OE style reproduction made from new tooling with correct grain. Includes latch and button.

IK-328 1970-7289.99 ea.



ICL-554

1973-81 Console Lid

Urethane reproduction of the original padded console lid. Paint to match.

ICL-554 1973-8136.95 ea.



ICL-555

1982-92 Console Lid

OE style reproduction with the correct grain and finish.

ICL-555 1982-92 All Black174.99 ea.

* Please Call for Colors



ICG-562

1973-81 Console Glove Box Assembly

Correct inner console glove box assembly.

ICG-562 1973-8141.99 ea.



IK-217



IK-53



I-711

1967-69 Console Lid Hardware

OE style reproduction console lid hinge.

IK-866 1967 Hinge18.99 ea.

IK-217 1968-69 Hinge17.99 ea.

I-711 1968-69 Arm9.99 ea.

IK-53 1968-69 Spring2.99 ea.



ICD-68F

Heater Console Duct

Installed on all factory console cars. Attaches to heater box to distribute heat evenly in driver and passenger areas. Made of durable fiberglass which looks original.

ICD-68F 1968-69109.95 ea.



IE-895



IK-037

1967 Shift Plates

OE style reproduction shift plates with correct semigloss satin black paint with triple chrome plated outer trim.

IK-037 1967 Automatic 2pc49.99 ea.

IE-895 1967 Manual 1pc52.99 ea.

ISP-490 Screws 4pc4.99 kit



IQ-345W



IQ-368

1968 Shift Plates

OE style reproduction shift plates with correct walnut woodgrain with chrome plated outer trim.

IQ-345W 1968 Automatic47.99 ea.

IQ-368 1968 Manual62.99 ea.

ISP-490 Screws (4)4.99 kit



IQ-345R



IQ-370

1969 Shift Plates

OE style reproduction shift plates with correct cherry woodgrain with chrome plated outer trim.

IQ-345R 1969 Automatic47.99 ea.

IQ-370 1969 Manual62.99 ea.

ISP-490 Screws (4)4.99 kit



IC-877



IW-476

1970-72 Shift Plates

OE style reproduction die cast shift plates. 1970-71 manual features shift emblem and 1972 does not as original.

IC-877 1970-72 Automatic79.99 ea.

IW-476 1970-71 Manual74.99 ea.

IW-477 1972 Manual69.99 ea.

ISP-490 Screws 4pc4.99 kit



ISP-779



ISP-852

1973-81 Shift Plates

OE style reproduction shift plates. 1973-78 features a shift pattern in the dash so the plate has no pattern. 1979-81 features the shift pattern on the shift plate as original.

ISP-779 1973-78 Auto69.95 ea.

ISP-852 1979-81 Auto89.99 ea.

ISP-491 Screws 4pc4.99 kit



ISP-839A



ISP-839M

1983-92 Shift Plates

Correct reproduction shift plates with correct color lettering. Comes complete with slider (auto) or boot (manual 5 speed). 83-89 Models feature white lettering, 90-92 has yellow lettering.

ISP-839A 1983-89 Auto183.99 ea.

ISP-839M 1983-89 Manual189.99 ea.

ISP-902A 1990-92 Auto188.99 ea.

ISP-902M 1990-92 Manual181.99 ea.



IFP-89W



IFP-89R



IK-614

1968-69 Forward Plates

Excellent quality reproduction woodgrain forward plates and correct emblem.

IFP-89W 1968 Walnut Plate23.99 ea.

IFP-89R 1969 Cherrywood Plate23.99 ea.

IK-614 1968-69 Bowtie Emblem13.99 ea.



IQ-65

4 Speed Emblem

Correct 4 speed console emblems.

IQ-65 1968-6915.99 ea.



ISP-F685R

5 & 6 Speed Emblem

5 or 6 speed emblems that look stock!

ISP-F685T	68-69 Tremec 5 Speed	51.99 ea.
ISP-F685R	68-69 Richmond 5 Speed.....	51.99 ea.
ISP-F686T	68-69 Tremec 6 Speed.....	51.99 ea.
ISP-F686R	68-69 Richmond 6 Speed.....	51.99 ea.



ISS-6F



ISSFT-HRDW

Staple Shifter

Complete staple shifter assembly with chrome plated handle, spring loaded lock out trigger and mounting base. Ready to install.

ISS-6F	1968-69 Assembly.....	139.99 ea.
ISH-640	1970-72 Assembly.....	162.99 ea.
ISH-3X	1968-72 Handle Only.....	79.99 ea.
ISSFT-HRDW	1968-72 Repair Kit.....	32.99 kit

No Volume Discount



IK-210



IK-209



IQ-344

Shift Bulb Mounting & Backing Plates

Correct shift plate bulb retainers.

IK-210	1967 Mounting Plate	13.99 ea.
IK-209	1967 Backing Plate.....	8.99 ea.
IQ-344	1968-69 Mounting Plate.....	9.99 ea.
IQ-342	1968-69 Shift Lens Backing Plate...	8.99 ea.



IQ-343

Console Shift Plate

OE style reproduction shift plate insert featuring flat black paint with raised chrome edges and installation nuts.

IQ-343	1968-69	29.99 ea.
IK-51	1968-72 Shift Plate Seal Kit.....	17.99 kit

BUY'N SAVE WITH KITS



SHIFTKIT-F63

Console Shifter Kit

Complete kit to convert to an automatic console shifter. Kit includes factory style staple shifter, cable, brackets & all correct hardware.

SHIFTKIT-F63	1968-69 TH350.....	202.16 kit
SHIFTKIT-F64	1968-69 TH400.....	202.16 kit
SHIFTKIT-F73	1970-72 TH350.....	221.71 kit
SHIFTKIT-F74	1970-72 TH400.....	221.71 kit

No Volume Discount

SC2244



4 Speed Overdrive Kits

This kit makes it easy to install a modern overdrive automatic in place of your old Powerglide, TH350 or TH400 for improved performance and gas mileage. Each kit includes a new laser cut and hardened detent, indicator plate, hardware and brackets to allow the use of your factory shifter. This kit works with a TH700, TH200 or 4L60 transmission.

SC2244	1968-69.....	99.95 kit
SC2245	1970-72.....	99.95 kit
SC2261	1973-78.....	99.95 kit
SC2262	1979-81.....	99.95 kit

IQ-110P



IQ-110T



Shift Indicator Lenses

Injection molded clear shift indicator lenses.

IQ-109	1967 Powerglide	9.99 ea.
IQ-127	1967 TH350/TH400.....	6.99 ea.
S121	1967 700-R4/200-4R.....	18.95 ea.
IQ-110P	1968-69 Powerglide.....	7.99 ea.
IQ-110T	1968-69 TH350/TH400.....	8.99 ea.
S150	1968-69 Reverse Pattern	24.95 ea.
S120	1968-69 700-R4/200-4R	19.95 ea.



IC-123



IC-45



IC-124

Shifter Sliders

Correct die stamped plastic shifter sliders.

IC-123	1967 Manual	7.99 ea.
IC-45	1967 Automatic	7.99 ea.
IW-340	1967 Slider Retainer.....	6.99 ea.
IC-124	1968 Manual.....	7.99 ea.
IC-158	1968 Slider Retainer.....	12.99 ea.



IQ-341

Shifter Tunnel

Correct molded plastic which installs on inside of console.

IQ-341	1969 4 Speed	24.99 ea.
IQ-964	1970-72 4 Speed	29.99 ea.
IQ-571	1973-81 4 Speed.....	44.99 ea.



ICE-09



ICE-4526



IK-407



ICE-HURST

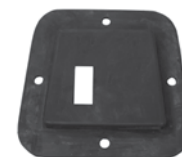

ICE-3966



ICE-78UP

Shifter Boots

Brand new injection molded boots.

ICE-09	1967-68 w/o Console.....	26.99 ea.
ICE-4526	1967-68 w/ Console.....	22.95 ea.
IK-8UP	1968 Upper w/ Console.....	8.99 ea.
IK-407	1969 All	22.95 ea.
ICE-3966	1970-81 Lower.....	23.99 ea.
ICE-78UP	1970-81 Upper.....	22.95 ea.
ICE-HURST	Universal.....	59.99 ea.



Shift Boot Retainers

Correct die stamped steel boot retainers.

IQ-635	1967-68 w/o Console 2pc.....	43.99 ea.
IK-476	1967-68 w/ Console.....	17.99 ea.
ICE-1516	1969 w/o Console Black.....	12.99 ea.
ICE-1562	1969 w/ Console Chrome.....	16.99 ea.
IW-764	1970-81 All.....	21.99 ea.



IK-218

Console Ash Tray Lids

OE style reproduction die cast rear lid.

3898867	1967	27.99 ea.
IK-218	1968-69.....	21.99 ea.



IK-155

Console Ash Tray Insert

Correct rear console ash tray insert.

IQ-235	1967	11.99 ea.
IK-155	1968-72.....	14.99 ea.



3893867

Console Ash Tray Hardware

Correct ash tray springs & hinge pins.

3893867	1967 Pins.....	6.99 pr.
3919075	1968-72 Pins	5.99 pr.
ICS-306	1967 Springs.....	7.99 pr.
ICS-942	1968-72 Springs.....	6.99 pr.



ISN-617

ISK-616

FW-8702

1973-02 Shift Knob

Correct reproduction automatic gearshift knob and button for models with console shift automatic.

ISN-617	1973-81 Button	13.99 ea.
ISK-616	1973-81 Knob.....	28.99 ea.
FW-8702	1987-02 Auto Leather.....	79.99 ea.



ISN-CLIP

Shift Lever Clip

Original clip for use with automatic shift levers. Attaches the shift knob to the lever. A necessary part required to install the shift knob.

ISN-CLIP	1977-86 All Auto w/ Console Shifter.....	3.99 ea.
----------	--	----------



IK-121

Console Gauge Hardware Kit

Complete 44 piece kit for assembling console gauges.

IK-121	1968-69 (44 pc.).....	9.95 kit
--------	-----------------------	----------



R2343

Console Hardware Kit

Complete console assembly trim screw kit.

R2343	1968-69.....	18.99 kit
-------	--------------	-----------



ICG-562

1973-81 Console Glove Box Assembly

Correct inner console glove box assembly.

ICG-562	1973-81.....	41.99 ea.
---------	--------------	-----------



ILB-567

1973-81 Lid Latch Button

Correct replacement assembly for the often broken or missing original.

ILB-567	1973-81.....	12.99 ea.
---------	--------------	-----------



IBS-568

1973-81 Console Lid Button Spring

Correct console lid button spring.

IBS-568	1973-81.....	4.99 ea.
---------	--------------	----------



ICLK-67F

1967 Console Clock

OE style reproduction console clock with correct face and modern quartz movement.

ICLK-67F	1967	244.99 ea.
----------	------------	------------



IK-519

Console Mounting Kit

Necessary if you have replaced the floor pan or want to add a console to your car.

IK-519	1968-69 6pc.....	8.99 kit
--------	------------------	----------



IQ-365

Console Brackets

Correct reproduction brackets for mounting console to floor.

IQ-364	1967	14.99 ea.
IQ-365	1968-69.....	14.99 ea.
IK-665	1970-72.....	59.99 ea.



IK-558

1973-81 Rear Console Cover Plate

OE style reproduction rear console cover plate.

IK-558	1973-81.....	16.99 ea.
--------	--------------	-----------



IQ-684

Rear Console Lamp Lens

OE style reproduction injection molded polypropylene replacement lens assembly.

IQ-131	1967	8.99 ea.
IQ-684	1968-69.....	8.99 ea.

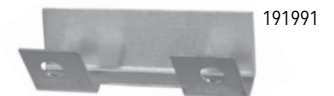

191991

Console Lamp Reflector

Correct steel console lamp reflector.

191991	1968-69.....	9.99 ea.
--------	--------------	----------

HEADLINERS

73FHC70

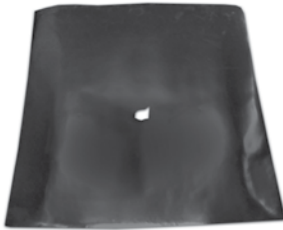

1973-92 Board Headliner

Correct board type headliner substrate covered in the correct cloth material.

- 73FHC_ 1973 197.99 kit
- IRE-82FH_C 1982-92 201.99 kit
- IRE-82FH_T 1982-92 w/ T-Top 201.99 kit
- 70 = Black, 37 = White, 38 = Red, 01 = Maroon, 03 = Dark Blue, 04 = Camel, 05 = Black, 06 = Gray, 07 = Red, 08 = Med. Gray, 1711 = Doeskin, 1769 = Charcoal. Ships Oversize 2

74FHT



1974-81 Headliner

Correct ABS substrate covered with perforated material to get your interior looking new! Insert color choice in _.

- 74FHC_ 1974-81 w/o T-Top 191.99 kit
- 74FHT_ 1978-81 w/ T-Top 191.99 kit

Note: Designed to work with Fisher T-Tops

- 18 = Navy/Med Blue, 36 = Light Saddle, 37 = White/Oyster, 90 = Light Blue*, 48 = Camel/Dark Saddle, 70 = Black, 38 = Red/Carmine/Firethorn, 35 = Saddle *Cloth

1974-81 Bow Type Headliner Conversion Kit

This kit allows you to convert from your original perforated style headliner (which often sags over the years) to the 1970-73 bow style headliner. Includes all pieces for a complete replacement. Insert color choice in _.

- UCH3-_P 1974-81 176.99 kit
- 31 = Black, 32 = Off White, 33 = Saddle, 34 = Sandalwood, 35 = Buckskin, 36 = Med Blue, 38 = Light Blue, 39 = Dark Blue, 45 = Maroon

Headliner Insulation

Correct factory style insulation to help keep noise and heat from entering car. Cut to fit.

- IHI-68 All 19.99 ea.



TMI Premium Headliner Kits with Sunvisors

This TMI headliner is made in the USA and features the factory correct grain and color for your exact application. Also included are matching side sails and Sunvisors.

1967 Camaro, Impala Grain

- TMI-HLCA67-0001 Black 223.99 kit

1968-69 Camaro, Bedford Grain

- TMI-HLCA689-0010 Black 223.99 kit

1967-69 Sport R Suede

- TMI-HLCA678-0007 Black Suede 256.99 kit



IHT-679F

1967-73 Headliner Retaining Strips

These strips retain the headliner to the roof of the car.

- IHT-679F 1967-69 Front 2pc 75.99 pr.
- IHT-679R 1967-69 Rear 3pc 97.99 kit
- IHT-679CLIP 1967-69 Clip 14pc 29.99 kit
- IHT-7081F 1970-73 Front 1pc 69.99 ea.
- IHT-7081R 1970-73 Rear 1pc 75.99 ea.
- IHT-70F 1970-73 Front & Rear 2pc 79.95 pr.

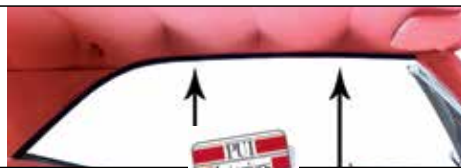

Headliners

We offer the highest quality headliners on the market. Period. They duplicate the original colors and grains exactly and come ready to install with correct cardboard covered side sails and extra material for sunvisors. Please include color choice in _.

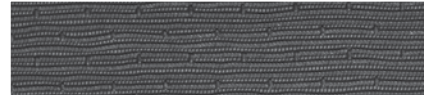

1967 Headliners

1967 Surry Line Dot

Crafted in correct surry line dot material.

- IRE-426 Black 104.99 kit
- IRE-426-67FH104 Color 100.99 kit
- 103 = Dark Red, 104 = Light Blue, 106 = Bright Blue, 118 = 67 Gold



1968-69 Headliners

1968-69 Ribbed

Crafted in correct ribbed material.

- IRE-421 Black 109.99 kit
- IRE-421-67FH_ Color 100.99 kit
- 101 = White, 103 = Dark Red, 105 = Dark Blue, 109 = Dark Green, 116 = Medium Blue, 117 = Ivy Gold

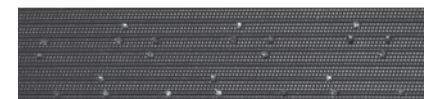

1970-73 Headliners

1970-73 Perforated

Crafted in correct perforated material.

- IRE-425 Black 72.99 kit
- IRE-425-70FH_ Color 70.99 kit
- 101 = White, 105 = Dark Blue, 106 = Bright Blue, 108 = Saddle, 109 = Dark Green, 111 = Sandalwood, 112 = Buckskin

IBC-591



IBC-12



Headliner Bow Clips

Correct style plastic bow retaining clips.

- IBC-12 1967-69 4pc 14.99 set
- IBC-591 1970-74 16pc 29.99 set

Headliner Wire Bows

OE style reproduction of these often damaged or missing steel bows.

- IHB-400 1967-69 All 68.99 set
- IHB-401 1970-73 All 55.99 set

ICH-511



ICH-753

Coat Hooks

- ICH-511 1967-77 Black 6.95 ea.
 - ICH-511K 1967-77 Black Pair* 12.95 kit
 - ICH-753 1967-77 Chrome 6.95 ea.
 - ICH-753K 1967-77 Chrome Pair* 12.95 kit
- *No Volume Discount

SUNVISORS



IRS-426

1967 Coupe Sunvisors

Superior quality sunvisors complete with metal shaft and double stitched vinyl piping in correct surry line dot material. Include color choice in _.

- IRS-426 Black 98.99 pr.
- IRS-426SV7_SC Color 98.99 pr.
- 103 = Dark Red, 104 = Light Blue, 106 = Bright Blue, 118 = 67 Gold



IRS-421B

1968 Coupe Sunvisors

Superior quality sunvisors complete with metal shaft and double stitched vinyl piping in correct ribbed material. Include color choice in _.

- IRS-421B Black 98.99 pr.
- IRS-421B_ Color 95.99 pr.
- 101 = White, 103 = Dark Red, 116 = Medium Blue, 117 = Ivy Gold



IRS-421

1969 Coupe Sunvisors

Superior quality sunvisors complete with metal shaft and double stitched vinyl piping in correct ribbed material. Include color choice in _.

- IRS-421 Black 98.99 pr.
- IRS-421SV8109R Color 95.99 pr.
- 101 = White, 103 = Dark Red, 105 = Dark Blue, 109 = Dark Green

SUNVISORS *continued*



IRS-425

1970 Sunvisors

Superior quality sunvisors complete with metal shaft and double stitched vinyl piping in correct perforated material. Include color choice in _.

- IRS-425 Black..... 94.95 pr.
 IRS-425-70FV_ Color..... 95.99 pr.
 101 = White, 102 = Bright Red, 103 = Dark Red,
 105 = Dark Blue, 106 = Bright Blue, 108 = Dark Saddle,
 109 = Dark Green, 111 = Sandalwood, 112 = Buckskin



IRS-71F

1971-73 Sunvisors

Superior quality sunvisors complete with metal shaft and double stitched vinyl piping in correct perforated material. Include color choice in _.

- IRS-71F Black..... 98.99 pr.
 IRS-71FV_B Color..... 95.99 pr.
 101 = White, 103 = Dark Red, 105 = Dark Blue,
 108 = Dark Saddle, 109 = Dark Green,
 111 = Sandalwood, 112 = Buckskin



IRS-428

1974-76 Sunvisors

Superior quality sunvisors complete with metal shaft and double stitched vinyl piping in correct Madrid material. Include color choice in _.

- IRS-428 Black..... 95.99 pr.
 IRS-428-74FV_ Color..... 95.99 pr.
 30 = Firethorn, 32 = Bright Red, 35 = Light Saddle,
 36 = Saddle, 37 = White, 41 = Sandalwood, 42 = Dark Saddle



IRS-430

1977-81 Sunvisors

Superior quality sunvisors complete with metal shaft and double stitched vinyl piping in correct Sierra material. Include color choice in _.

- IRS-430 Black..... 95.99 pr.
 IRS-430-77FV_ Color..... 95.99 pr.
 36 = Saddle, 37 = White, 38 = Carmine, 45 = Firethorn,
 48 = Camel, 66 = Silver, 90 = Light Blue, 08 = Met. Red,
 18 = Navy Blue, 81 = Oyster Z81, 86 = Oyster



IRS-67VT

1967-69 Convertible Sunvisors

Superior quality sunvisors complete with metal shaft and double stitched vinyl piping in correct vinyl material for convertible only. Include color choice in _.

- IRS-67VT Black..... 98.99 pr.
 IRS-67SV_V Color..... 95.99 pr.
 902 = Aqua, 912 = Light Blue, 914 = Bright Blue, 916 = Dark Blue,
 917 = 68 Blue, 923 = Light Green, 924 = Dk Met Green, 926 =
 Orange, 928 = Pearl, 930 = Red, 937 = White, 940 = Off White,
 943 = Gold, 946 = Ivy Gold

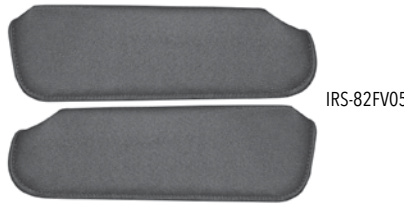

IRS-82FV05

1982-92 Convertible Sunvisors

Superior quality sunvisors complete with double stitched cloth piping in correct cloth material for convertible only. Include color choice in _.

- IRS-82FV_ 1982-92 95.99 pr. pr.
 IRS-82FV_T 1982-92 w/ T-Top or Convertible .. 95.99 pr. pr.
 01 = Maroon, 03 = Dk. Blue, 04 = Camel, 05 = Black, 06 = Lt. Gray,
 07 = Red, 08 = Med. Gray, 1711 = Doeskin, 1769 = Charcoal



IC-21

Sun visor Bushing Tip Kit

Correct bushing and tip kit for two visors.

- IC-21 1967-69 All 7.99 pr.



IBB-0753

IHQ-332

Sun Visor Supports

OE style reproduction chrome plated supports complete with screws and nylon bushing.

- IBB-0753 1967-69 Coupe..... 18.99 ea.
 IHQ-334 1967-69 Convertible Satin..... 79.99 pr.
 IHQ-332 1967-69 Convertible Chrome..... 79.99 pr.
 IVS-366 1970-78 28.99 ea.
 IVS-382 1982-82 w/o T-Tops 39.99 ea.
 IVS-382T 1982-82 w/ T-Tops* 39.99 ea.
 ISS-12545 1967-69 Screws 6 pc..... 3.95 kit
 *Does not include hardware.



DT-200007

LED Dome Light Bulb **DIGITALS**

A simple direct replacement for your dome light bulb. This LED bulb features 9 dual super bright LEDs in a 211 bulb package. Excellent to increase brightness and reduce heat and power.

- DT-200007 1967-81 211 LED Bulb 13.95 ea.

Inner Windshield Trim

Correct upper windshield moldings to finish off your interior.

- K-884 1967 All 36.95 ea.
 K-885 1968 All 39.95 ea.
 K-886 1969 All 41.99 ea.
 IHT-590* 1970-73 All 44.95 ea.

*Works with bow style headliner only. Will not work with board style headliner.



Inner Rear Window Trim

Correct molded plastic rear inner window trim.

- K-887 1967-68 All 64.95 kit
 IVK-852 1969 All 64.99 kit
 IHT-592* 1970-73 All 49.95 ea.

*Works with bow style headliner only. Will not work with board style headliner.

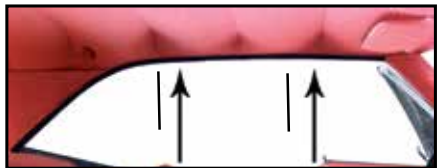

1967-69 Molded Headliner Side Trim

Correct molded urethane headliner side trim.

- IHT-58 1967 All 49.99 pr.
 IHT-68 1968-69 All 69.99 pr.



1970 - 73 Headliner Trim Kit

This is a complete headliner trim kit with front and rear molded trim and the correct metal strips for cars with bow type headliners.

- IHT-703K 1970-73 All 157.37 kit

1970-73 Headliner Retaining Strips

Correct metal strips for cars with bow type headliners.

- IHT-70F 1970-73 79.95 pr.
 IHT-7081F 1970-73 Front Only 69.99 ea.
 IHT-7081R 1970-73 Rear Only..... 75.99 ea.

REAR VIEW MIRRORS



IK-483

Rear View Mirrors

OE style reproduction polished stainless steel mirrors with day/night levers.

IM-621	1967 8" Chrome*	39.95 ea.
IK-483	1967-68 8" Chrome	49.95 ea.
IM-6810	1968-69 10" Chrome	49.95 ea.
IM-7081	1970-82 10" Chrome	55.99 ea.
IM-419B	1970-81 10" Black	59.99 ea.

*This mirror (IM-621) does not have a day/night lever.



GCS-S6065

Billet Rear View Mirror

Show quality polished billet aluminum rear view mirror features ball milled grooves and a day/night lever.

GCS-S6065	All	38.39 ea.
-----------	-----	-----------

Note: Glues to the windshield glass.



GCS-S6160

Chrome Rear View Mirror w/ Flames

Show quality chrome plated rear view mirrors feature embossed flames and a day/night lever.

GCS-S6160	w/ Red Flames	25.59 ea.
GCS-S6161	w/ Blue Flames	27.19 ea.
GCS-S6162	w/ Silver Flames	31.99 ea.
GCS-S6163	w/ Black Flames	31.99 ea.

Note: Glues to the windshield glass.



IM-6808-ML

1967-1969 Rear View Mirror w/ Map Light

Custom factory style mirror featuring a built in map light day/night lever. Mounts easily in place of your factory mirror and features correct terminal to plug into your factory fuse block.

IM-6808-ML	8" All	105.95 ea.
IM-6810-ML	10" All	105.95 ea.
IM-6812-ML	12" All	109.95 ea.



IK-23

Rear View Mirror Bracket

Correct bracket for supporting rear view mirror.

IK-23	1967 Coupe	39.99 ea.
IK-19	1967 Convertible	39.99 ea.
IK-18	1968-69 Coupe	38.99 ea.
IK-21	1968-69 Convertible	39.99 ea.
IMP-1Z	1970-81 All	6.99 ea.
IE-84Z	1970-86 Adjusting Screw	2.95 ea.



IK-25V



IK-25C

Rear View Mirror Bracket Boot

Correct cover which installs directly over the rear view mirror bracket.

IK-25C	1967 Coupe	28.99 ea.
IK-25V	1967 Convertible	28.99 ea.
IBC-68C	1968-69 Coupe	29.95 ea.
IK-22V	1968-69 Convertible	29.99 ea.

INTERIOR TRIM & ACCESSORIES



ICE-2777



INQ-0203

Dome Light Lenses

Correct white plastic lenses.

INQ-0203	1967-69 Coupe	3.99 ea.
ICE-2777	1970-81 Coupe	5.95 ea.
ICE-2789	1982-92 Coupe	9.99 ea.



IHQ-0117



ICE-0351

Dome Light Lens Bezel

New plastic molded chrome plated as original.

IHQ-0117	1967-69 Coupe	9.99 ea.
ICE-0351	1970-81 Coupe	11.95 ea.
ICE-0532	1982-92 Coupe	39.99 ea.
IBU-11A	Bulb All	2.95 ea.



IHQ-0117K

Dome Lamp Kit

Complete kit with new plastic molded and chrome plated dome light lens bezel, lens, bulb terminals and harness extension.

IHQ-0117K	1967-69 All	39.95 kit
ICE-0351K	1970-81 All	39.95 kit



IDL-CLIP

Dome Lamp Harness Clips

Correct clips for flat ribbon dual wire.

IDL-CLIP	Most GM Cars	9.99 ea.
----------	--------------	----------



I-2194A

1967 Quarter Dome Lamp Kit

Complete quarter dome light kit for 1967 deluxe interior including lenses, bezels, sockets and bulbs for a complete replacement.

I-2194A	1967 w/ Deluxe Interior	49.95 kit
---------	-------------------------	-----------



Dome Light Harnesses

Correct dome light harness.

13870	1967-69 All	21.99 ea.
17575	1970-73 All	32.99 ea.



BULB-67FI

Interior Bulb Kits

Vehicle specific kits include the following bulbs conveniently bagged & labeled.

1967-68

BULB-67FI 1967-6819.95 kit
 (6) Instrument Cluster, (2) Turn Signal Indicator, (1) Oil Pressure Indicator, (1) Headlamp Motor Warning, (1) Temp Indicator, (1) Alternator Indicator, (2) Courtesy Light, (1) Radio, (1) Heater / A/C Control, (1) High Beam Indicator, (1) Parking Brake Indicator, (1) Console Lamp, (1) Glovebox Compartment, (1) Underhood Lamp, (1) Dome Lamp

1969

BULB-69FI 196923.95 kit
 (5) Instrument Cluster, (2) Turn Signal Indicator, (1) Oil Pressure Indicator, (1) Temp Indicator, (1) Clock, (1) Alternator Indicator, (1) Map Light, (2) Courtesy Light, (1) Radio, (1) Heater / A/C Control, (1) High Beam Indicator, (1) Parking Brake Indicator, (1) Console Lamp, (1) Glovebox Compartment, (1) Underhood Lamp, (1) Trunk Lamp, (1) Dome Lamp

1970

BULB-70FI 197019.95 kit
 (3) Instrument Cluster, (2) Turn Signal Indicator, (1) Oil Pressure Indicator, (1) Temp Indicator, (1) Alternator Indicator, (1) Gearshift Indicator, (1) Radio, (1) Radio w/ Tape Player, (1) Heater / A/C Control, (1) High Beam Indicator, (1) Parking Brake Indicator, (1) Windshield Washer Indicator, (1) Console Lamp, (1) Glovebox Lamp, (1) Underhood Lamp, (1) Trunk Lamp, (1) Dome Lamp

1971-72

BULB-71FI 1971-7223.95 kit
 (3) Instrument Cluster, (2) Turn Signal Indicator, (1) Oil Pressure Indicator, (1) Temp Indicator, (1) Map Light, (2) Gearshift Indicator, (1) Radio w/ Tape Player, (1) Heater w/ A/C Control, (1) High Beam Indicator, (1) Windshield Washer Indicator, (1) Console Lamp, (1) Glovebox Compartment, (1) Underhood Lamp, (1) Trunk Lamp, (1) Dome Lamp



IK-901

Pillar Post Moldings

New injection molded moldings in correct factory styles and grains or chrome.

IK-901	1967 Coupe Black.....	69.99 pr.
IK-902	1967 Coupe Chrome.....	79.99 pr.
IK-903	1967 Convertible Black.....	67.99 pr.
IK-904	1967 Convertible Chrome.....	78.99 pr.
IK-601	1968 Coupe.....	99.99 pr.
IK-602	1968 Convertible.....	99.99 pr.
IK-962	1969 Coupe.....	103.99 pr.
IK-965	1969 Convertible.....	117.99 pr.



IHS-F70



IHS-F75R



IHS-F75L

1970-81 Side Sails

OE style reproduction side sails manufactured in the correct grain.

IHS-F70	1970-74 Black.....	136.95 pr.
IHS-F70R	1970-74 Red.....	136.95 pr.
IHS-F70T	1970-74 Tan.....	136.95 pr.
IHS-F70W	1970-74 White.....	136.95 pr.
IHS-F75L	1975-81 LH Black.....	69.95 pr.
IHS-F75R	1975-81 RH Black.....	69.95 pr.
IHS-F75LR	1975-81 LH Red.....	69.95 pr.
IHS-F75RR	1975-81 RH Red.....	69.95 pr.
IHS-F75LT	1975-81 LH Camel.....	69.95 pr.
IHS-F75RT	1975-81 RH Camel.....	69.95 pr.
IHS-F75LW	1975-81 LH White.....	69.95 pr.
IHS-F75RW	1975-81 RH White.....	69.95 pr.



IN-107

Fisher T-Top Grommet

Correct injection molded grommet replaces GM number 20066276. Four required per car.

IN-107	1978-81.....	7.95 ea.
--------	--------------	----------



IN-501K

1978-1981 Fisher T-Top Molding & End Caps

Includes 2 large U-shaped moldings & 4 end caps. These pieces go around and hold up the headliner to finish off the T-Tops. Injection molded as original GM with correct grain. Black only, paint to match.

IN-501K	Complete Kit 6pc.....	199.95 kit
IN-501	Surrounds Only 2pc.....	99.95 pr.



IN-3371

Fisher T-Top Y Moldings

Injection molded as original GM with correct grain.

IN-3371	1978-81.....	69.95 pr.
---------	--------------	-----------

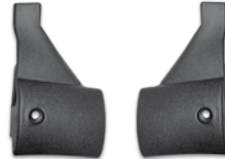

IN-664

Fisher T-Top Front Insert Trims

Correct front insert trims constructed of ABS plastic.

IN-664	1978-81.....	89.95 pr.
--------	--------------	-----------



IN-519

Fisher T-Top Rear Insert Trims

Correct rear insert trims constructed of ABS plastic.

IN-519	1978-81.....	89.95 pr.
--------	--------------	-----------



IN-519R

Fisher T-Top Rail Trim Covers

Correct injection molded rail trim covers in factory colors.

IN-519BL	1978-81 Blue.....	123.95 pr.
IN-519T	1978-81 Tan.....	123.95 pr.
IN-519R	1978-81 Red.....	123.95 pr.
IN-519BK	1978-81 Black.....	123.95 pr.



ITC-78F

Fisher T-Top Clip

Correct rust resistant stainless steel clip. Mounts to body to allow T-Top to lock into it.

ITC-78F	1978-81.....	7.95 ea.
---------	--------------	----------



ITH-78F

Fisher T-Top Handles

OE style reproduction chrome handles.

ITH-78F	1978-81.....	49.95 pr.
---------	--------------	-----------



ISS-82FTT10

1976-02 T-Top Bag

This is a correct reproduction of the T-Top storage bag.

ISS-76FTT10	1976-81 T-Top Bag.....	98.99 pr.
ISS-82FTT10	1982-92 T-Top Bag.....	119.99 ea.
ISS-93FTT10	1993-02* T-Top Bag.....	44.99 pr.

* Designed to slip over the glass after the glass is mounted in the rear well area.



ISS-82FTT06S

1982-92 T-Top Sun Shade

These are correct reproductions of the T-Top sun shades

ISS-82FTTS__	1982-92 T-Top Sun Shade.....	40.99 pr.
--------------	------------------------------	-----------

01 = Maroon, 03 = Dark Blue, 04 = Camel, 05 = Black, 06 = Gray, 07 = Red, 08 = Med. Gray, 1711 = Doeskin, 1769 = Charcoal



IER-70F

1970-81 Rear Speaker Enclosure Retainer

Attaches rear speaker enclosure.

IER-70F	1970-81 All.....	7.99 ea.
---------	------------------	----------



GWC-SPK

Speaker/Trunk/Blower Motor Wire Clips

Used to hold the wiring under the dash, power trunk or trunk light wires to hinge, speaker wires to package tray or blower motor wire to vent.

GWC-SPK	1964-77 All.....	13.95 pr.
---------	------------------	-----------



IK-4351

Rear Window Corners

OE style reproduction lower rear window corners.

IK-4351	1967-69 All.....	30.99 pr.
---------	------------------	-----------

TRUNK DIVIDERS



ITD-3

Trunk Divider Boards

Correct die-stamped cardboard piece which installs between the rear seat and trunk area.

ITD-3	1967-69 All	17.99 ea.
ITD-7	1970-81 All	17.99 ea.

Ships Oversize 2. Some trimming will be required for convertible.



ITJ-44

Trunk Divider Insulation

Correct die-stamped jute insulation.

ITJ-44	1967-69 All	13.99 ea.
ITJ-55	1970-81 All	13.99 ea.

PACKAGE TRAY



JU-100

Package Tray Insulation

Correct die-stamped jute insulation.

JU-100	1967-69 All	13.99 ea.
JU-103	1970-81 All	13.99 ea.

Package Tray Hold Down Blow Out Clip

This clip is correct for all Camaro coupes to hold the package tray to the metal underbody. When the trunk was slammed, the package tray would blow up and this clip prevented that from happening.



INL-15429	1967-72 Coupe	10.99 ea.
-----------	---------------	-----------



IRE-167



IRD-71M



PACKAGE TRAY

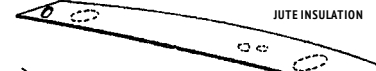

JUTE INSULATION

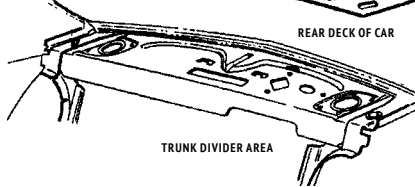

REAR DECK OF CAR

TRUNK DIVIDER AREA

Package Tray

Correct vinyl covered, die-stamped cardboard package trays. Available in standard or deluxe mesh with speaker cutouts on the underside. Insert color choice in _.

1967-69 Standard

IRE-167	1967-69 Black	19.99 ea.
IRE-67FP_	1967-69 Color	20.99 ea.
14 = Bright Blue, 17 = 68 Blue, 38 = Dark Blue, 43 = 67 Gold, 46 = Ivy Gold, 67 = Red, 69 = Light Blue, 74 = Light Aqua, 77 = Light Green, 78 = Dk Met Green		

1970-81 Standard

IRE-71	1970-81 Black	19.99 ea.
IRE-71_	1970-81 Color	20.99 ea.
14 = Bright Blue, 19 = Jade Green, 38 = Dark Blue, 41 = Sandalwood, 67 = Red, 69 = Light Blue, 77 = Light Green, 78 = Dark Met Green, 80 = Saddle/Camel		

Deluxe

IRD-167M	1967-69 Black Only	55.99 ea.
IRD-71M	1970-81 Black Only	55.99 ea.

Ships Oversize 2.



QuietRide AcoustiShield

The QuietRide AcoustiShield kit is a multi-stage automotive and sound dampening system to give your muscle car the quiet riding comfort found in today's new cars. AcoustiShield kits are designed on current state of the art auto acoustic technology to insulate and control the noise, vibration and heat in the passenger cabin. Kits are pre-cut and come with easy to follow installation instructions: Everything you need to do the job right!

The first stage consists of pre-trimmed, self-adhesive sound damper pads which are bonded to strategically located trouble spots to control body panel vibration and noise. These spots are mapped and labeled in the detailed instructions.

Complete Kits include Body, Cowl, Floor, Roof (except convertible) and Trunk Floor Kits.



1967-69 Camaro Convertible

GMF-6769-CVAK	Complete Kit	597.99 kit
GMF-6769-CVBPK	Body Kit	127.99 kit
GMF-6769-CVCK	Cowl Kit	89.99 kit
GMF-6769-CVFK	Floor Kit	228.99 kit
GMF-6769-CVTFK	Trunk Floor Kit	119.99 kit

1967-69 Camaro Coupe

GMF-6769-CAK	Complete Kit	685.99 kit
GMF-6769-CBPK	Body Kit	127.99 kit
GMF-6769-CCK	Cowl Kit	89.99 kit
GMF-6769-CFK	Floor Kit	228.99 kit
GMF-6769-CRK	Roof Kit	127.99 kit
GMF-6769-CTFK	Trunk Floor Kit	127.99 kit

1970-74 Camaro

GMF-7074-CAK	Complete Kit	685.99 kit
GMF-7074-CBPK	Body Kit	127.99 kit
GMF-7074-CCK	Cowl Kit	89.99 kit
GMF-7074-CFK	Floor Kit	228.99 kit
GMF-7074-CRK	Roof Kit	127.99 kit
GMF-7074-CTFK	Trunk Floor Kit	127.99 kit

1975-81 Camaro w/o T-Tops

GMF-7581-CAK	Complete Kit	685.99 kit
GMF-7581-CBPK	Body Kit	127.99 kit
GMF-7581-CCK	Cowl Kit	89.99 kit
GMF-7581-CFK	Floor Kit	228.99 kit
GMF-7581-CRK	Roof Kit	127.99 kit

1975-81 Camaro w/T-Tops

GMF-7581-CTAK	Complete Kit	680.99 kit
GMF-7581-CTBPK	Body Kit	127.99 kit
GMF-7581-CTCK	Cowl Kit	89.99 kit
GMF-7581-CTRK	Roof Kit	89.99 kit
GMF-7581-CTTK	Trunk Floor Kit	122.99 kit

Flatline Barriers

Flatline Barriers is the new leader in automotive thermal acoustic insulation products. Utilizing cutting edge technology and materials, Flatline is able to offer a solution that significantly reduces unwanted sound and heat. Extremely lighter than other insulation products, packing the same punch in sound and heat control properties. The material is offered in pre-cut kits and universal options. Our designs were created by in house automotive enthusiasts and DIYers. Making our kits easy to install, logical in layout and highly effective. Provided to you at an extreme value.



1967 Camaro

IFL-TABF2013	Complete Kit Coupe	281.99 kit
IFL-TABF2016	Complete Kit Convertible	249.99 kit
IFL-TABF2005	Doors/Quarter Panel	120.99 kit
IFL-TABF2001	Roof	52.99 kit
IFL-TABF2011	Floor	141.99 kit
IFL-TABF2007	Trunk	92.99 kit

1968-69 Camaro

IFL-TABF2014	Complete Kit Coupe	281.99 kit
IFL-TABF2017	Complete Kit Convertible	249.99 kit
IFL-TABF2003	Doors/Quarter Panel	120.99 kit
IFL-TABF2001	Roof	52.99 kit
IFL-TABF2011	Floor	141.99 kit
IFL-TABF2008	Trunk	92.99 kit

1970-81 Camaro

IFL-TABF2015	Complete Kit Coupe	333.99 kit
IFL-TABF2004	Doors/Quarter Panel	120.99 kit
IFL-TABF2002	Roof	102.99 kit
IFL-TABF2012	Floor	164.99 kit
IFL-TABF2009	Trunk	92.99 kit



USA-74CAM69



USA-74CAM67



USA 740AM/FM 300 Watt

The USA-740 offers the same classic look that Custom AutoSound has always been known for with today's latest features. Now, with built-in Bluetooth (microphone included), answer calls and get Bluetooth streaming music from your Bluetooth capable phone or Bluetooth compatible device. A solid 300-watt peak power should be all the juice you need, yet the USA-740 has Hi 4 volt, 4 channel RCA pre-outs and a subwoofer RCA pre-out for additional amplifiers. The USB input allows you to plug in a USB flash drive for playback of MP3/WMA/FLAC/WAV song files. A front 3.5mm mini jack auxiliary audio input and a rear RCA auxiliary audio input provide versatility for options like satellite radio, iPod or any portable player you wish to use. Match the dominant color of your instrument cluster with user selectable multiple LCD color choices with LCD dimmer control. The AM/FM RDS tuner shows station, song and artist on the LCD display. For those of us committed to music collections on compact disc, the USA-740 fully controls the optional Custom AutoSound CD-1 CD player. Classic style with today's sound and performance taking every road and curve with you in your Chevrolet.

USA-74CAM67	1967-68 All	329.99 ea.
USA-74CAM69	1969-77 All	329.99 ea.
USA-74CAM78	1978-81 All	329.99 ea.



USA-230CAM67W



USA-230CAM69



USA-230 AM/FM 200 Watts

A great look and sound at an awesome price. This USA-230 radio has no cassette but comes with Auxiliary Input for iPod, MP3, Satellite radio, etc. Classic features with a classic look. These exciting features include:

- AM/FM Stereo • 200 Watts (4 x 50) • Auxiliary Input
- Digital Clock • Electronic Tuner • 30 Pre-sets (12AM-18FM)
- 4 Channel RCA Pre-Outs • 4 Way Fader • Power Antenna Lead

USA-230CAM67	1967-68 Black Bezel	179.99 ea.
USA-230CAM67W	1967-68 Walnut Bezel	179.99 ea.
USA-230CAM69	1969-77	179.99 ea.
USA-230CAM78	1978-81	179.99 ea.



Custom Autosound USA-630 AM/FM 240 Watts

The USA-630 is the pinnacle of 30 years of evolution in Custom Autosound's quest for the perfect classic car radio. This radio has large OEM style push-buttons that give a perfect look in a classic dash. Although it looks classic it has the latest modern features. USB input on the back of the radio. This jack is on an 18" extension which allows you to place it in the glove box or ash tray for easy access (no unsightly wires or plugs hanging out of the front of the radio). The new alpha numeric display (30% larger than previous models) shows the song/artist/album (id3) titles during playback of MP3/WMA files. With the built in CD controller you have complete control (no FM modulation) of CAS's 10 disc CD changer.

With 240 watts the radio should have all the power you may need, if you want more there are four pre-outs jacks on the back of the radio for optional amplifiers. The back of the radio also has auxiliary audio input for satellite radio or any portable player you may wish to use.

- AM-FM Stereo • USA/Euro Tuner • Power Antenna Lead • Alpha Numeric id3 Display for MP3/WMA files • Electronic Tuning and Volume Control • 4 Way Fader • Left Right Balance • Digital Clock • 16 Pre-sets (12FM-4AM) • 4 Channel RCA Pre-outs • Separate Bass and Treble • 2 Channel RCA Auxiliary Input for Satellite / iPod etc.

USA-63CAM67	1967-68 Black Bezel	249.99 ea.
USA-63CAM67W	1967-68 Walnut Bezel	249.99 ea.
USA-63CAM69	1969-77	249.99 ea.
USA-63CAM78	1978-81	249.99 ea.



AAR-73CAM

Antique Auto Radios Bluetooth



If you are looking for a radio that sounds great and looks just like your original this Antique Auto Radio is perfect for you! Max power 180 watts RMS, 45W x 4 MOSFET onboard power amplifier. Analog controls look and feel just like your original. AM dial scale in foreground looks original with a FM dial scale in background. All controls easily accessible. Volume, bass, treble, balance, fader and tuning from original looking controls. Digitally tuned AM/FM/Stereo front end provides stable, high quality reception. Shafts are the original size, for quick and accurate mounting just like your original. Also included are additional line outs and output options: 3 RCA jacks for left channel, right channel and sub-woofer, a 6 foot 3.5mm male-to-male auxiliary cable, 3.5 mm phone jack for input from iPod, satellite radio or MP3 player, switch selectable for 1,2,3 or 4 speakers, switch selectable for North America or Europe mode Doesn't include a remote or a USB for a flash drive or SD card port. All Antique Automobile Radios now feature built-in Bluetooth 3.0 EDR compliance; Place and answer calls or stream your favorite programs while maintaining the original appearance! Includes a built in microphone for HFP (hands free profile calling). HSP, A2DP, AVRCP profiles are also supported.

AAR-67CAM	1967-68 All	689.99 ea.
AAR-69-GM	1969 All	689.99 ea.
AAR-70-GM	1970 All	689.99 ea.
AAR-71-CAM	1971 All	689.99 ea.
AAR-73CAM	1973 All	689.99 ea.

Custom AutoSound Sound System Kits

Crank up the tunes with Ground Up's exclusive Sound System Kits! Each kit comes with an in-dash radio, rear speakers, and dash speakers, making it easy to bundle and save while still looking and sounding great!

Basic Kits

These kits feature a USA-230 radio, front dash speakers, and rear 6x9 speakers.

SSK-678F-B	1967-68 Non AC w/ Black Bezel	278.97 kit
SSK-678F-BA	1967-68 w/ AC w/ Black Bezel	278.97 kit
SSK-678F-W	1967-68 Non AC w/ Walnut Bezel	278.97 kit
SSK-678F-WA	1967-68 w/ AC w/ Walnut Bezel	278.97 kit
SSK-69F	1969 Non AC	278.97 kit
SSK-69F-A	1969 w/ AC	278.97 kit
SSK-707F	1970-77 All	278.97 kit
SSK-7881F	1978-81 All	278.97 kit

Upgraded Kits

These kits feature a USA-630 radio, front dash speakers, and rear 6x9 speakers.

SSK-678F-B-U	1967-68 Non AC w/ Black Bezel	368.97 kit
SSK-678F-BA-U	1967-68 w/ AC w/ Black Bezel	368.97 kit
SSK-678F-W-U	1967-68 Non AC w/ Walnut Bezel	368.97 kit
SSK-678F-WA-U	1967-68 w/ AC w/ Walnut Bezel	368.97 kit
SSK-69F-U	1969 Non AC	368.97 kit
SSK-69F-A-U	1969 w/ AC	368.97 kit
SSK-707F-U	1970-77 All	368.97 kit
SSK-7881F-U	1978-81 All	368.97 kit

Premium Kits

These kits feature a USA-740 radio, front dash speakers, and rear 6x9 speakers.

SSK-678F-P	1967-68 Non A/C w/ Black Bezel	440.97 kit
SSK-678F-A-P	1967-68 With A/C w/ Black Bezel	440.97 kit
SSK-69F-P	1969 Non AC	440.97 kit
SSK-69F-A-P	1969 w/ AC	440.97 kit
SSK-707F-P	1970-77 All	440.97 kit
SSK-7881F-P	1978-81 All	440.97 kit

No volume discount.



SSK-678F-B



BUY'N SAVE
WITH KITS

SECRET-SST



BLUKIT



Secret Audio SST

Secretaudio SST is a hidden audio system that offers great flexibility for mounting in any type of vehicle. The main receiver/amplifier unit is usually hidden under the seat or behind the dash. A 10ft cord from the Tuner/Amp plugs into an LCD display. The system can be operated from up to 40 feet away with the included RF (radio frequency remote.)

Included with the system is a flush mount bezel for console or dash mounting. The small dimensions of the flush mount system allow you to install the LCD display almost anywhere. The LCD also comes with a bracket mount for easy installation in the glove box, under the dash, in the ashtray, sun visor, console or wherever you choose. Since its only 1" deep, it's especially handy for custom or streetrod applications where there may be wiring or ducting routed behind the panels you wish to utilize for mounting. When your installation is finished you'll be rewarded with a quality professionally installed look.

Features:

- AM/FM Stereo 200 watts 4x50 • Auxiliary Audio Input • USB MP3/WMA Flash Drive Player • iPod® Direct Control Interface (built into tuner/amp unit) iPod Docking Cable Included • Alpha Numeric LCD Display Shows Artist / Song Titles for USB, iPod® and Satellite Radio • Satellite Radio Input (for optional Sirius® satellite radio tuner) • Direct CD Changer Control (CD changer optional)
- 4 Channel 3 Volt RCA Pre-Outs (for optional Amplifiers) • Subwoofer Pre-Out (for optional Subwoofer Amplifier)
- Electronic Volume, Bass, Treble, Balance, Fader • 5 Selectable iEQ Curves – pop/jazz/classic/beat/rock
- Zero Memory Current Draw (will not drain car battery when unit not in use) • 24 Station pre-sets (18FM / 6AM) • Power Antenna 12V Trigger Lead

SECRET-SST 1964-72329.99 ea.

Bluetooth Interface for USA-630, Secretaudio

This adapter plugs into the CD changer port of your radio and gives you the ability to do hands free calling from your Bluetooth capable phone. You can listen to music stored on your A2DP enabled Bluetooth device. You can still use your CD changer with the adapter plugged in.

BLUKIT Bluetooth Interface 99.99 ea.

Note: Works with Custom Autosound USA-630 and Secretaudio systems.



KPS-F69-80



KPS-F69-300



Premium Quality Kick Panel Speakers

These Ground Up kick panel speakers offer great sound quality for your Camaro. These kick panels are as true to the originals as possible while offering a modern speaker in a convenient location. No cutting of the body required! Made of ABS textured plastic they can be painted to match any interior for a clean look. All speakers are 6.5" with either a 80 watt three way or a 300 watt two way speaker driver.

- KPS-F678-80 1967-68 w/o A/C 80 Watt 3 Way.... 159.95 pr.
- KPS-F678-300 1967-68 w/o A/C 300 Watt 2 Way.. 195.95 pr.
- KPS-F69-80 1969 w/o A/C 80 Watt 3 Way 159.95 pr.
- KPS-F69-300 1969 w/o A/C 300 Watt 2 Way..... 195.95 pr.
- KPS-F70-80 1970-81 w/o A/C 80 Watt 3 Way.... 159.95 pr.
- KPS-F70-300 1970-81 w/o A/C 300 Watt 2 Way.. 195.95 pr.



BKT-6774



IER-70F

1967-81 Speaker Bracket

This often missing bracket secures your speaker in place.

- BKT-6774 1967-69 Dash All32.95 ea.
- IER-70F 1970-81 Rear All 7.99 ea.



KNW-2001

Kenwood Upgraded Dash Speakers

These Custom Autosound speakers feature Kenwood quality upgrade replacement speakers for your original front in-dash speakers. These great quality speakers can handle up to 60 watts and are built and designed to fit directly under the dash including all correct mounting brackets and wiring. Each assembly includes two speakers.

- KNW-2001 1967-69 w/o AC69.99 ea.
- KNW-2002 1967-69 w/ AC69.99 ea.
- KNW-2003 1970-81 Mono.....69.99 ea.

4007



4023



Dual Voice Coil Speakers

These DVC speakers will give you the best possible sound and power handling from your stock speaker locations. They give up to 70% more cone area than a conventional dual speaker setup with 140 Watt power capacity, left and right channel hookup and tweeters.

- 4001 1967-69 w/o AC55.99 ea.
- 4007 1967-69 w/ AC55.99 ea.
- 4023 1970-81 Mono.....55.99 ea.



1013



Dash Speakers

Since at least 2 speakers are required for true stereo sound, these speakers are a perfect upgrade to OEM and do not require any modification to your dash. The 1000 series are held in place by the original screws and the 2000 series are held in place by the original bracket.

- 2001 1967-69 w/o AC39.99 ea.
- 2002 1967-69 w/ AC39.99 ea.
- 2003 1970-81 Mono.....39.99 ea.
- 1013 1970-81 Two Speakers..... 39.99 pr.



KCAM-67/8



Kick Panel Speakers

Enhance your sound quality with these custom molded ABS panels fitted with 6.5" 60 watt speakers or 6.5" coaxial 120 watt speakers They fit directly in place of your stock kick panels with no modification necessary.

- KCAM-67-8 1967-68 80W..... 116.96 pr.
- PKCAM-67-8 1967-68 120W 189.99 pr.



Rear Speakers

These rear speakers are a high performance replacement for your originals and include grilles, wires and hardware.

- SPUV-693C 6x9 3 Way 200W..... 89.99 pr.



UNDERCOVER1



Undercover Speakers

These compact speakers are specifically made for under seat installation and they pack a 120 watt punch! Each unit features a 5½" woofer and piezo tweeter. 3" H X 8-1/4" W X 11-1/4" L

UNDERCOVER1 All 129.99 pr.



UNDERCOVER2



Undercover II Speakers

Want a little more from your hidden speaker system? This is it! Each unit features an 8" woofer and 2 piezo tweeters. With the 8" woofer in UNDERCOVERII you get a much fuller deeper sound with a 200 watt capability! 11"W x 12.5"D x 3"H

UNDERCOVER2 All 165.99 pr.



BSD-CAM-680

Backseat Driver

Add some bottom end power to your system with our custom bass speaker panel. This panel comes equipped with two Custom Autosound 8" subwoofers and the Boss 500 watt amp. Panel mounts to the back of the rear seat from the trunk. All cables & wires needed are included for a quick and easy install!

BSD-CAM-680 1967-69 229.99 ea.



CAS-SYSTEM1



System 1

Flat active aluminum subwoofer enclosure with 3 channel amplifier. Two 3" mid-tweeter satellite speakers in die cast metal housings and 8" woofer. Wire remote for bass level. Amplifier installation kit included. Amplifier power: 150 watt subwoofer / 2x50 watt mid/tweeter. Dimensions: Amp / Sub: 2.8" x 13.5" x 9.8". Satellite: 3.2" x 3.75"

CAS-SYSTEM1 System 1 289.99 kit

STEREO ACCESSORIES



ANT-HIDE

Accessories

ANT-HIDE Hidden Antenna-AM/FM 29.95 ea.



ANT-01

Antenna Kits

Our kits come complete with correct cable, antenna base, gasket and mast.

- ANT-01 1967-68 Front AM/FM Fixed Mast 42.95 kit
- ANT-0026 1969 Front AM/FM Fixed Mast 42.95 kit
- ANT-0045 1967-68 Front AM Telescoping Mast 189.95 kit
- ANT-0046 1969 Front AM Telescoping Mast 189.95 kit
- ANT-0047 1967-68 Rear AM Semi Telescoping 189.95 kit
- ANT-0047FM 1967-68 Rear AM/FM Fixed Mast 44.95 ea.
- ANT-0048 1969 Rear AM Semi Telescoping 189.95 kit
- ANT-0048FM 1969 Rear AM/FM Fixed Mast 44.95 ea.
- CT-728 1967-68 Front Antenna Mounting Template 8.99 ea.
- CT-729 1969 Front Antenna Mounting Template 8.99 ea.
- CT-726 1967-69 Rear Antenna Mounting Template 8.99 ea.



GRC-12835

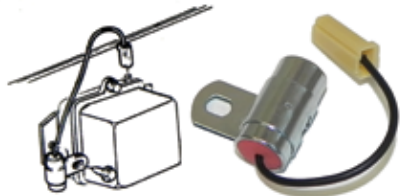

GRC-12834

Radio Capacitor

Came from the factory on all cars with radio. Correct length lead wire & brass connector.

- GRC-12834 1967-71 Voltage Regulator 29.95 ea.
- Stamped 1964086 "DR" & ".5MF"
- GRC-12835 1970-1974 Radio 29.95 ea.
- 1964452 "DR" & ".3MF"



IK-213

IK-245

IRK-712

Radio Knobs

Correct inner and outer radio knobs.

- IK-520 1967-68 Inner (Mono) 6.99 pr.
- IK-520S 1967-68 Inner (Stereo) 8.99 pr.
- IK-213 1967-68 Outer 19.99 pr.
- IK-231 1969-70 Inner (Mono) 12.99 pr.
- IK-231S 1969-70 Inner (Stereo) 12.99 pr.
- IK-245 1969-70 Outer 17.99 pr.
- IRT-712 1971-78 Inner (Mono) 26.95 pr.
- IRT-7S 1971-78 Inner (Stereo) 26.95 pr.
- IRK-712 1971-78 Outer w/ Logo 26.95 pr.



IRD-67F

1967-69 Radio Delete Plate

Originally used on specially optioned cars that did not come with a factory radio. Injection molded like original with hot stamped chrome on the edge. This is a show quality piece.

- IRD-67F 1967-68 All Black 89.99 ea.
- IRD-69F 1969 All Black 74.95 ea.

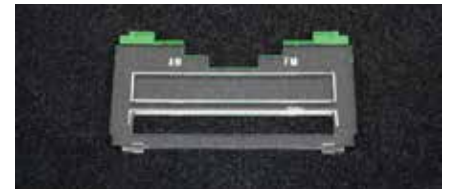

IRL-2120

Radio Lenses

Authentic reproduction radio lenses with correct lettering and colors.

- IRL-2120 1969-70 Mono, 1970 AM/FM 29.95 ea.
- IRL-2121 1969 AM/FM 29.95 ea.
- IRL-4615 1971-76 AM/FM Mono 29.95 ea.
- IRL-4616 1971-76 AM/FM Stereo 29.95 ea.



IRB-678

Radio Faceplate

Correct reproduction of the original radio bezel plate with chrome outer trim and black semi gloss paint.

- IRB-678 1967-68 All 29.99 ea.
- IRS-533 1967-68 All Screws 2.99 kit



MTB-11

Convertible Top Boot

This superior quality boot features the correct HEAVY weight vinyl and original style stitching construction. Please insert your color choice in _.

- MTB-11 1967-69 Black.....207.99 ea.
- MTB-67FT_ 1967-69 Color.....201.99 ea.
- 02 = Light Aqua, 12 = Light Blue, 14 = Bright Blue,
- 16 = Dark Blue, 17 = 68 Blue, 23 = Light Green,
- 24 = Dk Met Green, 26 = Orange, 28 = Pearl, 30 = Red,
- 37 = White, 40 = Off White, 43 = Gold, 46 = Ivy Gold



Convertible Tops

OE style reproduction convertible tops with correct grain and weight as well as seam treatment just like factory. Available with plastic window or glass window.

- MP-331B 1967-69 Black with Plastic Rear Window.....349.99 ea.
- MP-331BW 1967-69 White with Plastic Rear Window.....349.99 ea.
- MP-441B 1967-69 Black with Glass Rear Window499.95 ea.
- MP-441W 1967-69 White with Glass Rear Window499.95 ea.

No Volume Discount. Ships Oversize.



KQ-177



KQ-39

Convertible Header Molding

OE style reproduction header moldings in either chrome for 1967 models or satin for 1968-69 models. Both are interchangeable.

- KQ-177 1967 Polished Chrome..... 139.99 pr.
- KQ-39 1968-69 Satin..... 144.99 pr.
- KQB-33 Screw Kit4.99 kit



MTB-12538

Top Boot Snap Screws

Correct fine thread convertible top snap screws which are located on the rear interior quarter panels.

- MTB-12538 1967-69 4pc.....7.95 kit

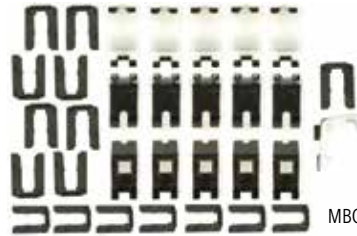

MBC-67F

Convertible Boot Clips

Correct clips for attaching boot to molding.

- MBC-67F 1967-69 16pc.....39.95 kit



MBS-1000B

Pivot Bolt Set

Correct convertible top pivot bolts.

- MBS-1000B 1967-69 46.95 kit
- MBS-227 1967-69 Main Pivot Bolts Only..... 13.99 pr.



MTC-9

Convertible Top Cables

Correct top torsion cables in matched pairs.

- MTC-9 1967-69 Convertible..... 39.95 pr.



MTP-41

Convertible Top Pads

High quality reinforcement pads which fit between the frame rails and top.

- MTP-41 1967-69 Convertible..... 49.95 pr.



IHQ-334



IHQ-332

Sunvisor Supports

OE style reproduction chrome plated supports complete with screws and nylon bushing.

- IBB-0753 1967-69 Coupe..... 18.99 ea.
- IHQ-334 1967-69 Convertible Satin..... 79.99 pr.
- IHQ-332 1967-69 Convertible Chrome..... 79.99 pr.



JSS-3043

Convertible Top Weatherstrip Kit

New state of the art Metro convertible top weatherstrip kit featuring steel frames with molded rubber, correct seams and extension flaps. Header seal has correct pins and molded corners. Made in USA.

- JSS-3043 1967 Convertible 189.95 kit
- JSS-3043-OE 1968-69 Convertible..... 189.95 set
- JSS-RR1515 1987-92 Convertible..... 449.95 kit



JSS-089

Convertible Rear Frame to Body Seals

Seals prevent water drainage into rear of body and trunk area. Molded rubber with stamped steel spine as original.

- JSS-089 1967-69 Convertible..... 39.99 pr.



MHB-679

Header Bow

OE style reproduction of the often damaged or rusted header bow which attaches to the top of the frame rails.

- MHB-679 1967-69 Convertible.....199.95 ea.
- Ships Oversize.*

Convertible Top Frame

This high quality reproduction steel convertible top frame is complete with fully reinforced hinge mechanisms along with everything you need to replace this rusted out frame. Designed for power top models. Manual top models will require major modification.

MCT-1000 1967-69 Convertible..... 999.95 ea.

Ships Truck Freight to a commercial address.



MBS-67K

Convertible Top Frame Mounting Hardware

All new correctly plated hardware for mounting the top pivot bracket to the body, adjustment arms to pivot bracket and top spring on manual tops and cylinders on power top models.

MBS-67K 1967-69 All 49.99 kit



MCT-1000



MTL-479



MHL-701K

Convertible Top Latch Assembly

Quality reproductions of the top latch assembly complete with hook and ready to install.

MTL-479 1967-69 Assembly..... 99.95 pr.

MHL-701K Hooks & Knuckles Only.....36.95 kit



GW-458

GT-159

1967-68 Top Switch

Correct switch and housing for operation of power top.

GT-159 1967-68 Switch..... 32.95 ea.

GW-458 1967-68 Bracket w/ Clips..... 17.99 ea.



GT-69

MTB-17



GW-082

1969 Switch & Bezel

Correct switch and die cast bezel.

GT-69 1969 Switch 59.95 ea.

MTB-17 1969 Bezel..... 44.99 ea.

GW-082 1969 Bracket w/ Clips 17.99 ea.



GRW-016

Power Top Circuit Breaker

Original GM breaker.

GRW-016 1967-69 17.99 ea.



RPS-1000A

Convertible B Pillar Support Brackets

OE style replacement B pillar supports for your convertible.

RPS-1000A 1967-69 Convertible..... 89.95 pr.



MRS-380

Convertible Top Frame Rubber Stoppers

Used to eliminate top frame pieces rubbing together when folding into the well.

MRS-380 1967-69 Convertible..... 9.99 pr.



MCT-1

Header Bow End Clip

Correct clip for outside of top.

MCT-1 1967-69 5.99 pr.



MSB-744

Convertible Header Bow Stop Bumpers

Correct high density stop bumpers.

MSB-744 1967-69 Convertible..... 11.99 pr.



MWL-67

Convertible Well Liner

Correct vinyl material for "top down" well area.

MWL-67 1967-69 Convertible..... 72.99 ea.



MCB-60

Convertible Floor Pan Cross Brace

OE style reproduction stamped steel transmission tunnel brace for under floor pan.

MCB-60 1967-69 89.95 ea.
 MCB-BOLT Bolt Kit 6pc..... 5.95 kit

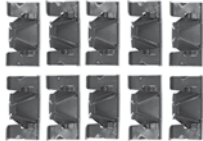

LMC-3640

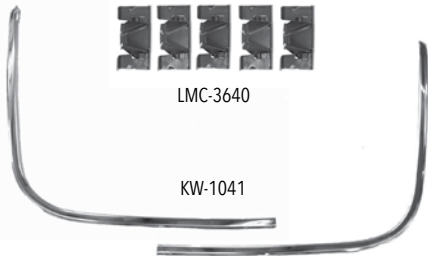

KW-1041

Convertible Well Molding

OE style reproduction rear body pinch weld moldings in polished stainless steel as original.

KW-1041 1967-69 Convertible..... 139.95 set
 LMC-3640 Attaching Clip Set..... 39.95 set
No Volume Discount. Ships Oversize.

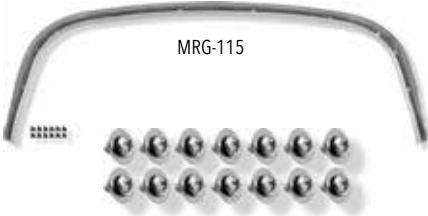

MRG-115



BRG-723

Well Rain Gutter

Correct plastic gutter that prevents water from entering car.

MRG-115 1967-69 Convertible..... 189.99 ea.
 BRG-723 Installation Screws 14pc..... 12.99 kit



MTS-67



BTS-62

Convertible Tack Strip

This is an OE style reproduction of the original metal tack strip bar with plastic insert, which attaches the top to the rear trunk well.

MTS-67 1967-69 Convertible 3pc..... 99.95 ea.
 BTS-62 Installation Bolt Kit 17pc..... 14.99 kit



MHD-169

Manual Hold Down Latch

Correct latches used to hold down the top on manual top models.

MHD-169 1967-69 Manual Top 23.99 pr.



MHD-225

Manual Top Latch Hardware

Reproductions of the original hardware, for manual convertible tops only. Correct industrial chrome plated hardware for mounting the manual top hold down latches. One set will mount both latches.

MHD-225 1967-69 (4 pc)..... 19.99 kit



KDW-4578

Convertible Wedge Kit

This kit includes shims for doors, brass and teflon wedges and all mounting hardware.

KDW-4578 1967-69 Convertible..... 44.95 set



MTM-101

Convertible Top Motors

New OEM motors.

MTM-101 1967-69 Convertible..... 269.99 ea.
 MMB-3 Mounting Grommet..... 5.95 ea.

No Volume Discount.



MMB-3



MTH-33

Convertible Top Hose

Correct white hose with original brass fittings. Buy the pair and save!

MTH-33K 1967-69 Convertible..... 95.95 pr.
No Volume Discount.



MTC-12

Convertible Top Cylinder

Correct replacement cylinder made in USA.

MTC-12 1967-69 Convertible..... 129.99 ea.
No Volume Discount.



MTH-CLIP

Convertible Top Hose Clip

This is used in the trunk area to hold the convertible top hoses in place. Painted the correct red primer color with #4 in circle, spring steel.

MTH-CLIP 1967-69 6.95 ea.



RKP-245R

Rear Inner Covers

Correct reproduction stamped steel inner quarter window access panel for convertibles. Includes mounting tab to correctly install rear convertible side well covers.

RKP-245L 1967-69 LH..... 49.99 ea.
 RKP-245R 1967-69 RH 49.99 ea.

Trunk Mats

These new die stamped heavy duty vinyl trunk mats are the perfect finishing touch to your trunk! Constructed of heavy duty vinyl, this mat will last for years to come!



PEM-222RA	1967-68 Aqua/Black	70.99 ea.
PEM-222R	1967-68 Gray/Black	70.99 ea.
PEM-223R	1969 Aqua	70.99 ea.
PEM-230R	1970-72 Aqua	73.99 ea.
PEM-73V	1973-77 Herringbone	66.99 ea.
PEM-81V	1978-81 Herringbone	66.99 ea.

Spare Tire Cover

These spare tire covers are constructed of the same durable material as our trunk mats, so they make an excellent finishing touch!



PEM-161A	Aqua Houndstooth 14"	49.99 ea.
PEM-162	Aqua Houndstooth 15"	49.99 ea.
PEM-163A	Herringbone 14"	49.99 ea.
PEM-163B	Herringbone 15"	49.99 ea.

Trunk Lid Spring with Sleeve

Correct right side torsion rod and heavy spring used on all models with rear spoiler. Includes heavy molded rubber sleeve. Can also be used on models without rear deck lid spoiler.

RLS-693	1967-69	29.99 ea.
---------	---------	-----------



Spare Tire Anchor Plate & Hold Down

Correct spare tire anchor plate and spare tire hold down.

P-2000	1967-74 Anchor Plate	9.95 ea.
BHE-1970	1967-81 All Hold Down	9.95 set

GWC-SPK



Trunk Wire Clips

This is a pair of correct GM wiring clips which are used to hold the wiring for the power trunk or trunk light wires to the trunk hinge, hold the speaker wires to the package tray or hold the defroster blower motor wire.

GWC-SPK	All	13.95 pr.
---------	-----	-----------

RDP-100



Trunk Floor Drain Plug

Correct stamped plug for trunk floor.

RDP-100	1967-73 All	3.95 ea.
---------	-------------	----------

PLB-141



PLB-175

Jack Load Base

Correct cradle for lifting car which inserts into bumper jack.

PLB-141	1967 All	15.99 ea.
PLB-142	1968 All	15.99 ea.
PLB-175	1969 All	19.99 ea.
PLB-7073	1970-73	21.95 ea.

MBJ-67F



Bumper Jacks

OE style reproduction of this often missing jack. This kit comes complete with jack, base and load base for bumper.

MBJ-67F	1967 All	127.75 kit
MBJ-68F	1968 All	127.75 kit
MBJ-69F	1969 All	131.35 kit
MBJ-703F	1970-73 All	133.11 kit

Note: These jacks are for display purposes only and are not intended for use.

PLW-KIT



Lug Nut Wrench & Sleeve

Correct GM lug wrench, rubber sleeve for retaining it to the jack.

PLW-3	1964-72 Wrench	14.99 ea.
PLS	1964-72 Sleeve	9.95 ea.
PLW-KIT*	Complete Kit	27.91 kit

**Includes sleeve, wrench and hold down.*

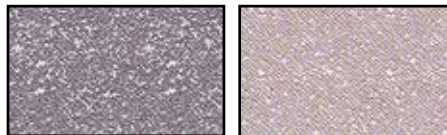

Trunk Spatter Paint

Correct OEM aerosol spray to detail your trunk floor.

DUP-DM102	Black/Gray Spatter	8.99 ea.
DUP-DM100	Gray/White Spatter	8.99 ea.
DUP-DM109	Black/Aqua Spatter	8.99 ea.
DUP-DAL1695	Clear Coat	9.99 ea.



Custom Trunk Panel Kit

This pre-cut custom trunk panel set is easy to clean up your trunk. Each kit includes pre-cut hardboard panels to cover the floor, trunk divider area and the sides of the trunk saving you hours of hand trimming. Add your choice of finishing material such as carpet (not included) and you will have a clean modern trunk to set your muscle car apart from the crowd!

CTPM-317-6	1967-69	194.95 kit
------------	---------	------------

Ships Oversize. Not eligible for free shipping.



Weatherstrip Gutter

New three piece trunk weatherstrip gutter which is required when replacing your quarters.

RTG-67F	1967-69 3pc	49.95 set
RTG-70F	1970-81 2pc	66.99 pr.

1970-81 Trunk Hinge Torque Rod

RLS-539

Reproduction trunk hinge torque rod manufactured as original from precision bent steel. Designed to hold the trunk lid up when open.

RLS-539	1970-81 LH	24.99 ea.
RLS-538	1970-81 RH w/o Spoiler	24.99 ea.
RLS-540	1970-81 RH w/ Spoiler	24.99 ea.

TLR-458



Trunk Lock Rods

Correct rod/shaft that connects the cylinder to the lock assembly.

TLR-458	1967-77 All	3.95 ea.
---------	-------------	----------

Trunk Lamp Harness Assembly

28175	1967-69 Convertible	32.95 ea.
28180	1967-69 Coupe	32.99 ea.
28185	1970-81 All	32.99 ea.

All include extension

Trunk Lamp Extension Harness

28195	1967-69 Convertible	12.99 ea.
28210	1967-69 Coupe	11.99 ea.
15225	1970 All	13.99 ea.
14535	1971-77 All	18.99 ea.



RTC-1067ZA



RTL-1019

Trunk Lid Latch & Lid Catch

OE style reproduction trunk latching device and lid catch.

RTL-1019	1967-69 Lid Latch	29.95 ea.
RTC-1067ZA	1967-69 Lid Catch	18.95 ea.
RTL-7081	1970-81 Lid Latch	29.95 ea.
TLB-716	All Bolts (5pc)	8.95 set

JSS-203



Trunk Weatherstrip

Correct molded trunk weatherstrip.

JSS-203	1967-81 All	14.95 ea.
---------	-------------	-----------

LTB-90



Door/Trunk Lock Bracket

Correct bracket for retaining lock cylinder in place.

LTB-90	1967-81 All	2.99 ea.
--------	-------------	----------

LTR-1



Trunk Lock Retainer

OE style reproduction of this hard to find bracket.

LTR-1	1967-68 All	18.99 ea.
LTR-3	1969 All	18.99 ea.



LLB-628



LLG-946

1970-73 Trunk Lock Bezel & Gasket

OE style reproduction chrome lock bezel and gasket.

LLB-628	1970-73 Bezel	32.99 ea.
LLG-946	1970-73 Gasket	14.99 ea.



Complete Rally Wheel Kits

Why sift through the junk yard for a used set of wheels or try to repair your originals? Ground Up offers complete wheel kits including a complete set of wheels, caps, trim rings and a set of lug nuts! These kits include everything you need to get your muscle car rolling in style.

with Chevrolet Motor Division Flat Caps

NRK-146	14 x 6578.47 kit
NRK-146DB	14 x 6 w/ Factory Disc578.47 kit
NRK-147	14 x 7597.33 kit
NRK-157	15 x 7596.01 kit
NRK-158	15 x 8538.88 kit
NRK-157-8K	15 x 7 Front, 15 x 8 Rear589.94 kit

with Chevrolet Disc Brakes Flat Caps

NRK-246	14 x 6578.47 kit
NRK-246DB	14 x 6 w/ Factory Disc578.47 kit
NRK-247	14 x 7597.33 kit
NRK-257	15 x 7596.01 kit
NRK-258	15 x 8538.88 kit
NRK-257-8K	15 x 7 Front, 15 x 8 Rear589.94 kit

with Turbine Style Raised Caps (1968+ Style)

NRK-346	14 x 6800.63 kit
NRK-346DB	14 x 6 w/ Factory Disc800.63 kit
NRK-347	14 x 7819.50 kit
NRK-357	15 x 7842.00 kit
NRK-358	15 x 8761.04 kit
NRK-357-8K	15 x 7 Front, 15 x 8 Rear824.02 kit



BUY'N SAVE WITH KITS

BUY'N SAVE WITH KITS



Complete SS Wheel Kits

This kit includes a complete set of SS wheels, center caps with retainers, trim rings and a set of lug nuts to get your Super Sport rolling!

NVW-70K	14 x 7688.51 kit
NVW-71K15	15 x 7748.01 kit

No Volume Discount.

All wheel kits ship in multiple Oversize Boxes.

KEEP A LOOK OUT FOR THESE LOGOS BELOW THROUGHOUT THE CATALOG FOR BIG SAVINGS AND DISCOUNTS ON KITS!

BUY'N SAVE WITH KITS



NVW-4837-MAG-KIT4

Retro Magnum Alloy SS Wheels

Constructed of aluminum these brand new retro 15 x 7 Super Sport wheels will give your muscle car a more modern look while keeping the old school styling! These awesome new wheels are black powdercoated on the inside and feature machined lips.

NVW-4837-MAG-KIT4	15 x 7 Kit 572.93 kit
NVW-4837-MAG	15 x 7 Spare 139.95 ea.

Ships Oversize. Not eligible for free shipping. No Volume Discount.



NCE-8984

Rally Wheels

Our rally wheels come correctly powdercoated in Argent Silver assuring you not only a great appearance but quality as well.

NCE-8984	14 x 6, 4" Backspace 99.95 ea.
NCE-8985	14 x 6 Disc, 4" Backspace* 99.95 ea.
NCE-0530	14 x 7, 4-1/4" Backspace 99.95 ea.
NCE-0535	15 x 7, 4-1/4" Backspace 89.95 ea.
NCE-0540	15 x 8, 4-1/4" Backspace 89.95 ea.

*Fits factory disc brakes only. Ships Oversize.



NCE-0530C

Chrome Rally Wheels

This reproduction Camaro Rally Wheel is made in the USA and comes in high quality chrome plated steel for a custom look. This Camaro wheel is ready to install right out of the box.

NCE-8984C	14 x 6, 4" Backspace 149.95 ea.
NCE-0530C	14 x 7, 4-1/8" Backspace 149.95 ea.
NCE-0535C	15 x 7, 4-1/4" Backspace 139.95 ea.
NCE-0540C	15 x 8, 4-1/2" Backspace 129.95 ea.

Fits cars with 5 lug axles. These wheels do not include center caps or lug nuts. Ships Oversize.



NVW-4832

Super Sport Wheels

OE style reproduction SS wheel which comes correctly painted and ready to install.

NVW-4832	14 x 7, 4 1/4" Backspace 144.95 ea.
NVW-4837	15 x 7, 4 1/4" Backspace 149.95 ea.
NVW-4838	14 x 7, 4 1/4" Backspace 149.95 ea.

Ships Oversize.



NWW-4831C

Chrome Super Sport Wheels

This reproduction Camaro Super Sport Wheel is made in the USA and comes in high quality chrome plated steel for a custom look. This Camaro wheel is ready to install right out of the box.

- NWW-4831C 14 x 6, 4" Backspace 184.95 ea.
- NWW-4832C 14 x 7, 4 1/8" Backspace 149.99 ea.
- NWW-4837C 15 x 7, 4 1/4" Backspace 194.95 ea.
- NWW-4838C 15 x 8, 4 1/2" Backspace 209.95 ea.

These wheels do not include center caps or lug nuts.
Ships Oversize.



NSW-146

Steel COPO Wheels

This is a brand new factory style steel Camaro wheel which was usually standard equipment on six cylinder cars, Special High Performance Cars and COPO cars. These steel wheels were usually discarded over the years in favor of Rally Wheels or Super Sport Wheels and are tough to find. This wheel is perfect for your bone stock restoration, COPO recreation or sleeper.

- NSW-146 14 x 6, 4 1/2" Backspace 99.95 ea.
 - NSW-147 14 x 7, 4 3/4" Backspace 99.95 ea.
 - NSW-157 15 x 7, 4 3/4" Backspace 99.95 ea.
- Only fits 1967-69 Camaro



NCW-147

1980-81 Aluminum Wheels

Reproduction of the aluminum wheel for 1980-81 Camaro models. Features the standard GM 5 on 4.75 bolt pattern. 4.25 backspacing.

- NCW-147 14 x 7 199.99 ea.
- NCW-157 15 x 7 199.99 ea.



NW1785SLV

17 Inch N90 Wheels

Add a modern stance to your muscle car while keeping with its classic styling! This is a 17 inch version of the N90 wheel that original came on 1980-1981 Z/28 and 1986-1988 Monte Carlo models. Accepts original style center caps and lug nuts.

- NW1784SLV 17 x 8, 4.25" B/S 219.95 ea.
- NW1785SLV 17 x 8, 5" B/S 219.95 ea.



CMW178BLK

17 Inch SS Mag Wheels

Add a modern stance to your muscle car while keeping with its classic styling! This is a 17 inch version of the Super Sport Wheel that originally came on various GM models. Accepts original style center caps and lug nuts.

- CMW178BLK 17 x 8, 4.5" B/S 239.99 ea.
- CMW179BLK 17 x 9, 5.125" B/S 252.99 ea.
- MWR2 Center Cap Retainers 20.95 set
- C5782 Screws (10pc.) 4.95 kit

Note: If using your existing center caps you will need to use MWR2 center cap retainers and C5782 screws to fit these retainers.



ZW1784GUN

17 Inch 5 Spoke Rally Wheels

Add a modern stance to your muscle car while keeping with its classic styling! This is a 17 inch version of the 5 spoke Z/28 wheel that originally came on 1970-1981 Camaro. Accepts original style center caps and lug nuts.

- ZW1784GUN 17 x 8, Gunmetal, 4.25" B/S 239.95 ea.
 - ZW179GUN 17 x 9, Gunmetal, 5" B/S 239.95 ea.
- IAS-F69D



NJT-716

NJT-665



Lug Nuts

Correct style lug nuts for your wheels.

- NJT-716 Acorn 7/16 0.95 ea.
- NJT-665 Stainless SS 1.95 ea.
- NJT-665KIT SS 20pc 35.10 kit
- NJT-135 All w/ Aluminum Rims 3.99 ea.

NVV-4837-MAG-17x8

Retro Magnum Alloy SS Wheels

Constructed of aluminum these brand new retro 17" Super Sport wheels will give your muscle car a more modern look while keeping the old school styling! These awesome new wheels are black powdercoated on the inside and feature machined lips.

- NVV-MAG-17X7 17 x 7 199.95 ea.
- NVV-MAG-17X7-CHROME 17 x 7 209.95 ea.
- NVV-MAG-17X8 17 x 8 209.95 ea.
- NVV-MAG-17X8-CHROME 17 x 8 216.95 ea.

Ships Oversize. Not eligible for free shipping. No Volume Discount. 17 Inch rims come with a blank center cap.



NZW-157

1970-81 5 Spoke Rim

Exact reproduction 5 spoke steel wheel originally installed on Z/28 models.

- NZW-157 1970-81 199.99 ea.



NJ-1530

Rally Wheel Center Cap

Correct turbine style raised style center cap with "Chevrolet Motor Division".

- NJ-1530 Motor Division Cap 1968 92.95 ea.



Rally Wheel Cap Kits

Ground up offers complete rally wheel center cap kits which include the center caps, bases, and hardware for all 4 wheels. Chrome plated metal center cap with a polished stainless-steel base.

- NJ-150K Chevrolet Motor Division 124.95 kit
- NJ-151K Chevrolet Disc Brakes 124.95 kit
- NJ-152K Motor Division Raised 334.62 kit



1978-81 Rally Wheel Bezel

This is the correct chrome bezel that inserts into the slots on your ZJ7 6 slot rally wheels.

- NWB-781 1978-81 w/ Rally Wheel 12.99 ea.
- 6 required per wheel.

BUY 'N SAVE
WITH KITS



Trim Ring Sets

OE style reproduction trim ring kits at an affordable price.

NTR-146	14 x 6 Rally	98.99 kit
NTR-147	14 x 7 Rally	119.95 kit
NTR-157	15 x 7 Rally	95.00 kit
NTR-157-B	15 x 7 Rally With Bowtie	115.99 kit
NTR-158	15 x 8 Rally	95.00 kit
NTR-158-B	15 x 8 Rally With Bowtie	115.99 kit

SS Trim Ring Sets

OE style reproduction trim rings packaged in convenient sets for your Super Sport.

NTW-1090	1969 14 x 7.....	99.95 kit
NTW-1095	1969 15 x 7.....	149.95 kit
NTR-70Z	1970-81 15 x 7*	139.95 kit

*Gray 5 Spoke Style

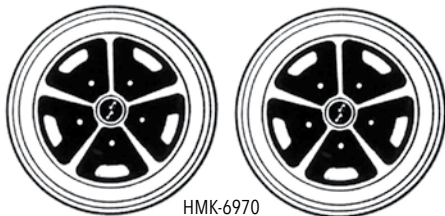

SS Wheel Restoration Supplies

Ground Up offers everything you need to restore your original Super Sport Wheels. Order our 4 piece paint mask kit along with Argent Silver and SS Insert gray paint for a complete job.

HMK-6970	Paint Mask*.....	27.95 kit
DUP-HWP101	Argent Silver Paint (11oz. can).....	7.99 ea.
HDP-1214	Insert Gray Paint (11oz. can).....	7.95 ea.

*Masks 4 Rims

OEM Style SS Center Cap Kit

These center caps are reserved for the true purist because they feature a deep indented SS center cap like factory. These caps are a little pricier but are the obvious choice when going for a totally stock restoration.

NSS-70K	1969-70 Complete.....	99.95 kit
---------	-----------------------	-----------

Center Cap Kit

This complete set includes (4) nice reproduction center caps with retainers (where applicable) for your SS wheels.

NJT-671K	1969-70 8pc	73.01 kit
NJT-63K	1971-72 4pc	71.82 kit

Yenko Center Cap Kit SS Wheels

This is a complete Yenko tribute wheel center cap kit which includes (4) reproduction SS center caps with Yenko decals and (4) retainers. These caps fit 1969-1790 Super Sport and Olds SS1 wheels.

NJT-YENKO	1969-70 Complete.....	139.95 kit
-----------	-----------------------	------------

NCE-671 Retainer..... 5.95 ea.

Super Sport Center Caps

OE style reproduction retainers and caps to freshen up your Super Sport Wheels.

NCE-6770

NCE-6770	SS Cap	15.99 ea.
----------	--------------	-----------

NCX-396	SS396 Cap.....	16.95 ea.
NCX-454	SS454 Cap	16.95 ea.

NCE-700

NCE-700	SS Decal Only.....	5.95 ea.
---------	--------------------	----------

NCD-396	SS396 Decal Only	7.95 ea.
NCD-454	SS454 Decal Only	7.95 ea.

NCE-312	NCD-313	NCC-358
---------	---------	---------

NCC-632	NCC-8587Z-G	NCC-8587Z-S
---------	-------------	-------------

1978-87 Center Caps & Emblems

NCE-312	1978 YJ8, 1979 N90 Center Cap..	21.99 ea.
NCD-313	1978 YJ8, 1979 N90 Emblem.....	12.99 ea.
NCC-358	1980 N90 Emblem Blk Blk	21.99 ea.
NCC-632	1980 N90 Emblem Blk Red	21.99 ea.
NCC-8587Z-G	1985-87 Iroc Z Gold	19.99 ea.
NCC-8587Z-S	1985-87 Iroc Z Silver	19.99 ea.



NCC-688 NCC-872 NCE-9479

NCC-688	1977-78 Z/28.....	27.99 ea.
NCC-872	1979-81 Z/28.....	39.99 ea.
NCE-9479	1971-72 SS.....	19.95 ea.



NCD-106 NYC-105

1969 Yenko Wheel Ornament Decal

Correct pressure sensitive decal for use on 1969 Yenko models equipped with Torque Thrust wheels.

NCD-106	1969 Yenko.....	9.99 ea.
---------	-----------------	----------

1967-68 Yenko Rally II Wheel Cap

OE style reproduction chrome wheel center cap for use with Yenko models equipped with Pontiac Rally II wheels.

NYC-105	1967-68.....	39.99 ea.
---------	--------------	-----------



NDD-210 NDD-220 NDD-230

Dog Dish Hubcaps

These are OE style reproduction hub cap sets that were commonly found on many high performance cars. They feature excellent stamping, paint and chrome which ensures not only aggressive looks, but excellent quality.

NDD-210	1966 All	384.99 kit
NDD-220	1967 All	384.99 kit
NDD-230	1968-70 All	384.99 kit
NDD-200	1962 All	428.99 kit

These will only fit stock steel wheels. They will not fit Rally Wheels or SS Wheels.



NJ-14

1967 14" Wheel Cover

OE style reproduction stamped from high quality stainless steel and highly polished.

NJ-14	1967	59.99 ea.
-------	------------	-----------



ER-7014RL ER-7014RW

Factory Style Radial Tires

If you're going for an authentic Camaro restoration, be sure that you don't overlook the tires! Previously, this meant sacrificing modern ride quality and handling characteristics for an authentic appearance, but now you can have the best of both worlds with these modern radial tires that have a period correct appearance. This factory style Firestone Wide Oval tire is an almost exact replica of the original, engineered from the ground up to provide excellent ride quality, tread life and safety, while retaining the correct tread pattern and raised white lettering.

Firestone Wide Oval

ER-7014RW	ER70-14	236.95 ea.
FR-7014RW	FR70-14	269.99 ea.
GR-7014RW	GR70-14.....	321.99 ea.
FR-7015RW	FR70-15	302.99 ea.
FR-6015RW	FR60-15	363.99 ea.
GR-7015RW	GR70-15.....	321.99 ea.

Firestone Redline

ER-7014RL	ER70-14	236.95 ea.
FR-7014RL	FR70-14	269.99 ea.
GR-7014RL	GR70-14.....	321.99 ea.
FR-7015RL	FR70-15	302.99 ea.
GR-7015RL	GR70-15.....	321.99 ea.



Factory Style Tires

If authenticity is your goal, then look no further. All of our tires feature the same tread patterns and raised white lettering as the originals.

Goodyear Polyglas

GE-7014	E70 x 14	245.99 ea.
GF-7014	F70 x 14	259.99 ea.
GF-7114	F70 x 14*	259.99 ea.
GF-6015	F60 x 15	299.99 ea.
GG-7014	G70 x 14	269.99 ea.
GG-6015	G60 x 15	324.99 ea.

**1969 - early 1970 w/o tire size in RWL*

No Volume Discount. Ships Oversize.

Firestone Wide Oval

FE-7014	E70 x 14	251.99 ea.
FF-7014	F70 x 14	256.99 ea.
FG-7014	G70 x 14	274.99 ea.
FF-7015	F70 x 15	289.99 ea.
FG-7015	G70 x 15	306.99 ea.
FF-6015	F60 x 15	346.99 ea.

Firestone Redline

RF-7014	F70 x 14	256.99 ea.
RG-7014	G70 x 14	274.99 ea.
RF-7015	F70 x 15	289.99 ea.
RG-7015	G70 x 15	442.99 ea.

American Racing Wheel Kits

American Racing is the brand that started it all with their revolutionary Torq Thrust wheels. For the first time Ground Up® is offering these wheels in easy to order sets of 4 wheels.

BS = BACKSPACE



ARKIT-TT2G-147



ARKIT-RDB-177

Classic Torq Thrust II One Piece Mag Grey Machined Lip

ARKIT-TT2G-146	14x6 3.42"BS.....	448.00 kit
ARKIT-TT2G-147	14x7 4.0"BS.....	460.00 kit
ARKIT-TT2G-157	15x7 3.76"BS.....	500.00 kit
ARKIT-TT2G-158	15x8 4.5"BS.....	512.00 kit
ARKIT-TT2G-1578	15x7 Front 15x8 Rear.....	506.00 kit

Torq Thrust II One Piece Chrome

ARKIT-TT2C-147	14x7 4.0"BS.....	892.00 kit
ARKIT-TT2C-157	15x7 3.76"BS.....	956.00 kit
ARKIT-TT2C-158	15x8 4.5"BS.....	984.00 kit
ARKIT-TT2C-1578	15x7 Front 15x8 Rear.....	970.00 kit
ARKIT-TT2C-177	17x7 4.0"BS.....	1160.00 kit
ARKIT-TT2C-178	17x8 4.81"BS.....	1176.00 kit
ARKIT-TT2C-1778	17x7 Front 17x8 Rear.....	1168.00 kit

Torq Thrust II One Piece PVD Chrome

ARKIT-TT2CPVD-157	15x7 3.76"BS.....	856.00 kit
ARKIT-TT2CPVD-158	15x8 4.5"BS.....	788.00 kit
ARKIT-TT2CPVD-1578	15x7 Front 15x8 Rear.....	822.00 kit
ARKIT-TT2CPVD-177	17x7 4.0"BS.....	956.00 kit
ARKIT-TT2CPVD-178	17x8 4.81"BS.....	1068.00 kit
ARKIT-TT2CPVD-1778	17x7 Front 17x8 Rear.....	1012.00 kit

Torq Thrust II One Piece Polished

ARKIT-TT2POL-157	15x7 3.76"BS.....	624.00 kit
ARKIT-TT2POL-158	15x8 4.5"BS.....	636.00 kit
ARKIT-TT2POL-1578	15x7 Front 15x8 Rear.....	630.00 kit
ARKIT-TT2POL-177	17x7 4.0"BS.....	1416.00 kit

Torq Thrust D Chrome

ARKIT-TTDC-157	15x7 3.76"BS.....	916.00 kit
ARKIT-TTDC-158	15x8 4.5"BS.....	952.00 kit
ARKIT-TTDC-1578	15x7 Front 15x8 Rear	934.00 kit

Torq Thrust D Black w/ Machined Lip

ARKIT-TTDB-157	15x7 3.76"BS	552.00 kit
ARKIT-TTDB-158	15x8 4.5"BS.....	596.00 kit
ARKIT-TTDB-1578	15x7 Front 15x8 Rear	574.00 kit

Torq Thrust M Anthracite w/ Machined Lip

ARKIT-TTMMG-177	17x7 4.0"BS.....	672.00 kit
ARKIT-TTMMG-178	17x8 4.5"BS.....	744.00 kit
ARKIT-TTMMG-1778	17x7 Front 17x8 Rear	708.00 kit



BEST SELLER! \$AVE BIG!

Front Power Disc Brake Conversion Kits

Upgrade your Camaro today with the most complete front disc brake kit on the market. Includes all OEM parts and is available with multiple upgrades. Increase stopping power and give your car that factory stock disc brake appearance. Works with 15" wheels or larger. Includes:

- 11" rotors
- Forged spindles
- Bearings & Seals
- Loaded calipers
- Caliper brackets
- Backing plates
- Flex Hoses & Clips
- Master cylinder
- Power Booster (9" or 11" Gold)
- Combination valve & bracket
- All hardware

FM-1790FS-UP	1967-69 Camaro with 11" Booster.....	571.08 kit
FM-1790FS9-UP	1967-69 Camaro with 9" Booster.....	571.08 kit
FM-1790DSF	1967-69 Camaro 2" Drop Spindle - 11" Booster.....	603.99 kit
FM-1790DSF9	1967-69 Camaro 2" Drop Spindle - 9" Booster.....	603.99 kit



SHOW N'GO UPGRADE

This package adds drilled and slotted rotors and red or black powdercoated calipers.

FM-1790FS-UP-S	1967-69 D/B Kit with Show N Go Black.....	649.76 kit
FM-1790FS-UP-Z	1967-69 D/B Kit with Show N Go Red.....	649.76 kit
FM-1790DSFS	1967-69 2" Drop Kit 11" w/ Show N Go Black.....	711.99 kit
FM-1790DSFZ	1967-69 2" Drop Kit 11" w/ Show N Go Red.....	711.99 kit

1970-81 Front disc upgrade to drilled and slotted rotors with powdercoated calipers.

This kit contains the rotors and calipers only.

FMC-7077B-UP	1970-77 Black Calipers.....	298.78 kit
FMC-7077R-UP	1970-77 Red Calipers.....	298.78 kit
FMC-7078B-UP	1978 Black Calipers.....	297.88 kit
FMC-7078R-UP	1978 Red Calipers.....	297.88 kit
FMC-7981B-UP	1979-81 Black Calipers.....	297.88 kit
FMC-7981R-UP	1979-81 Red Calipers.....	297.88 kit



BEST OF SHOW UPGRADE

Adds drilled & slotted rotors, 8" chrome master, booster, pro-valve assembly and powdercoated calipers.

FM-1790FS-UP-SX	1967-69 D/B Kit w/ Best of Show Black.....	724.46 kit
FM-1790FS-UP-ZX	1967-69 D/B Kit w/ Best of Show Red.....	724.46 kit
FM-1790DSFX	1967-69 2" Drop Kit w/ Best of Show Black.....	783.99 kit
FM-1790DZFX	1967-69 2" Drop Kit w/ Best of Show Red.....	783.99 kit

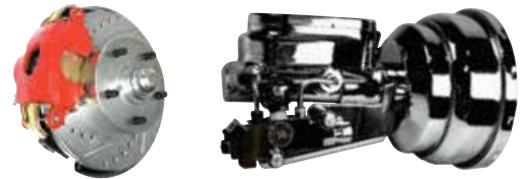

SHOW STOPPER UPGRADE

Adds drilled & slotted rotors and a chrome master, booster, pro-valve assembly

FM-1790FS-UP-X	1967-69 D/B Kit w/ Show Stopper Chrome.....	679.38 kit
----------------	---	------------



DISC BRAKE CONVERSION LINE KITS – NO BRAINER

Simplify your installation with all the brake lines and clips you will need.

Includes: • Front line kit, • Front to rear line, • Rear axle line set, • Rear flex hose, • Clip set

	Original	Stainless
F67DCKIT_ * _ * _ *	1967 Camaro.....	114.99 kit.....
F68DCKIT_ * _ * _ *	1968 Camaro.....	119.99 kit.....
F69DCKIT_ * _ * _ *	1969 Camaro.....	157.99 kit.....
F69DCKIT_ * _ * _ *	1969 Camaro.....	99.99 kit.....
FCS67DC	1967-69 All Line Clip Kit.....	137.99 kit.....
		18.99 ea.

Add to these to the part #'s* above for the following: *M - Manual brakes-No Power booster used
*4 - for 4 wheel disc brakes *SS - for stainless steel lines

KEEP YOUR FACTORY 14" WHEELS – POWER FRONT DISC BRAKE KITS

Half the install time & no alignment needed- Bolts directly to stock drum spindles, fits any 14" wheel, uses a proprietary rotor. Includes booster, master, combo valve, rotors, calipers, brackets and hardware.

	MSRP	KIT
AFXDC14-11	1967-69 Camaro 11" Power Booster.....	575.99.....
AFXDC14-9	1967-69 Camaro 9" Power Booster.....	517.99 kit.....

THE
RIGHT
Stuff

AFXSD42CZ



Four Wheel Power Disc Brake Conversion Kits

Upgrade your classic to the ultimate in stopping power. Our 4 wheel kits are the most complete kits in the industry at rock bottom prices. Upgrade packages available- see ledger below. Add our No Brainer- Disc Brake line kit for a care-free installation.

Stock Height Non-Staggered Rear Shocks

AFXDC42C	1967-69 Camaro 11"PB	895.99 kit
AFXDC42CS	1967-69 Camaro 11"PB, DS, BPC	1102.99 kit
AFXDC42CZ	1967-69 Camaro 11"PB, DS, RPC	1102.99 kit
AFXDC42CX	1967-69 Camaro 8" Chrome PB	990.99 kit
AFXDC42CSX	1967-69 Camaro 8" Chrome PB, DS, BPC	1170.99 kit
AFXDC42CZX	1967-69 Camaro Nova 8" Chrome PB, DS, RPC	1170.99 kit

Stock Height Staggered Rear Shocks

AFXDC45C	1967-69 Camaro 11"PB	895.99 kit
AFXDC45CS	1967-69 Camaro 11"PB, DS, BPC	1102.99 kit
AFXDC45CZ	1967-69 Camaro 11"PB, DS, RPC	1102.99 kit
AFXDC45CX	1967-69 Camaro 8" Chrome PB	990.99 kit
AFXDC45CSX	1967-69 Camaro 8" Chrome PB, DS, BPC	1170.99 kit
AFXDC45CZX	1967-69 Camaro 8" Chrome PB, DS, RPC	1170.99 kit

2" Dropped Spindle Height Non-Staggered Rear Shocks

AFXDC42D	1967-69 Camaro 11"PB	945.99 kit
AFXDC42DS	1967-69 Camaro 11"PB, DS, BPC	1152.99 kit
AFXDC42DZ	1967-69 Camaro 11"PB, DS, RPC	1152.99 kit
AFXDC42DX	1967-69 Camaro 8" Chrome PB	1039.99 kit
AFXDC42DSX	1967-69 Camaro 8" Chrome PB, DS, BPC	1219.99 kit
AFXDC42DZX	1967-69 Camaro 8" Chrome PB, DS, RPC	1219.99 kit

Staggered Rear Shocks

AFXDC45D	1967-69 Camaro 11"PB	945.99 kit
AFXDC45DS	1967-69 Camaro 11"PB, DS, BPC	1152.99 kit
AFXDC45DZ	1967-69 Camaro 11"PB, DS, RPC	1152.99 kit
AFXDC45DX	1967-69 Camaro 8" Chrome PB	1039.99 kit
AFXDC45DSX	1967-69 Camaro 8" Chrome PB, DS, BPC	1219.99 kit
AFXDC45DZX	1967-69 Camaro 8" Chrome PB, DS, RPC	1219.99 kit

PB- Gold Power Booster, DS- Drilled & Slotted Rotors, BPC-Black Powdercoated Calipers, RPC-Red Powdercoated Calipers CH-Chrome Power Assembly (booster, master, pro-valve) Please call for manual disc brake conversions.

TRSD Signature Series Disc Brake Conversion Kit

Get bold looks and big performance with this new Signature Series disc brake kit from TRSD! These are amazing brakes at a great price! There are several levels to choose from.

Basic Kit Includes:

- 13 inch front drilled/slotted zinc plated rotors
- 12 inch rear drilled/slotted zinc plated rotors (Applies to rear & 4 wheel kit only.)
- 2024-T6 forged aluminum hubs w/ 7/16" and 1/2" studs (to fit multiple applications)
- Twin piston aluminum calipers
- Fully machined caliper brackets
- Ceramic brake pads
- Braided stainless steel hoses
- Integrated parking brake (Applies to rear & 4 wheel kit only.)
- Premium quality hardware.

Complete Manual Kit:

- Everything in the basic kit
- OEM Style Master Cylinder w/ Combination Valve

Complete Manual Kit: (Chrome Upgrade Available) • Everything in the complete manual kit



4 Wheel Kit with 2" Drop (Includes New Drop Spindles) Non-Staggered

AFXWK51DS	1967 Basic Kit	1440.99 kit
AFXSD51DS	1967 Complete Manual Kit	1530.99 kit
AFXSD51DSX	1967 Complete Manual Kit w/ Chrome Upgrade	1597.99 kit
AFXDC51DS	1967 Complete Power Kit	1620.99 kit
AFXDC51DSX	1967 Complete Power Kit w/ Chrome Upgrade	1714.99 kit

4 Wheel Kit with 2" Drop (Includes New Drop Spindles) Staggered

AFXWK55DS	1968-69 Basic Kit	1440.99 kit
AFXSD55DS	1968-69 Complete Manual Kit	1530.99 kit
AFXSD55DSX	1968-69 Complete Manual Kit w/ Chrome Upgrade	1597.99 kit
AFXDC55DS	1968-69 Complete Power Kit	1620.99 kit
AFXDC55DSX	1968-69 Complete Power Kit w/ Chrome Upgrade	1714.99 kit

4 Wheel Kit Stock Height (Reuse Original Spindles) Non-Staggered

AFXWK51CS	1967 Basic Kit	1282.99 kit
AFXSD51CS	1967 Complete Manual Kit	1372.99 kit
AFXSD51CSX	1967 Complete Manual Kit w/ Chrome Upgrade	1440.99 kit
AFXDC51CS	1967 Complete Power Kit	1462.99 kit
AFXDC51CSX	1967 Complete Power Kit w/ Chrome Upgrade	1557.99 kit

4 Wheel Kit Stock Height (Reuse Original Spindles) Staggered

AFXWK55CS	1968-69 Basic Kit	1282.99 kit
AFXSD55CS	1968-69 Complete Manual Kit	1372.99 kit
AFXSD55CSX	1968-69 Complete Manual Kit w/ Chrome Upgrade	1440.99 kit
AFXDC55CS	1968-69 Complete Power Kit	1462.99 kit
AFXDC55CSX	1968-69 Complete Power Kit w/ Chrome Upgrade	1557.99 kit

Front Only Kit with 2" Drop (Includes New Drop Spindles)

AFXWK31DS	1967-69 Basic Kit	877.99 kit
AFXSD31DS	1967-69 Complete Manual Kit	967.99 kit
AFXSD31DSX	1967-69 Complete Manual Kit w/ Chrome Upgrade	1035.99 kit
AFXDC31DS	1967-69 Complete Power Kit	1057.99 kit
AFXDC31DSX	1967-69 Complete Power Kit w/ Chrome Upgrade	1152.99 kit

Front Only Kit Stock Height (Reuse Original Spindles)

AFXWK31CS	1967-69 Basic Kit	715.99 kit
AFXSD31CS	1967-69 Complete Manual Kit	805.99 kit
AFXSD31CSX	1967-69 Complete Manual Kit w/ Chrome Upgrade	873.99 kit
AFXDC31CS	1967-69 Complete Power Kit	895.99 kit
AFXDC31CSX	1967-69 Complete Power Kit w/ Chrome Upgrade	990.99 kit

Rear Only Kit

AFXRD31S	1967 Non-Staggered	625.99 kit
AFXRD35S	1968-69 Staggered	625.99 kit

No Volume Discount. These kits ship in multiple Oversize boxes.

BUY'N SAVE
WITH KITS



Rear Disc Brake Conversion Kit

Complete rear disc brake conversion kit for the ultimate stopping power. This kit includes rotors, loaded calipers, caliper brackets, bracket hardware, flex hoses and rear brake cables. To add drilled and slotted rotors and painted calipers, add the following letters. S for black calipers, Z for red calipers. Ex. AFXRD01S is 1967-69 with black calipers.

		Black	Red
AFXRD01_	1967-69 w/o Staggered	490.99 kit	490.99 kit
AFXRD05_	1967-69 with Staggered	490.99 kit	490.99 kit
AFXRD06_	1970-74 All	490.99 kit	490.99 kit
AFXRD07_	1975-81 All	490.99 kit	490.99 kit
AFXRD78_	1982-92 All	567.99 kit	567.99 kit

5 lug only. No Volume Discount. Ships in multiple Oversize boxes. Ships oversize. No volume discount.

THE RIGHT Stuff



TRSD performance Series Disc Brake Conversions

These all new disc brake conversions from The Right Stuff feature Wilwood 2 piston calipers, street performance brake pads, stainless braided flex hoses, spindles, caliper brackets, dust shields, proportioning valve, brake booster with master cylinder and factory size drilled and slotted rotors making for a super easy installation. These kits fit with most 15" or larger wheels.

4 Wheel Kits

4 Wheel Kits Stock Height Non-Staggered Shocks

AFXSD42CS	1967 Black Calipers Manual	1035.99 kit
AFXSD42CZ	1967 Red Calipers Manual	1035.99 kit
AFXDC42CS	1967 Black Calipers 11" Gold Booster	1102.99 kit
AFXDC42CZ	1967 Red Calipers 11" Gold Booster	1102.99 kit
AFXSD22CSX	1967 Black Calipers Manual Chrome Master	1507.99 kit
AFXSD22CZX	1967 Red Calipers Manual Chrome Master	1507.99 kit
AFXDC22CSX	1967 Black Calipers 8" Chrome Booster	1570.99 kit
AFXDC22CZX	1967 Red Calipers 8" Chrome Booster	1570.99 kit

4 Wheel Kits Stock Height Staggered Shocks

AFXSD25CS	1968-69 Black Calipers Manual	1462.99 kit
AFXSD25CZ	1968-69 Red Calipers Manual	1462.99 kit
AFXDC25CS	1968-69 Black Calipers 11" Gold Booster	1525.99 kit
AFXDC25CZ	1968-69 Red Calipers 11" Gold Booster	1525.99 kit
AFXSD25CSX	1968-69 Black Calipers Manual Chrome Master	1507.99 kit
AFXSD25CZX	1968-69 Red Calipers Manual Chrome Master	1507.99 kit
AFXDC25CSX	1968-69 Black Calipers 8" Chrome Booster	1570.99 kit
AFXDC25CZX	1968-69 Red Calipers 8" Chrome Booster	1570.99 kit

4 Wheel Kits Stock Height Non-Staggered Shocks 2" Drop Spindle

AFXSD22DS	1967 Black Calipers Manual	1498.99 kit
AFXSD22DZ	1967 Red Calipers Manual	1498.99 kit
AFXDC22DS	1967 Black Calipers 11" Gold Booster	1561.99 kit
AFXDC22DZ	1967 Red Calipers 11" Gold Booster	1561.99 kit
AFXSD22DSX	1967 Black Calipers Manual Chrome Master	1543.99 kit
AFXSD22DZX	1967 Red Calipers Manual Chrome Master	1543.99 kit
AFXDC42DSX	1967 Black Calipers 8" Chrome Booster	1219.99 kit
AFXDC42DZX	1967 Red Calipers 8" Chrome Booster	1219.99 kit

4 Wheel Kits Stock Height Staggered Shocks 2" Drop Spindle

AFXSD45DS	1968-69 Black Calipers Manual	1084.99 kit
AFXSD45DZ	1968-69 Red Calipers Manual	1084.99 kit
AFXDC45DS	1968-69 Black Calipers 11" Gold Booster	1152.99 kit
AFXDC45DZ	1968-69 Red Calipers 11" Gold Booster	1152.99 kit
AFXSD25DSX	1968-69 Black Calipers Manual Chrome Master	1543.99 kit
AFXSD25DZX	1968-69 Red Calipers Manual Chrome Master	1543.99 kit
AFXDC45DSX	1968-69 Black Calipers 8" Chrome Booster	1219.99 kit
AFXDC45DZX	1968-69 Red Calipers 8" Chrome Booster	1219.99 kit

Front End Kits Stock Height

AFXDC32S	1967-69 Black Calipers 11" Gold Booster	895.99 kit
AFXDC32Z	1967-69 Red Calipers 11" Gold Booster	895.99 kit
AFXDC32SX	1967-69 Black Calipers 8" Chrome Booster	990.99 kit
AFXDC32ZX	1967-69 Red Calipers 8" Chrome Booster	990.99 kit

Front End Kits 2" Drop Spindle

AFXDC32DS	1967-69 Black Calipers 11" Gold Booster	931.99 kit
AFXDC32DZ	1967-69 Red Calipers 11" Gold Booster	931.99 kit
AFXDC32DSX	1967-69 Black Calipers 8" Chrome Booster	1026.99 kit
AFXDC32DZX	1967-69 Red Calipers 8" Chrome Booster	1026.99 kit

Front End Upgrade Kits

These kits come with drilled and slotted rotors, calipers, spindles and hardware.

AFXWK32S	1967-69 Black Calipers Stock Height	733.99 kit
AFXWK32Z	1967-69 Red Calipers Stock Height	733.99 kit
AFXWK32DS	1967-69 Black Calipers 2" Drop Spindle	774.99 kit
AFXWK32DZ	1967-69 Red Calipers 2" Drop Spindle	774.99 kit

Rear End Kits Non Staggered Shocks

AFXRDM21S	1967 Black Calipers	652.99 kit
AFXRDM21Z	1967 Red Calipers	652.99 kit

Rear End Kits Staggered Shocks

AFXRDM25S	1968-69 Black Calipers	652.99 kit
AFXRDM25Z	1968-69 Red Calipers	652.99 kit
AFXRDM26S	1970-74 Black Calipers	652.99 kit
AFXRDM26Z	1970-74 Red Calipers	652.99 kit
AFXRDM27S	1975-81 Black Calipers	652.99 kit
AFXRDM27Z	1975-81 Red Calipers	652.99 kit
AFXRDM282S	1982-92 Black Calipers	706.99 kit
AFXRDM282Z	1982-92 Red Calipers	706.99 kit

Rear Kits With Front Upgrade Kits

These kits come with a complete rear kit and a front kit with drilled and slotted rotors, loaded calipers and hardware.

Staggered Shocks

F69RDM25S	1968-69 Black Calipers	1215.99 kit
F69RDM25Z	1968-69 Red Calipers	1215.99 kit
F70RDM25S	1970-74 Black Calipers	1215.99 kit
F70RDM25Z	1970-74 Red Calipers	1215.99 kit
F75RDM25S	1975-77 Black Calipers	1215.99 kit
F75RDM25Z	1975-77 Red Calipers	1215.99 kit
F78RDM25S	1978 Black Calipers	1215.99 kit
F78RDM25Z	1978 Red Calipers	1215.99 kit
F79RDM25S	1979-81 Black Calipers	1215.99 kit
F79RDM25Z	1979-81 Red Calipers	1215.99 kit
F82RDM78S	1982-87 Black Calipers	666.99 kit
F82RDM78Z	1982-87 Red Calipers	666.99 kit

These kits ship oversize. No Volume Discount.



BUY'N SAVE WITH KITS

Booster/Master Kits
Replace your old booster and master in one shot and save! These kits are available in many configurations to suit your restoration needs. If you are restoring a car to original specs, the factory style bleeder screws featured in this master cylinder are a must. The booster is available in 9" or 11" configurations and with or without the Delco Moraine stamp. 1967-69 includes round master and 1970-81 includes square master.

BMK-9R	1967-69 with 9" Booster.....	170.83 kit
BMK-11R	1967-69 with 11" Booster	170.83 kit
BMK-9RD	1967-69 with 9" Booster Delco Stamp.....	183.58 kit
BMK-11RD	1967-69 with 11" Booster Delco Stamp	183.58 kit
BMK-9RB	1967-69 with Bleeder Screws with 9" Booster.....	175.08 kit
BMK-11RB	1967-69 with Bleeder Screws with 11" Booster.....	175.08 kit
BMK-9RBD	1967-69 with Bleeder Screws with 9" Booster Delco Stamp.....	187.83 kit
BMK-11RBD	1967-69 with Bleeder Screws with 11" Booster Delco Stamp	176.78 kit
BMK-781	1970-81 11" Booster, Master without Bleeders.....	169.95 kit
BMK-781B	1970-81 11" Booster, Master with Bleeders.....	176.78 kit

No Volume Discount.



Booster, Master, Valve Kits

Included is a brand new Delco style gold booster, a new master cylinder, a correct style proportioning valve with bracket, distribution block with bracket and correct proportioning valve lines. Simply remove your old assembly and install this new one in place with this convenient kit. Available with or without Delco stamp.

OEM Style

BMK-69F	1967-69 w/o Stamp	296.99 kit
BMK-69GM	1967-69 w/ Stamp OEM Style.....	299.95 kit
BMK-69FD	1967-69 w/ Stamp	300.99 kit
BMK-71F	1971-81 w/o Stamp.....	254.99 kit
BMK-71FD	1971-81 w/ Stamp.....	278.99 kit

Chrome

BMK-SHOW9R	1967-69 w/ 9" Power Booster	302.99 kit
BMK-SHOW11R	1967-69 w/ 11" Power Booster	302.99 kit



Slimline Booster / Master / Pro-Valve Kits

These Slimline kits allow you to replace you booster, master cylinder and proportioning valve in one simple step! All kits feature an 8" booster.

SLIM-8G-2	1967-69 Disc/Drum 8" Booster Gold	203.99 kit
SLIM-8G-4	1967-69 Disc/Disc 8" Booster Gold.....	203.99 kit
SLIM-8C-2	1967-69 Disc/Drum 8" Booster Chrome.....	283.99 kit
SLIM-8C-4	1967-69 Disc/Disc 8" Booster Chrome.....	283.99 kit



OEM Style Master Cylinders

Choose from a wide variety of master cylinders to suit your needs. OEM style master cylinders feature cast bodies with caps. Choose a master with bleeders for the ultimate in authenticity.

FMP-1966	1967-81 Dual Drum.....	79.95 ea.
FMP-1967	1967-69 Power Disc.....	74.99 ea.
FMP-069	1967-69 Power Disc w/ Bleeders	79.99 ea.
FMP-1970	1970-81 Power Disc.....	69.95 ea.
FMP-070	1970-81 Power Disc w/ Bleeders	77.99 ea.

Chrome

FMP-1967C	1967-69 Round Disc/Drum 1 1/8" Bore.....	91.99 ea.
FMP-04C	1967-69 Round Disc/Disc 1" Bore	91.99 ea.
FMP-51C	1967-81 Slimline Disc/Drum 1 1/8" Bore.....	100.99 ea.
FMP-56C	1967-81 Slimline Disc/Disc 1" Bore.....	100.99 ea.



Master Cylinder Caps & Gaskets

Correct cadmium plated caps.

Caps

FMC-67D	1967-81 Drum.....	18.95 ea.
FMC-6700	1967-69 Disc.....	16.95 ea.
FMC-6800	1970-81 Disc.....	16.95 ea.

Gaskets

FG-67D	1967-81 Drum.....	6.95 ea.
FG-67B	1967-69 Disc.....	8.95 ea.
FG-695	1970-81 Disc.....	6.95 ea.



Manual Master Cylinder Hardware

Used only on manual brakes to provide support at the firewall for the master cylinder.

FMP-12046	1967-69 Gasket	10.95 ea.
-----------	----------------------	-----------

Correct master cylinder push rod assembly used when converting to manual disc or if the car is manual drum.

FMR-12441	1967-69 Push Rod	56.95 ea.
FLN-12968	1967-69 Clevis Lock Nut.....	2.95 ea.



FBB-6

11" Delco Moraine Booster

Crafted with the same gold cadmium plating as original as well as the Delco Moraine logo stamping for the ultimate in authenticity.

FBB-6 1967-69140.99 ea.



FBB-3

9" Delco Moraine Booster

Crafted with the same gold cadmium plating and Delco Moraine logo as our 11" booster, this 9" booster allows more clearance when running tall valve covers.

FBB-3 1967-69140.99 ea.



FBB-6-UP

Detail

11" Delco Booster w/ Upside Down Logo

Features authentic gold cad plating with correct upside down Delco Moraine logo for the purist.

FBB-6-UP 1967-69170.99 ea.



FPB-7537C

7" Dual Slimline Booster

A good booster when room is tight. Great for big block cars with tall valve covers. Roughly the same assist as a 9" single booster.

FPB-7137 1967-69 Gold.....115.99 ea.
 FPB-7137C 1967-69 Chrome157.99 ea.
 FPB-7137S 1967-69 Stainless.....199.99 ea.



FPB-1102

11" Delco Style Booster

This is a brand new power brake booster crafted with the same gold cadmium plating as original.

FPB-1102 1967-69125.99 ea.



FPB-9022

9" Delco Style Booster

This is a brand new power brake booster crafted with the same gold cadmium plating as original. This 9" booster allows more clearance when running tall valve covers.

FPB-9022 1967-69125.99 ea.

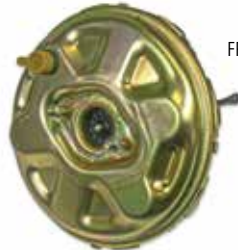

FPB-801

1970-81 11" Booster

Crafted with the same gold cadmium plating as original.

FPB-801 1970-81129.99 ea.



FPB-8531

8" Dual Slimline Booster

Our most powerful Slimline booster. 10-15% more assist than a 9" single. Compact enough to fit most applications.

FPB-8131 1967-69 Gold.....115.99 ea.
 FPB-8131C 1967-69 Chrome157.99 ea.
 FPB-8131S 1967-69 Stainless.....198.99 ea.



FPB-1003C

Chrome Booster

This is a brand new power brake booster crafted with chrome plating to set your car apart from others.

FPB-9021C 1967-69 9"189.99 ea.
 FPB-1003C 1967-69 11"155.99 ea.



FPB-9002

9" Single Slimline Booster

Nice clean looks and performance that won't disappoint. A good choice if you're undecided on which booster to get.

FPB-9102 1967-69 Gold.....115.99 ea.



EVPO1

Electric Vacuum Kit

If you have a big cam and low vacuum is making it tough for your power disc brakes to work properly, then this electric vacuum pump kit will solve your problems! A minimum of 16 inches of vacuum is critical to ensure that your power disc brakes are functioning and this kit ensures that your vacuum stays above that level so you will never have to worry about losing your brakes when you need them the most. The system automatically activates when the vacuum falls below that critical level and turns off when the engine is producing enough vacuum. This kit includes an efficient electric pump, relay switch, distributor with vacuum switch, wiring, hoses and brackets. This system requires a 12V negative ground system for operation.

EVPO1 Vacuum Pump Kit267.99 kit



FBC-799

Clutch Pedal Booster Rod Clip

Correct clutch pedal rod clip for power disc brake cars.

FBC-799 1967-816.99 ea.



BSL-38K

Booster To Master Nut Kit

Hardware to attach the booster to the master cylinder.

BSL-38 All0.50 ea.



AXP-0656

Power Brake Hose Kit

OEM hose with correct double circle Delco check valve, gasket and black phosphate clamps.

AXP-0656 1967-81.....21.95 kit



APN-0270

Power Brake Tube

Correct "pre-bent" tube with bracket for cars with power brakes (high quality zinc plated as original)

APN-7938 1968-69 All BB.....41.99 ea.
 APN-0270 1970 All BB.....30.99 ea.
 APN-71 1971-72 All BB.....30.99 ea.



APJ-1217

Power Brake Hose Bracket

Correct steel stamped retainer for holding power brake hose to valve cover.

APJ-1217 Most 1967-69 Z/28.....15.95 ea.



FBB-3715

Power Booster Boot

OE style reproduction of this often missing boot.

FBB-3715 1967-81 All.....16.95 ea.



FPV-05

1967-69 Distribution Block

Correct brake distribution block for factory drum or disc brakes. This valve is located under the master cylinder.

FPV-05 1967-69 All.....85.99 ea.



FPR-104E

1967-69 Hold Off Valve

Originally used to hold pressure to the rear brakes so the front brakes could engage a split second earlier to prevent fishtailing.

FPR-104E 1967-69 Disc.....62.95 ea.



FPR-104C

1970 Hold Off Valve

Originally used to hold pressure to the rear brakes so the front brakes could engage a split second earlier to prevent fishtailing.

FPR-104C 1970 Disc.....69.95 ea.



FPR-114

1967-68 Pro Valve

Correct brake proportioning valve for factory original disc brakes. This valve is located under the master cylinder and includes the bracket.

FPR-114 1967-68 w/ PDB.....84.95 ea.



FPV89

1969 Pro Valve

Correct brake proportioning valve for factory original disc brakes. This valve is located under the master cylinder.

FPV89 1969 w/ PDB.....96.99 ea.



FPV-7

1970 Pro Valve

Correct brake proportioning valve for factory original disc brakes. This valve is located under the master cylinder.

FPV-7 1970 w/ PDB.....89.95 ea.



FPR-102

1971-77 Pro Valve

OE style to original concourse level proportioning valve with correct wire lead for direct replacement.

FPR-102 1971-77 w/ PDB.....79.95 ea.



FBRK-71F

1971-77 Valve Bracket

Correct reproduction of this proportioning valve bracket unique to 1971-77 Camaros.

FBRK-71F 1971-81.....23.95 ea.

FPVB-3



FPV-BOOT

Proportioning Valve Bracket & Boot

Correct gold plated pro-valve bracket.

FPVB-3 1967-70 Bracket.....20.95 ea.
 FPV-BOOT All Boot.....6.95 ea.

PVK-71C



Proportioning Valve Kit

This is a universal proportioning valve that can be used on all cars when converting to disc brakes. Includes valve, bracket, harness and hardware. Choose from gold or chrome.

PVK-71COMBOKIT 2 Wheel Disc Gold.....95.95 kit
 PVK-72COMBO-KIT 4 Wheel Disc Gold.....95.00 kit
 PVK-71CK 2 Wheel Disc Chrome.....120.99 kit
 PVK-72CK 4 Wheel Disc Chrome.....98.99 kit
 MMC002 Brake Lines OM.....20.99 kit
 MMC002SS Brake Lines SS.....25.99 kit
 No Volume Discount.



Hurst Roll Control Line Lock

Used primarily in drag racing to provide positive locking action to the front wheels of race cars, reducing the chance of "Rolling the Lights" and producing more effective "Burn Outs" for heating up the tires.

HURST-1745000 All Universal Roll Control130.99 kit
 HURST-5671518 2010-15 Roll Control.....233.99 kit
 HURST-5671510 Installation Kit.....49.99 kit

No volume discount.



FRC4044

Single Piston Brake Calipers

New single piston loaded calipers complete with pads and all new hardware. Ready to install!

FRC4044	1967-69 LH.....	59.95 ea.
FRC4043	1967-69 RH.....	59.95 ea.
FRC-4060	1970-77 LH.....	61.95 ea.
FRC-4059	1970-77 RH.....	61.95 ea.
FRC-4124	1978-81 LH.....	84.95 ea.
FRC-4123	1978-81 RH.....	84.95 ea.

No Volume Discount.



FRC-4PSTL

4 Piston Brake Calipers

All new 4 piston calipers with Delco Moraine logo and casting numbers 5455530 and 5455533. Completely assembled.

FRC-4PSTL	1967-68 LH.....	236.99 ea.
FRC-4PSTR	1967-68 RH.....	236.99 ea.

Correct OEM style caliper inlet lines.

1967-68 4 Piston	OM	SS
FFC6701	3/8 x 3/8 LH.....	10.99 ea. 13.99 ea.
FFC6702	3/8 x 3/8 RH.....	10.99 ea. 13.99 ea.
FFC6703	3/8 x 7/16 LH.....	10.99 ea. 11.99 ea.
FFC6704	3/8 x 7/16 RH.....	10.99 ea. 13.99 ea.
FFC6705	3/8 x 1/2 LH.....	10.99 ea. 13.99 ea.
FFC6706	3/8 x 1/2 RH.....	10.99 ea. 12.99 ea.

1969 JL8		
FFCJL8L	3/8 x 1/2 LH.....	10.99 ea. 13.99 ea.
FFCJL8R	3/8 x 7/16 RH.....	10.99 ea. 13.99 ea.

No Volume Discount.



FRC-69FR FRC-69FB FRC-69FC

Powdercoated Calipers

These powdercoated calipers are a great finishing touch for any show car!

FRC-69FR*	1969 Red.....	169.99 kit
FRC-69FB*	1969 Black.....	169.99 kit
FRC-70FR	1970-77 Red.....	170.99 kit
FRC-70FB	1970-77 Black.....	170.99 kit
FRC-78FR	1978-81 Red.....	169.99 kit
FRC-78FB	1978-81 Black.....	169.99 kit

*1969 works on 1967-68 with single piston setup.



FMP-0200

Disc Brake Pads

New brake pad set.

FMP-0400	1967-68 4 Piston.....	49.99 set
FMP-0200	1969-81 1 Piston.....	36.95 set



FKW-4160

Caliper Backing Plates

OE style reproduction zinc backing plates.

FKW-4160	1967-68 4 Piston.....	70.99 pr.
FPP-11J	1969 1 Piston.....	39.95 pr.
FP-1K	1970-81.....	95.95 pr.
FPP-11GSK	1967-81 All Gasket.....	3.99 pr.

No Volume Discount.



BCP-373

Backing Plate Bolt

Correct bolt for attaching plate to spindle.

BCP-373	1969 Single Piston.....	2.99 ea.
---------	-------------------------	----------



FM-2501

Caliper Mounting Brackets

OE style reproduction caliper mounting brackets.

FM-155X	1967-68 4 Piston.....	133.99 pr.
FM-2501	1969 Single Piston.....	69.95 pr.



FBP-035

Disc Brake Retaining Pin

Correct pin for retaining 4 piston caliper brake pads to caliper. Two per caliper.

FBP-035	1967-68 4 Piston.....	4.99 ea.
---------	-----------------------	----------



BMP-1000

Brake Caliper Bolts

Correct bolts/pins for mounting caliper to bracket. Two per caliper.

BMP-1000	ALL Single Piston.....	2.99 ea.
----------	------------------------	----------



Deluxe Disc Brake Mini Kit

This deluxe disc brake mini kit contains essential parts to convert to your own disc brake setup or refurbish your factory set up. Includes spindles, caliper brackets, caliper backing plates, flex hoses, pro valve kit, bearing and seal kit and hardware.

FSK-69KIT 1969 with single piston calipers..... 219.99 kit
Can be used on 1968 when using 69 single piston calipers. No Volume Discount.



Basic Disc Brake Mini Kit

Basic kit for converting to disc brakes or restoring factory disc brake setup. Complete with 2 spindles, 2 caliper brackets, 2 caliper backing plates and 2 bolts.

FSK-69 1969..... 183.30 kit
Can be used on 1968 when using 69-72 single piston calipers. No Volume Discount.



FM-373B

FM-3712

Spindles

New OE spindles

FM-3712	1967-69 Disc.....	72.99 ea.
FM-1712	1967-69 Drum.....	95.95 ea.
FM-373B	Attaching Bolts.....	6.95 pr.



FSA-02

Steering Arms

OE style reproduction steering arms for your worn or missing originals.

FSA-02	1967-69.....	72.99 pr.
--------	--------------	-----------



FCDR-66

Drilled & Slotted Rotors

Drilled and slotted for maximum cooling and reduced fade; the ultimate in high performance braking and looks.

FCDR-66*	1969	130.99 pr.
*Works on 1967-68 with Single Piston Calipers.		
FCDR-7078	1970-78	160.99 pr.
FCDR-7981	1979-81	160.99 pr.



FBR-880

Rotors

New OEM style rotors.

FBR-780	1967-68 4 Piston	70.99 ea.
FBR-880	1969 All	68.99 ea.
FBR-880KIT	1969 Pair	99.95 pr.
FBR-990	1970-78 All	69.95 ea.
FBR-995	1979-81 All	72.95 ea.



FBR-2P

2 Piece Rotors

Available for the first time! All cars from 1967-69 originally came with 2 piece rotors from the factory. These 2 piece rotors duplicate the originals and are a must for a concours restoration.

FBR-2PK	1967-69 All Pair	224.98 kit
---------	------------------------	------------



FNW-103

Bearing Nut - Washer Kit

Correct castle nut, thrust washer and cotter pin. 2 kits are required per car.

FNW-103	1969-81 All	4.99 kit
---------	-------------------	----------

FBC-605	FBC-99
---------	--------



Bearing Cap

Original GM bearing & dust shield cap. 1967-69 features correct dimple.

FBC-605	1967-69 All	18.99 ea.
FBC-99	1970-81 All	14.99 ea.



FBK-67D

Bearing & Seal Kit

New GM bearing & seal kit (2) inners, (2) outers and (2) grease seals.

FBK-67D	1967-69 All w/ Disc	46.53 kit
---------	---------------------------	-----------

BUY'N SAVE WITH KITS

Parking Brake Cable Super Kits

These kits include everything you need to totally replace your old parking brake cables!

These kits come with (1) front cable, (1) intermediate cable (where applicable), (2) rear cables, (1) cable equalizer, (2) cable connectors, (2) frame hooks, (1) crossmember hook, and (3) cable retainer clips.

Available in original material (OM) or stainless steel (SS).

	OM	SS
PBSUKIT-67F	1967-69 All 100.99 kit	159.99 kit
PBSUKIT-70F	1970-74 All 99.99 kit	159.99 kit
PBSUKIT-75F	1975-81 All 98.99 kit	159.99 kit

No Volume Discount

PBSUKIT-67F



NQ-397

Parking Brake Guide

Correct hooks for supporting cables to crossmember.

NQ-397	1967-69 All	7.99 ea.
--------	-------------------	----------



NJ-4675

Brake Cable Connector

Correct U shaped zinc plated connector for connecting intermediate cable to rear cables.

NJ-4675	1967-81 All	3.95 ea.
---------	-------------------	----------



NJ-525

Brake Cable Equalizer

Correct support for connecting front cable to intermediate cable and provides equalizing tension for rear cables.

NJ-525	1967-81 All	4.95 ea.
--------	-------------------	----------



NX-281

Brake Cable Retainer

Correct clip for all cars (3 required).

NX-281	1967-92 All	1.99 ea.
--------	-------------------	----------



NQ-93

Brake Cable Support

Correct rear cable support bracket which mounts to the lower plates for multi leaf springs.

NQ-93	1967-69 Multi Leaf	23.95 ea.
-------	--------------------------	-----------



FPB-12-KIT-R

Parking Brake Shoe Bar

Correct horizontal bar for activating parking brakes.

FPB-11R	1967-81 All Rear	11.99 ea.
FPB-12-KIT-R	Lever/Spring Kit RH	32.99 kit
FPB-12-KIT-L	Lever/Spring Kit LH	32.99 kit

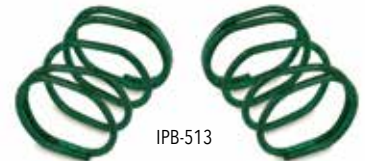

IPB-513

Parking Brake Guide Bar Springs

Correct green springs for 9.5 inch rear drum brakes.

IPB-513	1967-1981	6.99 pr.
---------	-----------------	----------



GBL-9EB

Parking Brake Light Switch

Mounts on the parking brake pedal and activates the light on your dash.

GBL-9EB	1967-69	19.95 ea.
GBL-99PC	1967-69 Bracket	16.95 ea.



IBA-67

E Brake Assemblies

OE style reproduction parking brake assemblies complete with correct pad and trim.

IBA-67	1967-68 All	64.95 ea.
IBA-69	1969 All	64.95 ea.

DRUM BRAKE PARTS



FD-95F

Brake Drums

Brand new brake drums.

FBD-95R	1967-81 Rear Finned	59.95 ea.
FD-95F	1967-69 Front Finned	59.95 ea.



F5-64R

Brake Shoes

Complete shoes for 2 drums.

F5-64R	1967-81 All Rear	29.95 pr.
FB5-64F	1967-69 All Front	32.95 pr.



FBP-41L

Backing Plates

New replacement rear drum backing plates.

FBP-41L	All LH	64.95 ea.
FBP-41R	All RH	64.95 ea.
FBP-41K	All LH/RH	116.91 kit
FPB-BOLT	Retaining Bolt/Nut	0.95 ea.



DBK67R2

Rear Drum Brake Kits

Now available as a complete kit! These reproduction kits include all new OEM parts, 9.5" drums, shoes, all hardware, backing plates, wheel cylinders and parking brake cables. They are complete and ready to bolt up.

One kit does both wheels.

DBK67R2	1967 All	425.95 kit
DBK69R2	1968-69 All	429.95 kit
DBK70R2	1970-74 All	425.95 kit
DBK75R2	1978-81 All	425.95 kit



FPK-1671

Brake Hardware Kit

Correct springs, rods, retainers, adjuster and clamp for mounting shoes to car. Does 2 wheels.

FPK-1671	All Front	41.48 kit
FPK-2642	All Rear	37.52 kit
FPK-REAR-KIT	All 9.5" Drums	155.95 kit



FBG-17

FAP-2R

Drum Brake Guide/Pin

FBG-17	Upper Guide Plate	5.95 ea.
FAP-2R	Attaching Pin Rear	16.95 ea.



FWC-01

Wheel Cylinders

New OEM wheel cylinders exact to original.

FWC-01	1967-69 Front LH	19.95 ea.
FWC-02	1967-69 Front RH	19.95 ea.
FWC-08R	1967-81 All Rear	19.95 ea.
BWC-100	Attaching Bolts	1.95 pr.



FCR-176

Wheel Cylinder Rods

Correct brake shoe thrust rods for engaging shoes. (2) required per cylinder.

FCR-176	1967-81 All	6.95 ea.
---------	-------------	----------

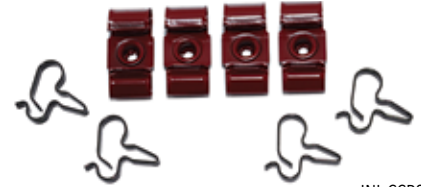

INL-CCB201

Brake Line Clip Kits

Complete brake line clip kits including all of the factory correct clips in the original colors.

INL-CCB201	1967-68 Brake Line Clip Kit (17 pc.)	25.95 kit
INL-CCB202	1969 Brake Line Clip Kit (25 pc.)	37.95 kit
INL-CCB203	1970 Brake Line Clip Kit (21 pc.)	31.95 kit
INL-CCB204	1971-73 Brake Line Clip Kit (25 pc.)	41.95 kit
INL-CCB205	1974-81 Brake Line Clip Kit (25 pc.)	39.95 kit



ELC-316

ELC-1316

ELC-516



ELC-038T

ELC-10P

BLC-056

Brake Line Clips

Correct clips for attaching hard brake lines to frame. (Tabbed clips push into frame holes.)

ELC-316	3/16" Front	2.99 ea.
ELC-1316	3/16" w/Tab	2.99 ea.
ELC-1516	5/16" Main	3.99 ea.
ELC-516	5/16" w/Tab	3.99 ea.
ELC-038T	3/8" w/Tab	3.95 ea.
ELC-10P	Double Push In	3.95 ea.
BLC-056	Clip Bolt	0.50 ea.

**Use on main line with armor shielding.*



FHB-789

1969 Disc Brake Hose Straps

Correct straps to secure the flex hose to the upper control arm.

FHB-789	1969 Disc	16.99 pr.
---------	-----------	-----------



INL-14999

1970-81 Master Cylinder Line Clamp

Correct sub-frame mounted clamp used to hold the hard brake lines to the hose bracket.

INL-14999	With Disc	12.99 ea.
-----------	-----------	-----------

THE RIGHT Stuff

Pre-Bent Brake Lines

Our OE style reproduction brake lines are crafted from original GM blueprints as well as from low mileage original cars. All lines feature correct double flared fittings, correct color coded nuts and correct coiled armor shields. Available in original material (OM) or stainless steel (SS). Our line kits are for original factory setups only and will not fit aftermarket conversions!



Close up of front lines

Front Line Kits

		OM	SS
FKT6702	1967 Manual (serial number below 135,000)	60.99 kit	90.99 kit
FKT6701	1967-68 Manual (serial number above 135,000)	60.99 kit	90.99 kit
FKT6703	1967-68 Power Drum	60.99 kit	90.99 kit
FKT6705	1967-68 Manual Disc	60.99 kit	90.99 kit
FKT6707	1967-68 Power Disc	60.99 kit	90.99 kit
FKT6901	1969 Manual Drum	60.99 kit	90.99 kit
FKT6903	1969 Power Drum & J/L8	60.99 kit	90.99 kit
FKT6905	1969 Power Disc	60.99 kit	90.99 kit
FKT6908	1969 Stock Power Disc Brake w/ Booster Removed	60.99 kit	90.99 kit
FKT7004	1970 Standard Manual Disc	71.99 kit	97.99 kit
FKT7005	1970 Power Disc Master Cylinder without Line Armor	71.99 kit	97.99 kit
FKT7006	1970 Power Disc Master Cylinder with Line Armor	71.99 kit	97.99 kit
FKT7101	1971 Manual Disc	60.99 kit	90.99 kit
FKT7102	1971-79 Power Disc	60.99 kit	90.99 kit
FKT8002	1980-81 Power Disc	60.99 kit	90.99 kit

Ships Oversize

Front to Rear Line Kits

		OM	SS
FIN6703	1967 (serial number below 135,000) 1pc	51.99 kit	72.99 kit
FIN6701	1967 (serial number above 135,000) 1pc	51.99 kit	72.99 kit
FIN6702	1967 2pc	51.99 kit	72.99 kit
FIN6801	1968 1pc	51.99 kit	72.99 kit
FIN6802	1968 2pc	51.99 kit	72.99 kit
FIN6901	1969 Power Disc or Drum 1pc	61.99 kit	82.99 kit
FIN6902	1969 Power Disc or Drum 2pc	61.99 kit	82.99 kit
FIN6903	1969 Manual Drum 1pc	61.99 kit	82.99 kit
FIN6906	1969 Manual Drum 2pc	61.99 kit	82.99 kit
FIN7001	1970 Power Disc 1pc	61.99 kit	82.99 kit
FIN7002	1970 Manual Disc 1pc	61.99 kit	82.99 kit
FIN7101	1971-73 Power Disc 1pc	61.99 kit	82.99 kit
FIN7401	1974-76 Power Disc 1pc	61.99 kit	82.99 kit
FIN7801	1977-81 Power Disc 1pc	61.99 kit	82.99 kit

Ship Oversize

Rear Axle Kits (pairs)

		OM	SS
FRA6702	1967 Mono Leaf Springs	26.99 kit	36.99 kit
FRA6802	1968 Mono Leaf Springs	26.99 kit	36.99 kit
FRA6805	1968 Multi Leaf Springs	26.99 kit	36.99 kit
FRA6902	1969 Multi Leaf Springs	26.99 kit	36.99 kit
FRA69JL	1969 J/L8	30.99 kit	41.99 kit
FRA7002	1970-74 All	26.99 kit	36.99 kit
FRA7801	1975-81 Std. Rear Suspension	26.99 kit	36.99 kit
FRA8002	1975-81 F-41 Rear Suspension	26.99 kit	36.99 kit

RSBK67



Front Flex Hose Brackets

These brackets hold the front flex hoses to the sub-frame.

FHB-12508	1967-69 Drum	27.95 pr.
RSBK67	1967-68 4 Piston Disc	28.99 pr.
FBC-1001	1969 Disc	41.99 kit
FBC-5000	1970-81 Disc 8pc	45.95 kit
FHB-7081	1970-81 Disc 2pc	36.95 pr.

FXB-105



Rear Flex Hose Brackets

Correct rear axle line flex hose brackets for all 12 bolt rear ends.

FXB-103	1967-68 All	13.95 ea.
FXB-105	1969 All	18.99 ea.
FHB-14409	1970-73 All	16.95 ea.
FHB-14410	1974-81 All	16.95 ea.



Front Flex Hoses

New OEM front flex hoses exact to original.

EBH-002

EBH-002	1967 Drum	21.99 ea.
EBH-002S	1967 Drum SS Braided	32.99 ea.
EBH-012	1968-69 Drum	14.99 ea.
EBH-012S	1968-69 Drum SS Braided	32.99 ea.
EBH-001	1967-68 Disc	21.99 ea.
EBH-001S	1967-68 Disc SS Braided	32.99 ea.
EBH-003	1969 Disc	21.99 ea.
EBH-003S	1969 Disc SS Braided	33.99 ea.
EBH-JL8	1969 J/L8	23.99 ea.
EBH-004	1970-71	21.99 ea.
EBH-007	1972-73	21.99 ea.
EBH-006	1974-76	26.99 ea.
EBH-008	1977-78	21.99 ea.
EBH-009	1979-81	24.99 ea.
FH7078S	1970-78 Disc SS Braided	72.95 pr.

Rear Flex Hoses

New OEM rear flex hoses exact to original.

EBH-04	1967 All	25.99 ea.
EBH-04S	1967 All SS Braided	32.99 ea.
EBH-05	1968 All	25.99 ea.
EBH-05S	1968 All SS Braided	32.99 ea.
EBH-06	1969 All	26.99 ea.
EBH-06S	1969 All SS Braided	34.99 ea.
EBH-10	1970-72 All	25.99 ea.
EBH-10S	1970-72 All SS Braided	32.99 ea.
EBH-11	1973 All	25.99 ea.
EBH-11S	1973 All SS Braided	32.99 ea.
EBH-12	1974-75 All	24.99 ea.
EBH-12S	1974-75 All SS Braided	32.99 ea.
EBH-13	1976-81 All	25.99 ea.
EBH-13S	1976-81 All SS Braided	32.99 ea.



EBB-691

Front Flex Hose Banjo Bolts

Correct OEM brake fluid bolt with hollow center and (2) special washers for attaching flex hose to caliper.

EBB-691	1969-92 w/ Disc Brakes	3.99 ea.
---------	------------------------	----------



EBC-22

Flex Hose Clip

Correct gold cadmium plated clip for retaining flex hose.

EBC-22	All	2.99 ea.
--------	-----	----------



FBLK-1

Flex Hose Block

Correct brass block for rear axle hose.

FBLK-1	1967-68 All	16.99 ea.
--------	-------------	-----------



BRH-11400

Rear Flex Hose Mounting Bolt

Used to secure hose to rear end bracket. 3/8" shank.

BRH-11400	1969	4.95 ea.
-----------	------	----------



E-DIX69

Value Front Suspension Kit

This kit is perfect for your daily driver or restoration on a budget. It includes all high quality imported suspension parts.

- 2 Upper Ball Joints
- 2 Lower Ball Joints
- 4 Lower Control Arm Bushings
- 2 Upper Control Arm Bushings
- 2 Outer Tie Rods
- 2 Inner Tie Tods
- 2 Stabilizer Ends Links
- 2 Adjuster Sleeves
- 2 Sway Bar Bushings

E-DIX69 1967-69 All 182.84 kit

No volume discount.



3-18119G

Energy Suspension Hyperflex Kit

These complete Hyperflex kits include all the bushings for the suspension, subframe and include a transmission mount.

Add G to the part number for black. Add R to part number for red.

Example. 3-18119G is for 67-81 in black.

3-18118G	1967-69 Multi Leaf	272.99 kit
3-18119_	1967-69 Mono Leaf	272.99 kit
3-18116_	1975-79 ALL	334.99 kit
3-18131_	1982-92 ALL	168.99 kit
3-18130_	1993-02 ALL W/V8*	248.99 kit

* Except 1LE Suspension



DIX-69

Deluxe Front Suspension Kit

This is the ultimate suspension kit!
Each kit includes the finest quality components.

- 2 Upper Ball Joints
- 4 Lower Control Arm Bushings
- 2 Lower Ball Joints
- 4 Upper Control Arm Bushings
- 2 Outer Tie Rods
- 2 Stabilizer Ends Links
- 2 Inner Tie Tods
- 2 Adjuster Sleeves
- 1 Idler Arm

DIX-69 1967-69 All 291.28 kit

Ships Oversized. No volume discount.



DJR-69

Junior Front Suspension Kit

This kit is perfect for freshening up your front suspension!
Each kit includes the finest quality components.

- 2 Upper Ball Joints
- 4 Lower Control Arm Bushings
- 2 Lower Ball Joints
- 4 Upper Control Arm Bushings
- 2 Outer Tie Rods
- 2 Stabilizer Ends Links

DJR-69 1967-69 All 185.14 kit

Ships Oversized. No volume discount.



6874SFK-P

Polygraphite Complete Front End Kit

For the ultimate in performance, install a polygraphite front end kit! This kit offers increased longevity and better performance than the stock rubber front end components. Kits includes upper and lower ball joints, inner and outer tie rods, tie rod adjusting sleeves, idler arm and control arm bushing kit and bump stops.

6874SFK-P 1967-69 All 338.66 kit

End link kit sold separately. No Volume Discount.



6874FK-P

Polygraphite Basic Front End Kit

Polygraphite bushings used in this kit are the ultimate combination of polyurethane and graphite. You get performance and durability with superior lubricating qualities which provides smooth operation. Kits include upper and lower ball joints, outer tie rods, control arm bushing kit and lower bump stops.

6874FK-P 1967-69 All 228.37 kit

No Volume Discount.

AMK inc
PRODUCTS



Master Chassis Kit

Typical kit includes fasteners to attach: accelerator lever & support, axle housing springs, axle retainer plates, brake booster & hose, brake cables, brake plates, brake hose retainers & brackets, brake valve & pressure switch, calipers & brackets & shields, upper & lower control arms, control arm bushings, differential cover, driveshaft, engine mounts, fuel filler neck cover, fuel hoses, gas tank, grease fittings, idler arm, leaf spring hangers & front eye, master cylinder & push rod, parking brake control, pitman arm, radius rod & bracket & bumper, shackles (nuts), shocks & brackets, stabilizer bar brackets and end links (includes rubber), steering gear & rag joint, steering linkage & ball joints, speedometer cable trans, suspension bumper, transmission crossmember & insulator, wheel cylinders.

67FS-BB	1967 BB Disc Brakes Mono Leaf	306.99 kit
67FS-DCSB	1967 SB Disc Brakes Mono Leaf	305.99 kit
67FS-DRSB	1967 SB Drum Brakes Mono Leaf	277.99 kit
67FS-L78	1967 BB L-78 Disc Brakes Mono Leaf	326.99 kit
67FS-Z28	1967 SB Z/28 Disc Brakes Mono Leaf	326.99 kit
68FS-BB	1968 BB Disc Brakes Mono Leaf	314.99 kit
68FS-DCSB1	1968 SB Disc Brakes Mono Leaf	315.99 kit
68FS-DCSB4	1968 SB Disc Brakes Multi Leaf	305.99 kit
68FS-DRSB1	1968 SB Drum Brakes Mono Leaf	278.99 kit
68FS-DRSB4	1968 SB Drum Brakes Multi Leaf	308.99 kit
69FS-BB	1969 BB Disc Brakes Multi Leaf	326.99 kit
69FS-DCSB1	1969 SB Disc Brakes Mono Leaf	323.99 kit
69FS-DCSB4	1969 SB Disc Brakes Multi Leaf	332.99 kit
69FS-DRSB1	1969 SB Drum Brakes Mono Leaf	301.99 kit
69FS-DRSB4	1969 SB Drum Brakes Multi Leaf	299.99 kit
70FS-BB	1970-71 BB Disc Brakes Multi Leaf w/ Swaybar	333.99 kit
70FS-F41SB	1970-71 SB Disc Brakes Multi Leaf w/ Swaybar	329.99 kit
70FS-SB	1972 SB Disc Brakes Multi Leaf	335.99 kit
72FS-BB	1972 BB Disc Brakes Multi Leaf w/ Swaybar	318.99 kit
72FS-F41SB	1972 SB Disc Brakes Multi Leaf w/ Swaybar	327.99 kit
72FS-SB	1972 SB Disc Brakes Multi Leaf	327.99 kit
73FS-F41SB	1973 SB Disc Brakes Multi Leaf w/ Swaybar	327.99 kit
73FS-SB	1973 SB Disc Brakes Multi Leaf	327.99 kit
74FS-S	1974 SB Disc Brakes Multi Leaf	276.99 kit
74-FS-F41	1974 SB Disc Brakes Multi Leaf F41	288.99 kit
75FS-S	1975-76 SB Disc Brakes Multi Leaf	280.99 kit
75-FS-F41	1975-76 SB Disc Brakes Multi Leaf F41	296.99 kit
77FS-S	1977 SB Disc Brakes Multi Leaf	288.99 kit
77-FS-F41	1977 SB Disc Brakes Multi Leaf F41	315.99 kit
78FS-S	1978-79 SB Disc Brakes Multi Leaf	360.99 kit
78-FS-F41	1978-7 SB Disc Brakes Multi Leaf F41	316.99 kit
80FS-S	1980-81 SB Disc Brakes Multi Leaf	327.99 kit
80-FS-F41	1980-81 SB Brakes Multi Leaf F41	320.99 kit

No Volume Discount.

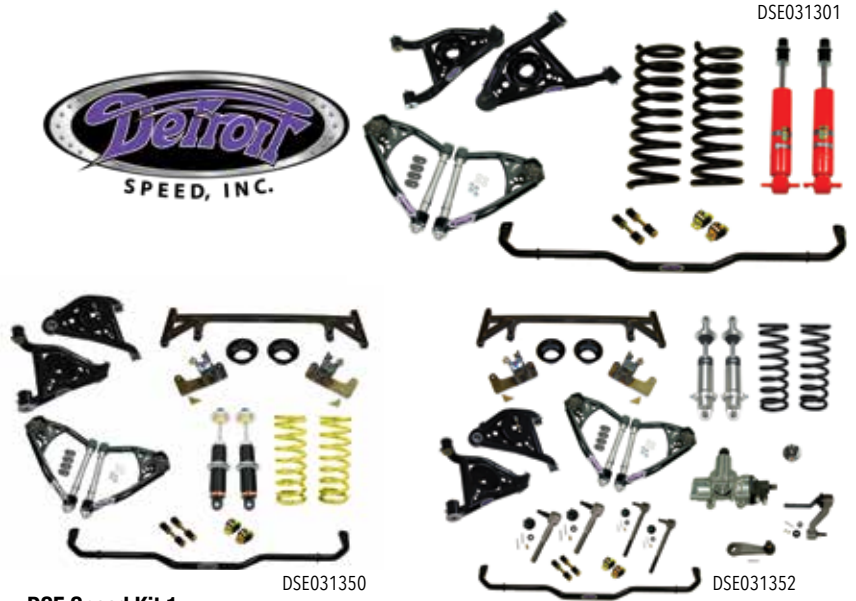

DSE Speed Kit 1

This exclusive DSE Speed kit is a complete bolt-on suspension upgrade system designed for ease of installation with no modification to subframe. This kit includes:

- Tubular Upper & Lower Control Arms • Front Sway Bar • Koni Classic Front Shocks • Front 2" Drop Springs

DSE031301	1967-69 SB, LS	2224.99 kit
DSE031304	1967-69 BB	2224.99 kit
DSE031307	1970-81 SB, LS	2274.99 kit
DSE031308	1970-81 BB	2274.99 kit

DSE Speed Kit 2

Speed kit 2 improves the handling and performance to the next level and offers ride height adjustment. This kit includes:

- Tubular Upper & Lower Control Arms • Coilover Conversion Kit • Front Sway Bar • Coilover Springs

Base Shock

DSE031350	1967-69 SB, LS	2549.99 kit
DSE031351	1967-69 BB	2549.99 kit
DSE031354	1970-81 SB, LS	2599.99 kit
DSE031355	1970-81 BB	2599.99 kit

Single Adjustable Shocks

DSE031350S	1967-69 SB, LS	2999.99 kit
DSE031351S	1967-69 BB	2999.99 kit
DSE031354S	1970-81 SB, LS	3049.99 kit
DSE031355S	1970-81 BB	3049.99 kit

Double Adjustable

DSE031350D	1967-69 SB, LS	3599.99 kit
DSE031351D	1967-69 BB	3599.99 kit
DSE031354D	1970-81 SB, LS	3599.99 kit
DSE031355D	1970-81 BB	3599.99 kit

DSE Speed Kit 3

Speed Kit 3 is the most advanced handling system that you can buy for your stock subframe and gives you the steering performance of today's modern cars.

- Tubular Upper & Lower Control Arms • Pitman Arm • Coilover Conversion Kit • Idler Arm • Front Sway Bar • Coilover Springs • DSE 600 Gear w/ Rag Joint
- DSE Tie Rod Adjusters • Inner & Outer Tie Rod Ends

Base Shock

DSE031352	1967-69 SB, LS	3361.99 kit
DSE031353	1967-69 BB	3361.99 kit

Call for 1970-81 Applications.

Single Adjustable Shocks

DSE031352S	1967-69 SB, LS	3704.99 kit
DSE031353S	1967-69 BB	3704.99 kit

Call for 1970-81 Applications.

Double Adjustable

DSE031352D	1967-69 SB, LS	4305.99 kit
DSE031353D	1967-69 BB	4140.99 kit

Call for 1970-81 Applications.

All Speed Kits Ship Oversized. No volume discount.

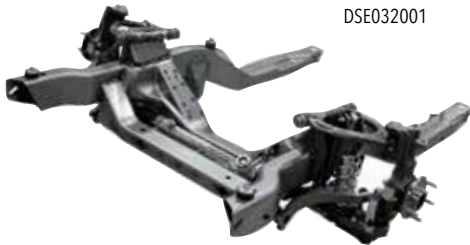

DSE032001

DSE Hydroformed Subframe

DSE's all new front subframe is a bolt-in replacement for the original stock subframe. It improves the handling and ride quality by utilizing DSE's unique suspension geometry. It is the ONLY subframe in the aftermarket industry with hydroformed frame rails. The hydroformed frame rails feature strength and stiffness, precise quality and repeatability.

This subframe comes complete with: • C6 Corvette upright • Tubular upper and lower control arms • Splined sway bar • Coilover shocks and springs • Power Rack & Pinion Steering
Up to a 10" wide wheel can be packaged without modification to the inner wheel wells.
SB, BB, LS1, LS2 and LS7 engines can be directly bolted in.

Subframe in Bare Metal, Unassembled

DSE032001	1967-69 SB Chevy or LS.....	6990.99 kit
DSE032002	1967-69 BB Chevy	6990.99 kit
DSE032011	1970-81 SB Chevy or LS.....	7184.99 kit
DSE032012	1970-81 BB Chevy	7184.99 kit

Subframe with Black Powdercoat, Assembled

Subframe is satin black. Upper and lower control arms and sway bar are gloss black.

DSE032004	1967-69 SB Chevy or LS.....	8399.99 kit
DSE032005	1967-69 BB Chevy	8399.99 kit
DSE032014	1970-81 SB Chevy or LS.....	9399.99 kit
DSE032015	1970-81 BB Chevy	9399.99 kit

Ships Truck Freight to a commercial address.
No volume discount.



DSE010101

DSE Subframe Connectors

These uniquely designed DSE weld in subframe connectors increase your car's stiffness by connecting the front subframe to the rear frame rails. Unlike others, the DSE subframe connectors are barely visible from underneath the car. DSE subframe connectors do not interfere with seat attachment hardware or the installation and removal of the rear leaf spring pocket.

DSE010101	1967-69 All	214.99 pr.
DSE010103	1970-81 All	249.99 pr.



DSE030101

DSE031201

DSE031204



DSE030201



DSE030401

DSE Tubular Upper Control Arm Kit

These DSE tubular upper control arms are a direct replacement for your stock control arms and offer better suspension geometry and more strength, which equals better handling and performance. Everything needed to install these new control arms is included in this COMPLETE kit.

DSE030101	1967-69 All	698.99 kit
DSE030102	1970-81 All	698.99 kit

Installation should be followed by a professional alignment.
Ships Oversized. No volume discount.

DSE Tubular Lower Control Arm Kit

These DSE tubular lower control arms are a direct replacement for your stock control arms and offer better suspension geometry and more strength which equals better handling and performance. Everything needed to install these new control arms is included in this COMPLETE kit.

DSE031201	1967-69 w/ Stock Springs.....	724.99 kit
DSE031204	1970-81 All	794.99 kit

Installation should be followed by a professional alignment.
Ships Oversized. No volume discount.

Delrin Lower Bushings

These Delrin bushings eliminate deflection and greatly improve response. The steel outer housings can be welded to the control arm.

DSE030201	1967-69 All	155.99 kit
-----------	-------------------	------------

Works great for street cars as well as race cars.

Urethane Upper Bushings

These urethane bushings are designed as an upgrade over stock for improved handling.

DSE030401	1967-69 All	61.99 kit
-----------	-------------------	-----------

DSE Bounce Bumpers

These urethane bumpers can be used for bounce and rebound control for your stock control arms. The bumper dimensions are 1-9/16" tall and 1-5/8" base diameter.

DSE030501	1967-69	17.99 pr.
-----------	---------------	-----------



DSE Rear Coilover Suspension Kit

This DSE 3rd generation Camaro Coilover Conversion Kit allows the latest in coilover spring/shock technology to be bolted on, bringing your cars handling and ride into the 21st century with our Detroit Tuned valving. The standard coilover package offers extensive ride height adjustability and is optimized around a 2 in. drop from stock height. Installation requires only minor drilling on the existing axle bracket. Standard shocks have no rebound or compression valving adjustment, single adjustable means you can adjust the rebound dampening, double adjustable means you can adjust both compression and rebound dampening.

DSE042440	1982-92 Standard.....	1254.99 kit
DSE042440S	1982-92 Single Adjustable.....	1749.99 kit
DSE042440D	1982-92 Double Adjustable	2349.99 kit

No volume discount.



DSE060401

DSE Engine Mounting Bracket Kits

The DSE engine mount bracket kits enable easy, no hassle installation of any SBC, BBC or LS engine into the DSE hydroformed subframe. Includes frame side engine mount stands, CNC aluminum adapter plates and polyurethane engine mounts.

DSE060401	1967-69 LS.....	324.99 kit
DSE060411	1970-81 SB, BB.....	294.99 kit
DSE060414	1970-81 LS.....	374.99 kit
DSE060435	1982-92 LS*.....	324.99 kit

* Moves engine 3/8 inch back from stock V8 engine location.



DSE090101B

DSE Tubular Adjustment Sleeves

Tubular tie rod adjusters improve the strength and integrity of your steering system over stock. The tubular design is stiffer than the OEM split clamp adjuster and weighs less.

- DSE090101B 1967-69 Black.....72.99 kit
 - DSE090102B 1970-81 Black.....72.99 kit
- No Volume Discount



DSE040110

Heavy Duty Leaf Spring Pocket Kit

The Detroit Speed Heavy Duty Leaf Spring Pocket Kit was engineered to work with stock leaf spring cars as well as cars with the Detroit Speed QUADRALink installed. The kit is significantly stronger than the stock pocket, connects into the doubler plate on the top side floor plan and offers an additional link mounting location that is lower than the stock location. The assembly is bolt-on for easier installation and may be removed after painting. The lower link pocket comes powdercoated and the kit comes with all hardware for installation.

- DSE040110 1967-69 All 424.99 kit
- No Volume Discount.



DSE031101



DSE031115

DSE Coilover Springs

These springs provide an excellent balance of handling, performance and ride quality. They are designed to work with our DSE front coilover conversion bracketry kit.

- DSE031101 1967-69 SB/LSX..... 249.99 pr.
- DSE031102 1967-69 BB..... 148.99 pr.

DSE 2" Dropped Front Coil Springs

These DSE 2" drop coil springs will lower the front of your Camaro easily to give it a pro-touring stance. These springs will also provide great ride and handling.

- DSE031115 1967-69 SB, LSX..... 212.99 pr.
- DSE031118 1967-69 BB..... 258.99 pr.
- DSE031107 1970-81 SB, LSX..... 258.99 pr.
- DSE031108 1970-81 BB..... 258.99 pr.

Ride height may vary depending on weight differences of cars.



DSE010801

DSE010201

DSE Solid Body Mounts

DSE solid body mounts provide a simple approach to eliminating the flex that occurs between the body and sub frame connection. CNC machined from billet aluminum and then hard coated. Stainless bolts sold separately.

- DSE010201 1967-81 1/2 Height..... 156.99 kit
- DSE010301 1967-81 Stock Height..... 168.99 kit
- DSE010801 Stainless Bolts 114.99 kit

No Volume Discount



DSE031401

Detroit Speed Front Sway Bar Kit

Improve cornering and reduce body roll with this larger diameter hollow sway bar. This larger than stock bar is powdercoated black and comes with everything you need to bolt it on, including greasable polyurethane bushings and end links.

- DSE031401 1967-69 All 1-1/8" Hollow.....259.99 kit
 - DSE031402 1970-81 All 1-3/8" Hollow.....274.99 kit
- No Volume Discount. Ships Oversize 2.



DSE041601

DSE Rear Speed Kit 1

This DSE rear leaf spring suspension kit works great with any DSE front suspension kit. These leaf springs improve handling due to the increased spring rate and are available in either a 2" or 3" dropped ride height. Includes DSE rear leaf springs, heavy duty shackles kit and Koni classic rear shocks.

- DSE041601 1967-69 2" Drop Multi.....894.99 kit
- DSE041602 1967-69 3" Drop Multi.....894.99 kit
- DSE041631 1967-69 2" Drop Mono.....924.99 kit
- DSE041632 1967-69 3" Drop Mono.....924.99 kit
- DSE041637 1970-81 2" Drop Multi.....924.99 kit
- DSE041636 1970-81 3" Drop Multi.....924.99 kit

No Volume Discount. Ships Oversize 2. Ride height may vary depending on weight differences of cars.



Shown on mock up rear end.
Rear end not included

DSE041703

DSE Quadralink Kit

A great way to upgrade from your original leaf spring rear suspension. Unlike other kits on the market, DSE's exclusive new 4-link geometry design is uncompromised to achieve the best possible handling. The DSE Swivel Link allows the suspension to fully articulate with smooth, solid motion and no binding. The rear upper shock crossmember strengthens the rear body and frame section. This kit also includes coilover shocks and springs.

- DSE041703 1967-69 Complete Kit 2755.99 kit
- DSE041711 1970-81 Complete Kit 2911.99 kit

Note: Axle brackets require a 3" axle tube.

Does not include rear end. Ships Oversized. No volume discount.

DSE Quadralink Rear Sway Bar Kit

A great complement to the DSE QUADRALink™! The adjustable sway bar provides an additional way to upgrade the rear suspension.

- DSE042203 1967-69347.99 kit
- Ships Oversized. No volume discount.



DSE041222

DSE Mini Tub Kit

This is a complete Detroit Speed & Engineering mini tub kit which includes all of the necessary parts for a complete project package. The original rear seat back and bottom frames must be slightly modified, but the rear seat can be used!

- DSE Deep Tubes • Rear Upper Shock Crossmember
- Front Leaf Spring Pockets (1970-81) • Upper Shock Mounts • Offset Shackles • Rear Leaf Springs • U Bolts • Mini Tub Shocks (1970-81 only) • Adjustable Leaf Spring Pads • Lower Shock Plates • Rear Leaf Delrin Bushing Kit (1970-81 only) • Steel Frameraill Fill Panels (1970-81 only)

- DSE041203 1967 w/ 2" Drop Springs..... 1799.99 kit
- DSE041204 1967 w/ 3" Drop Springs..... 1799.99 kit
- DSE041205 1968-69 w/ 2" Drop Springs 1799.99 kit
- DSE041206 1968-69 w/ 3" Drop Springs 1799.99 kit
- DSE041301 1967-81 Mini Tub Rear Shocks..... 239.99 pr.
- DSE041222 1970-81 w/ 2" Drop Springs 2219.99 kit
- DSE041223 1970-81 w/ 3" Drop Springs 2219.99 kit

A narrowed fuel tank is required. Ask your sales rep for details!

These kits require a 3" axle tube. DSE041301 shocks required for 1967-69. Ships Oversized. No volume discount.



DSE090204

600 Steering Gear

DSE's 600 steering gearbox provides you with rack and pinion performance with a bolt in steering gear. Choose from paintable finish or ceramic coated.

- All new, not rebuilt!
- Increased steering feel due to low friction gear design!
- Precision rack and pinion valve technology!
- Late model performance car feel!
- Quick ratio 12.7:1!
- Original power pitman arm may be used!
- 6 pounds lighter than stock!

- DSE090204 1967-81 Bare794.99 ea.
- DSE090204C 1967-81 Coated.....1093.95 ea.
- DSE091202 1967-81 Braided Hose Kit 194.99 kit
- DSE090205 1967-81 Steering Coupler 98.99 ea.

Note: Part number DSE 090205 rag joint and DSE 091202 hose kit are required with this box. Ships Oversize. No Volume Discount.

ENERGY SUSPENSION
Performance POLYURETHANE Components

Control Arms

OE style reproduction upper control arms with ball joint shaft and bushings. OE style reproduction lower control arms are loaded with ball joint and bushings. All control arms are powdercoated in correct semi gloss black and are ready to install. Control arms are available individually or as a specially priced complete kit!



KAR-KIT

OEM BUY'N SAVE WITH KITS

KAR-KIT	1967-69 Complete Control Arm Kit.....	418.03 kit
KAU-6L	1967-69 Upper LH Only.....	115.95 ea.
KAU-6R	1967-69 Upper RH Only.....	115.95 ea.
KAL-9L	1967-69 Lower LH Only.....	129.95 ea.
KAL-9R	1967-69 Lower RH Only.....	129.95 ea.

Ships Oversize. No volume discount.



DS-594

Control Arm Shims

DS-594	1/16	2.95 ea.
DS-595	1/8.....	2.95 ea.



UCA6769-KIT

Tubular Control Arms

Tubular control arms include everything you need to bolt them on and go. They are black powdercoated for a nice looking and long lasting finish. Uppers come loaded with bushings, ball joints and shafts. Lower come loaded with bushings and ball joints.

UCA6769-KIT	1967-69 Uppers/Lowers	397.43 kit
-------------	-----------------------------	------------



9-9151G

9-9154G

Energy Suspension Control Arm Bumpers

These polyurethane control arm bumpers offer increased performance and longevity over stock. Add G to the part number for black. Add R to part number for red.

Example. 3-2134G is for 67-81 in black.

9-9151_	1967-69 All Upper	10.99 pr.
9-9154_	1967-69 All Lower	19.99 pr.
ENGGIT-1_	1967-69 Upper & Lower Kit	27.88 kit



DCE-2410

DCE-4220

Control Arm Bumpers

Correct upper and lower control arm bumpers.

DCE-4220K	1967-69 Kit 4pc.....	23.85 kit
DCE-4220	1967-69 Upper.....	7.95 ea.
DCE-67L	1967 Lower.....	13.99 ea.
DCE-2410	1968-69 Lower.....	7.95 ea.
DCE-2014	1970-81 Upper.....	8.95 ea.
DCE-9222	1970-92 Lower.....	12.95 ea.



FA-1019

Control Arm Shaft Kit

New OEM shaft, bushings, washers & nuts.

FA-1019	1967-69 All	49.99 kit
FA-7073	1970-73 All	62.95 kit
FA-7479	1974-79 All	62.95 kit
FA-8081	1980-81 All	39.95 kit

FB-149



FB-6076

Upper Arm Bushings

FB-149	1967-69 All	6.95 ea.
FB-329	1970-73 All	14.95 pr.
FB-749	1974-79 All	21.00 pr.
FB-801	1980-81 All	16.99 pr.

Lower Arm Bushings

FB-6076	1967-72 All	19.95 pr.
FB-7381	1973-81 All	21.00 pr.

ENERGY SUSPENSION
Performance POLYURETHANE Components



Energy Suspension Control Arm Bushings

These polyurethane body bushings offer increased performance and longevity over stock. Add G to the part number for black. Add R to part number for red. Example. 3-2134G is for 67-81 in black.

3-3101_	1967-69 All	85.99 kit
3-3102_	1970-72 All	85.99 kit
3-3103_	1973-74 1 5/8" Lower	85.99 kit
3-3104_	1973-74 1 3/8" Lower	85.99 kit
3-3105_	1975-79 All	85.99 kit



Upper Control Arm Bolt & Washer Kit BPX-8542

Correct heavy cup washers and correct OEM bolts for retaining upper bushings into arms.

BPX-8542	1967-69 All	19.95 kit
----------	-------------------	-----------



BPX-0918

BPB-1430

Control Arm Bolt Kit

Correct OEM serrated bolts with special locking nuts.

BPX-0918	1967-69 All	18.99 kit
BPX-0919	1970-81 All	19.99 kit

Lower Control Arm Bolt

Original GM bolt with correct reduced body shaft and pointed end. Includes correct locking nut.

BPB-1430	1967-72 All	7.99 ea.
BPB-1450	1973-81 All	6.99 pr.



BUY'N SAVE
WITH KITS



DBB-67K

Body Mounting Kits

Complete with everything you need to mount your body to the frame including correct rubber bushings with steel inserts and factory style OEM flanged head frame bolts with washers!

DBB-67K 1967-81 All55.17 kit



BPB-2230



DRS-67H

Body Bolt Kit

Correct OEM body mounting kit complete with (4) correct body bolts, (4) correct large washers, (2) correct radiator support bolts, (2) bushing washers, (2) correct spacer washers and (2) nuts & lock washers.

BPB-2230 1967-8124.95 kit



DCI-3025

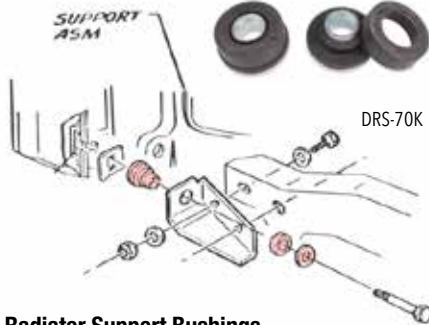

DRS-70K

Body Mounting Bushing Kit

Correct OEM style rubber bushings with steel inserts for mounting body to frame complete with radiator support bushings.

DCI-3025 1967-8139.95 kit

Radiator Support Bushings

Complete kit with all bushings and hardware for mounting radiator support to car.

DRS-67H 1967-81 All21.52 kit
DRS-70K 1970-73 Side Bushings*26.99 kit

*Not to Frame. Does Not Include Hardware.



Front Rad. Support

Middle

Rear



Energy Suspension Body Mounting Kit

These polyurethane body mounts offer increased performance and longevity over stock.

Add G to the part number for black. Add R to part number for red. Example: 3-2134G is for 67-81 in black.

3-4142_ 1967-81 All88.99 kit

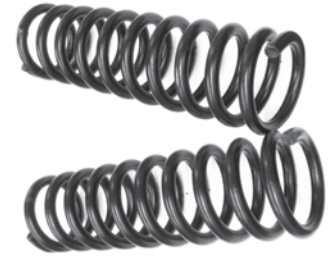

Coil Springs

Brand new OEM replacement coil springs sold in matched pairs. These are not cheap aftermarket springs. These springs will restore your car to the original ride height.

DCS-0009	1967-69 SB w/o AC	91.99 pr.
DCS-0010	1967-69 SB w/ AC	89.99 pr.
DCS-0010	1967-69 BB w/o AC	89.99 pr.
DCS-1160	1967-69 BB w/ AC	109.99 pr.
DCS-5276	1970-74 SB w/o AC	84.99 pr.
DCS-5278	1970-74 SB w/ AC	109.99 pr.
DCS-5006	1975-81 SB w/o AC	99.99 pr.
DCS-576	1975-81 SB w/ AC	99.99 pr.
DCS-586	1977-79 Z/28 and HD w/ AC	119.99 pr.
DCS-6486	1980-81 Z/28 and HD w/ AC	109.99 pr.
DCS-70BB	1970-81 BB w/o AC	119.99 pr.
DCS-70BBAC	1970-81 BB w/ AC	109.99 pr.

DSI-170



Coil Spring Insulators

Correct rubber insulators for the top of the front coils.

DSI-170 1967-81 All17.99 pr.

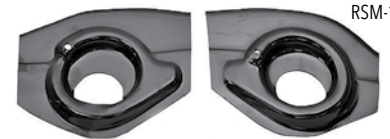

RSM-1003B

Coil Spring Upper Mounts

Replacement coil spring upper mounts which are part of the subframe. Weld in.

RSM-1003B 1967-6934.95 pr.



RFR-646

SubFrame Repair Plates

Stamped steel plates for repairing your rusted or damaged subframe mounting points. Complete set of (6) includes radiator support.

RFR-646 1967-81*56.99 kit

*Modifications will be required to fit 70-81 applications.



DPX-310

GM Shock Kit

Complete kit featuring 4 gas charged shocks, correct front & rear hardware, shock gray paint & 4 shock ID decals.

DPX-310	1967-69 All w/ Multi Leaf.....	128.96 kit
DPX-320	1970-81 All	140.86 kit
NT-2005	1967-81 Front Only.....	29.99 ea.
NR-1010	1968-69 Rear Only for Multi Leaf.....	29.95 ea.
NT-88R	1970-81 Rear Only.....	36.95 ea.

No Volume Discount.



KYB-68F

KYB Excel-G Shock Kit

Are you looking for more performance from your shocks and a smooth ride? This KYB shock kit is the answer! They feature velocity sensing valving, hard chrome pistons rods, twin tube design, low pressure nitrogen gas to prevent foaming of the oil, iron pistons & guide tubes. These shocks are great for normal to moderate driving! Our kit includes: 2) front shocks, 2) rear shocks and hardware.

KYB-679F-KIT	1967-69 All Front & Rear.....	114.95 kit
KYB-781F-KIT	1970-81 All Front & Rear.....	114.95 kit
KYB-68F	1967-69 Front Only.....	34.95 ea.
KYB-64F	1970-81 Front Only.....	34.95 ea.
KYB-679R	1967-69 Rear* Only.....	29.95 ea.
KYB-64F	1970-81 Front Only.....	34.95 ea.
KYB-70R	1970-81 Rear Only.....	31.95 ea.
KYB-107	1967-69 Rear Mono Leaf Adapter ...	14.95 ea.

*Must use KYB-107 for cars with mono leaf springs.
No volume discount.



DSS-F72

Spiral Shocks

New GM licensed reproductions of the original spiral twist shocks in correct gray color.

DSS-F72	1967-69 All Front No Part #'s.....	89.99 ea.
3192419	1967-69 Front GM #3192419	96.99 ea.
3192477	1967-69 Front Z/28 GM #3192477	89.95 ea.
3192831	1968-69 Rear Multi No #'s.....	96.99 ea.
DSS-67M	1967-69 Rear Mono No #'s.....	96.99 ea.
DSS-69M	1967-69 Rear Multi GM #3192832.....	8.95 ea.
3192831	1967-69 Rear Mono GM #3192831.....	96.99 ea.
3192851	1967-69 Rear Z/28 GM #3192851	96.99 ea.

No Volume Discount



Koni Front & Rear Shock Kits

Are you looking for more performance from your Camaro's shocks, and a smooth ride with improved ride and handling qualities? This Koni shock kit is the answer! Koni Classic shocks provide modern shock absorber technology for early muscle cars. Our kit includes: (2) front shocks, (2) rear shocks.

KONI679FMO	1967-69 Mono Leaf.....	432.36 kit
KONI679FMU	1967-69 Multi Leaf.....	451.16 kit
KONI7081F	1970-81 Multi Leaf.....	469.96 kit

No volume discount.



AAS-GSK-6769B



Ground Up Exclusive Aldan Front Suspension Kits

Ground Up's exclusive front suspension kit has the parts you need to upgrade your Car's handling. We bundle together Ground Up's Tubular Front Control Arms and a set of Aldan American Coil-Overs in a specially discounted package. With Ground Up's exclusive front suspension kit, you'll be carving the corners in no time!

AAS-GSK-6769S	1967-69 Small Block.....	836.93 kit
AAS-GSK-6769B	1967-69 Big Block.....	836.93 kit

No volume discount.



AAS-300116

Aldan American Coil Over Kits

Aldan Road Comp kits are designed to convert your suspension to coil-overs. Aldan Phantom Series, single adjustable coil-overs deliver superior handling and ride quality for a drastic improvement over stock suspension. Aldan High tensile, high travel coil-springs provide greater consistency over stock springs. Aldan's rear bolt-on shock absorber kit includes 2 TrueLine Series shocks, 2 brackets, 2 T-Bars and hardware. Uses OEM shock mounting locations. TrueLine adjustable shock absorbers are designed to work with factory and aftermarket springs to add a more consistent, smoother ride.

Complete Front & Rear Kits

AAS-300114	1967-69 SB Mono Leaf.....	910.99 kit
AAS-300115	1967-69 BB Mono Leaf.....	910.99 kit
AAS-300116	1967-69 SB Multi Leaf.....	910.99 kit
AAS-300117	1967-69 BB Multi Leaf.....	910.99 kit
AAS-300108	1970-81 SB All.....	905.99 kit
AAS-300109	1970-81 BB All.....	905.99 kit

Front Coil Over Kits

AAS-AFBFMS	1967-69 450lb Springs.....	518.99 kit
AAS-AFBFHS	1967-69 550lb Springs.....	518.99 kit
AAS-AFBFMS3	1970-81 450lb Springs.....	513.99 kit
AAS-AFBFHS3	1970-81 550lb Springs.....	513.99 kit

Rear Shock Kits

AAS-100103	1967-69 Mono Leaf.....	392.99 kit
AAS-100104	1967-69 Multi Leaf.....	392.99 kit
AAS-100101	1970-81 All.....	392.99 kit

Thrust Bearing Set

Thrust bearings make it easier to adjust spring tension and ride height when installed at the base of a coil spring and coilover spring seat. Includes 2 thrust bearings and 4 steel washers. 2.5 in. inner diameter, 3.225 in. outer diameter.

AAS-ALD-27	Bearings & Spanner Wrench.....	67.99 kit
AAS-ALD-26	Bearings Only.....	39.99 kit
AAS-ALD-1	Spanner Only.....	28.99 ea.

No volume discount.

DSR-384



Shock Mounting Hardware

Correct GM rubber bushings, cup washer and nut for one shock.

DSR-384	1967-81 All Front.....	7.95 kit
---------	------------------------	----------

9-8101G



Energy Suspension Upper Shock Bushing

These polyurethane body bushings offer increased performance and longevity over stock.

Add G to the part number for black. Add R to part number for red. Example: 9-8101G is for 67-81 in black.

9-8101_	1967-81 All 4pc.....	4.99 kit
---------	----------------------	----------

BPX-9715



Shock Mounting Kit

Correct GM front shock mounting kit with (4) clips and (4) OEM bolts/washers.

BPX-9715	1967-81 All Front.....	6.95 kit
----------	------------------------	----------

DG-885



Shock Mounting Plates

Correct reproduction shock tower plates.

DG-724	1967-69 Bolt In.....	8.99 ea.
DG-885	1967-69 Weld In.....	13.99 ea.

DG-724

Shock Mounting Stud

Correct rear shock mounting stud.

DR-041	1967-81 Rear.....	8.95 ea.
--------	-------------------	----------



DR-041

NEW PRODUCT: QA1 SUSPENSION



QA1 Upper & Lower Tubular Control Arms

QA1's Street & Race Control Arms. The street arms use a factory replacement ball joint and polyurethane pivot bushings. These work great on vehicles used primarily for cruising and long distance events. The race arms utilize a QA1 Low Friction Ball Joint and low friction, low deflection pivot bushings, providing the added performance needed for drag racing, pro-touring and hardcore street applications. Configured for QA1 Pro Coil Systems, these control arms feature powder coated tubular construction for increased strength and great looks. A bolt-in spring adapter is available separately to allow the control arms to be used with stock springs. All of the upper arms feature an offset cross shaft letting you quickly and easily adjust camber. All of these arms are designed to add 3-4 degrees of caster and 0.5 to 1 degree of negative camber when used together. Includes mounting hardware. Made in the USA

Street Arms

QA1-52417	1967-69 All Upper	449.99 pr.
QA1-52419	1967-69 All Lower	629.99 pr.
QA1-52418	1970-81 All Upper	449.99 pr.
QA1-52420	1970-81 All Lower	629.99 pr.
QA1-52468	1982-92 All Lower	629.99 pr.

Race Arms

QA1-52317	1967-69 All Upper	549.99 pr.
QA1-52319	1967-69 All Lower	649.99 pr.
QA1-52318	1970-81 All Upper	549.99 pr.
QA1-52320	1970-81 All Lower	649.99 pr.
QA1-52368	1982-92 All Lower	649.99 pr.

No volume discount.



QA1-52418



QA1-52420



QA1-52816

QA1 Sway Bars

Give your chassis the stability it needs to keep your tires planted on the road. These sway bars are an easy bolt-on upgrade to help reduce body roll and handle corners better. For maximum strength and durability, QA1 sway bars are manufactured from either light-weight hollow-core (4130) chromoly steel or heavy duty solid-core (1045) cold formed steel. The bars are formed using precision CNC equipment for a true bolt-on installation, then gloss black powder coated for durability and corrosion resistance. Sway bars include new mounting components to replace old and worn out sway bar bushings and end links. Made in the USA.

QA1-52816	1967-69 All Front 1 1/4"	249.99 ea.
QA1-52893	1970-81 All Front 1 3/8"	259.99 ea.
QA1-52810	1982-92 All Front 1 3/8"	259.99 ea.
QA1-52874	1993-02 All Front 1 3/8"	259.99 ea.
QA1-52875	1982-02 All Rear 1	209.99 ea.
QA1-52812	1982-92 All Front&Rear 1 3/8"/1"	469.99 kit
QA1-52816	1993-02 All Front&Rear 1 3/8"/1"	249.99 ea.

No volume discount.



QA1-5204

QA1 Lower Rear Trailing Arms

QA1's Lower boxed trailing arms use polyurethane bushings on both ends, for a long-lasting finish, tubular and boxed trailer arms are powder coated gloss black, while the adjustable arms are zinc plated and anodized. These trailing arms have fluted, greaseable polyurethane bushings, which are superior to the stock rubber bushings. The relocation brackets lower the mounting point of the rear trailing arms. A must for lowered vehicles, they correct the trailing arm angle while raising the instant center of the vehicle, which improves forward bite and eliminates rear squat during hard acceleration. Two non-stock mounting locations are available in addition to the stock location, and they will accept QA1, OEM, or any other aftermarket lower trailing arms on the market. Made in the USA.

QA1-5204	1982-92 All Trailing Arms	269.99 pr.
QA1-5275	1982-92 All Trailing Arm Brackets.....	94.99 pr.

No volume discount.



QA1-5202

QA1-5222

QA1 Panhard Bars

QA1 Panhard Bars feature an improved design that resists unwanted flex and twisting, keeping the axle properly located under the chassis for improved cornering and drivability under all conditions. Adjustable Panhard Bars are needed for lowered cars to maintain proper axle alignment. Panhard bars include our fluted, greaseable graphite/polyurethane bushings for a long, trouble free life. Made in the USA.

QA1-5222	1982-02 All Adjustable.....	149.99 ea.
QA1-5202	1982-02 All Non-Adjustable.....	94.99 ea.

No volume discount.

QA1 Tie Rod Sleeves

These QA1 Heavy Duty Tie Rod Sleeves are manufactured from solid steel hex stock then zinc plated for durable good looks and corrosion resistance. These are stronger than stock OE split sleeves and easier to adjust. Made in the USA.



QA1-5251	1967-69 All.....	57.99 pr.
QA1-5252	1970-81 All.....	57.99 pr.
QA1-5250	1982-92 All.....	57.99 pr.

No volume discount.



QA1-52801

QA1 Adjustable Rear Toe Links

The QA1 Adjustable Rear Toe Links help keep tires planted firmly on the ground and pointed in the right direction to improve handling performance. They are constructed with aluminum adjustment sleeves, 5/8th inch heavy duty rod ends and urethane bushings for strength and stability. They replace OEM arms produced from stamped steel that can deform under hard cornering loads and use an eccentric for rear toe adjustment that is susceptible to slippage. The rod end on the QA1 Toe Links allow the suspension to operate smoothly throughout its full range of motion. The kit includes lockouts for the eccentrics to stop any movement of the rear toe adjustment and relocate the adjustment point onto the toe link for a finer and easier adjustment. Made in the USA.

QA1-52801	2010-11 SS Rear Toe Links.....	259.99 pr.
-----------	--------------------------------	------------

No volume discount.



QA1-5282

QA1 Torque Arms

QA1's Torque Arms feature strong tubular construction and a graphite/polyurethane front bushing to reduce wheel hop caused by excessive flex under hard accelerations and cornering. Adjustable Torque Arms are built from 1 inch x 0.120 inch wall tubing. The adjustable arm features a 3/4 inch spherical rod ends, allowing easy pinion angle adjustment. Powder coated black for durability with grade 8 bolts. Made in the USA. Fits vehicles with GM corporate 10-bolt rear ends in which front locator of stock torque arms has lips facing away from driveshaft.

QA1-5282	1982-02 All* Adjustable.....	329.99 ea.
QA1-5280	1982-02 All* Non-Adjustable.....	229.99 ea.

*Can be used on 1982-83 Camaro/Firebird with 1984 or newer mount. No volume discount.



QA1-DK02-GMF4

QA1 Drag Race Suspension Kits

Looking for a better launch, straight line stability and consistent performance? Turn to QA1's drag racing suspension kits for a full-vehicle upgrade that fits your needs. Available in two different levels of performance, these drag racing kits offer easy, bolt-in installation and seamlessly works with whatever OE component each piece attaches to.

Level 1 Includes: Front R series Stocker Star shocks, upper street control arms, lower street control arms, stock spring seat adapter, tie rod adjuster sleeves.

Level 2 Includes: Front Double Adjustable Pro Coil shock system, thrust bearing/spanner wrench kit, Upper race control arms, Lower race control arms, tie rod adjuster sleeves, ball joint tool kit. Available with and without shocks.

Level 1 Kits

QA1-DK01-GMF1	1967-69 w/ Shocks.....	1567.99 kit
QA1-DK11-GMF1	1967-69 w/o Shocks.....	1227.99 kit
QA1-DK01-GMF2	1970-81 w/ Shocks.....	1887.99 kit
QA1-DK11-GMF2	1970-81 w/o Shocks.....	1227.99 kit
QA1-DK01-GMF3	1982-92 w/ Shocks.....	1947.99 kit
QA1-DK11-GMF3	1982-92 w/o Shocks.....	1112.99 kit
QA1-DK01-GMF4	1993-02 w/ Shocks.....	1993.99 kit
QA1-DK11-GMF4	1993-02 w/o Sshocks.....	959.99 kit

Level 2 Kits

QA1-DK02-GMF1	1967-69 w/ Shocks.....	2042.99 kit
QA1-DK12-GMF1	1967-69 w/o Shocks.....	1287.99 kit
QA1-DK02-GMF2	1970-81 w/ Shocks.....	2503.99 kit
QA1-DK12-GMF2	1970-81 w/o Shocks.....	1287.99 kit
QA1-DK02-GMF3	1982-92 w/ Shocks.....	3794.99 kit
QA1-DK12-GMF3	1982-92 w/o Shocks.....	1792.99 kit
QA1-DK02-GMF4	1993-02 w/ Shocks.....	2597.99 kit
QA1-DK12-GMF4	1993-02 w/o Shocks.....	1054.99 kit

No volume discount.

NEW PRODUCT: QA1 SUSPENSION (CONTINUED)

QA1 Performance Handling Kits

Want better handling? Turn to QA1's handling suspension kits for the best ride that fits your needs. Available in three different levels of performance, these handling kits offer easy, bolt-in installation and seamlessly works with whatever OE component each piece attaches to. You can build your car in stages using our parts list as a road map to get to the level of performance you want and have the peace of mind knowing you won't have compatibility issues.



QA1-HK12-GMF3

1967-81 Kits

Level 1 Includes: Front non-adjustable Stocker Star shocks, front sway bar, tie rod adjuster sleeves.

- QA1-DK01-GMF1 1967-69 w/ Shocks.....1567.99 kit
- QA1-DK01-GMF2 1970-81 w/ Shocks.....1887.99 kit

Level 2 Includes: Front single adjustable Pro coil shock system, front sway bar, thrust bearing/spanner wrench kit, upper street control arms, lower street control arms, tie rod adjuster sleeves.

- QA1-DK02-GMF1 1967-69 w/ Shocks.....2042.99 kit
- QA1-DK12-GMF1 1967-69 w/o Shocks.....1287.99 kit
- QA1-DK02-GMF2 1970-81 w/ Shocks.....2503.99 kit
- QA1-DK12-GMF2 1970-81 w/o Shocks.....1287.99 kit

Level 3 Includes: Front double adjustable Pro coil shock system, front sway bar, thrust bearing/spanner wrench kit, upper race control arms, lower race control arms, tie rod adjuster sleeves, ball joint tool kit.

- QA1-HK03-GMF1 1967-69 w/ Shocks.....2292.99 kit
- QA1-HK13-GMF1 1967-69 w/o Shocks.....1537.99 kit
- QA1-HK03-GMF2 1970-81 w/ Shocks.....2763.99 kit
- QA1-HK13-GMF2 1970-81 w/o Shocks.....1547.99 kit

1982-02 Kits

Level 1 Includes: Front single adjustable Stocker Star struts, rear single adjustable Stocker Star shocks, front & rear sway bars, tie rod adjuster sleeves, boxed rear lower trailing arms, tubular panhard bar, non adjustable torque arm.

- QA1-HK01-GMF3 1982-92 w/ Shocks.....1917.99 kit
- QA1-HK11-GMF3 1982-92 w/o Shocks.....1122.99 kit
- QA1-DK11-GMF4 1993-02 w/ Shocks.....959.99 kit

Level 2 Includes: Front single adjustable Stocker Star struts, rear single adjustable Stocker Star shocks, caster camber plates, thrust bearing/spanner wrench kit, front & rear sway bars, tie rod adjuster sleeves, lower front street control arms, boxed rear lower trailing arms, trailing arm relocation brackets, tubular panhard bar, non adjustable torque arm.

- QA1-HK02-GMF3 1982-92 w/ Shocks.....3524.99 kit
- QA1-HK12-GMF3 1982-92 w/o Shocks.....1902.99 kit
- QA1-HK02-GMF4 1993-02 w/ Shocks.....2287.99 kit
- QA1-HK12-GMF4 1993-02 w/o Shocks.....1064.99 kit

Level 3 Includes: Front double adjustable pro-coil struts, rear double adjustable pro-coil shocks, caster camber plates, thrust bearing/spanner wrench kit, front & rear sway bars, tie rod adjuster sleeves, lower front race control arms, boxed rear lower trailing arms, trailing arm relocation brackets, tubular adjustable panhard bar, adjustable torque arm, ball joint tool kit.

- QA1-HK03-GMF3 1982-92 w/ Shocks.....4054.99 kit
- QA1-HK13-GMF3 1982-92 w/o Shocks.....2052.99 kit
- QA1-HK03-GMF4 1993-02 w/ Shocks.....2857.99 kit
- QA1-HK13-GMF4 1993-02 w/o Shocks.....1314.99 kit

No volume discount for all.

QA1 Front Coilover Shock Kits

The QA1 Pro Coil System is a great option for anyone looking for fully adjustable ride height and valving control. Choose a spring rate and adjustability that fits your driving style, adjust the valving to match and you are on your way. These shocks also utilize a fully threaded body that allows you to adjust your ride height for the perfect stance or to finely tune the weight balance for superior handling. Specially designed for QA1's Pro Coil Systems, the American-made lightweight high travel springs have fewer coils and a smaller wire diameter, resulting in increased travel due to the larger distance between the coils. They reduce unsprung weight and react faster, optimizing suspension performance. Adjustable Pro Coil System Features: Available in MOD Series, independent compression and rebound double adjustable, simultaneous compression and rebound adjustable, or Drag R Series adjustable. Lightweight Billet Aluminum Coilover Shocks High Travel Springs Easy, Bolt-In Installation Ride Height Adjustable, Made in the USA
SA = single adjustable DA = double adjustable
DR = drag series adjustable MO = mod series



QA1-GS401-10400A

QA1-GD501-10550C

Small Block Included spring rate: 400 Lbs, ideal for front axle weight between 1801-1900 Lbs.

- QA1-GS401-10400A 1967-69 SA.....545.99 kit
- QA1-GD401-10400A 1967-69 DA.....705.99 kit
- QA1-GR401-10400A 1967-69 DR.....605.99 kit
- QA1-MG401-10400A 1967-69 MO.....1525.99 kit

Big Block Included spring rate: 500 Lbs, ideal for front axle weight between 2001-2100 Lbs.

- QA1-GS401-10500A 1967-69 SA.....545.99 kit
- QA1-GD401-10500A 1967-69 DA.....705.99 kit
- QA1-GR401-10500A 1967-69 DR.....605.99 kit
- QA1-MG401-10500A 1967-69 MO.....1525.99 kit

Small Block Included spring rate: 450 Lbs, ideal for front axle weight between 1901-2000 Lbs.

- QA1-GS501-10450C 1970-81 SA.....545.99 kit
- QA1-GD501-10450C 1970-81 DA.....705.99 kit
- QA1-GR501-10450C 1970-81 DR.....605.99 kit
- QA1-MG501-10450C 1970-81 MO.....1525.99 kit

Big Block Included spring rate: 550 Lbs, ideal for front axle weight between 2101-2200 Lbs.

- QA1-GS501-10550C 1970-81 SA.....545.99 kit
- QA1-GD501-10550C 1970-81 DA.....705.99 kit
- QA1-GR501-10550C 1970-81 DR.....605.99 kit
- QA1-MG501-10550C 1970-81 MO.....1525.99 kit

Street Included spring rate: 250 Lbs, ideal for nice ride & handling.

- QA1-HS606S-12250 1982-92 SA.....719.99 kit
- QA1-HD606S-12250 1982-92 DA.....939.99 kit
- QA1-HR606S-12250 1982-92 DR.....759.99 kit

Track Included spring rate: 325 Lbs, ideal for firm ride with great cornering.

- QA1-HS606S-12325 1982-92 SA.....719.99 kit
- QA1-HD606S-12325 1982-92 DA.....939.99 kit
- QA1-HR606S-12325 1982-92 DR.....759.99 kit

Street Included spring rate: 300 Lbs, ideal for nice ride & handling.

- QA1-GS502-15300 1993-02 SA.....545.99 kit
- QA1-GD502-15300 1993-02 DA.....705.99 kit
- QA1-GR502-15300 1993-02 DR.....605.99 kit

Track Included spring rate: 325 Lbs, ideal for firm ride with great cornering.

- QA1-GS502-15325 1993-02 SA.....545.99 kit
- QA1-GD502-15325 1993-02 DA.....705.99 kit
- QA1-GR502-15325 1993-02 DR.....605.99 kit

No volume discount.



QA1-TN505

QA1-TN802

QA1 Stocker Star Shocks

These stock mount adjustable front & rear shocks are available for your Camaro. Available in double, single, Drag R Series and non-adjustable options, these shocks provide exactly the ride you want, high performance handling and great looks. These QA1 aluminum shocks are 100% dyno tested and serialized before leaving our factory. Made in the USA. Easy, bolt-in installation.

NA = non-adjustable SA = single adjustable
DA = double adjustable DR = drag series adjustable

- QA1-TN505 1967-69 Front NA114.99 ea.
- QA1-TS505 1967-69 Front SA159.99 ea.
- QA1-TD505 1967-69 Front DA239.99 ea.
- QA1-TR505 1967-69 Front DR169.99 ea.
- QA1-TN507 1970-81 Front NA114.99 ea.
- QA1-TS507 1970-81 Front SA159.99 ea.
- QA1-TD507 1970-81 Front DA239.99 ea.
- QA1-TR507 1970-81 Front DR169.99 ea.
- QA1-TN802 1967-69 Rear NA Multi Leaf114.99 ea.
- QA1-TS802 1967-69 Rear SA Multi Leaf159.99 ea.
- QA1-TS802 1967-69 Rear DA Multi Leaf159.99 ea.
- QA1-TN703 1967-69 Rear NA Mono Leaf114.99 ea.
- QA1-TS703 1967-69 Rear SA Mono Leaf159.99 ea.
- QA1-TS703 1967-69 Rear DA Mono Leaf159.99 ea.
- QA1-TN702 1970-81 Rear NA Multi Leaf114.99 ea.
- QA1-TS702 1970-81 Rear SA Multi Leaf159.99 ea.
- QA1-TS702 1970-81 Rear DA Multi Leaf159.99 ea.
- QA1-TN704 1982-02 Rear NA Multi Leaf114.99 ea.
- QA1-TS704 1982-02 Rear SA Multi Leaf159.99 ea.
- QA1-TS704 1982-02 Rear DA Multi Leaf159.99 ea.

No volume discount.

QA1-RCK52327



QA1 Rear Coilover Shock Kits

QA1 bolt-in rear coil-over conversion kits. These kits include specially designed USA made mounting brackets, single, double or MOD Series adjustable aluminum shocks specific to 3rd and 4th Generation F-Bodies, springs and all necessary hardware. Single adjustable shocks provide 18 positions of simultaneous rebound and compression adjustment while QA1's double adjustable shocks provide 18 positions of compression adjustment and 18 positions of rebound adjustment, for a total of 324 possible valving combinations. MOD Series shocks also feature a double adjustable design but include adjustable low-speed bleed as well for fully independent control over compression and rebound characteristics. These shocks also utilize a fully threaded body allowing for ride height adjustability. Multiple spring rate options are also available, and have been successfully tested in various applications, from casual street driving to hardcore race applications. With our highly popular adjustable struts and the addition of the rear coilover conversion kit, you can now get a complete suspension makeover for both ends of the vehicle. Bolt-In installation. Made in the USA.
SA = single adjustable DA = double adjustable
DR = drag series adjustable MO = mod series

Included spring rate: 110 Lbs, ideal for soft ride feel.

- QA1-RCK52327 1982-92 SA613.99 kit
- QA1-RCK52331 1982-92 DA773.99 kit

Included spring rate: 130 Lbs, ideal for medium ride feel.

- QA1-RCK52328 1982-92 SA613.99 kit
- QA1-RCK52332 1982-92 DA773.99 kit

Included spring rate: 150 Lbs, ideal for firm ride feel.

- QA1-RCK52329 1982-92 SA613.99 kit
- QA1-RCK52333 1982-92 DA773.99 kit

No volume discount.



UMI-266501-B



UMI Corner Max Kit, Race & Street Handling

UMI's Corner Max front end kits for 1970-1981 Camaro are a comprehensive system with our best corner carving parts under one easy to find part number. The Corner Max system combines geometry corrected a-arms with tall ball joints, higher rate springs, UMI rebound adjustable monotube shocks, heavy duty sway bar and a bump steer kit. The foundation of the kit includes our coilover-only lower a-arms featuring caster improvement, tall ball joints and the ability to remove the spring and shock without taking the spindle apart. The upper a-arm features rod ends for smooth operation and the ability to adjust without shims. The 1-5/16th inch sway bar upgrade complete with UMI's fabricated end links reduces body roll and helps speed transitions. Racing coilover springs are paired with UMI's rebound adjustable coilover monotube shocks. Fine-tuning is accomplished with a UMI bump steer kit. The Corner Max kit is built to make the stock GM clip work as well as it possibly can with a true bolt-on kit. All UMI Performance parts are fabricated and raced with pride out of Philipsburg, PA - USA.

UMI-266501-B	1970-81 Black	2599.99 kit
UMI-266501-R	1970-81 Red	2599.99 kit



DFB-13L

Leaf Spring Mounting Brackets

Correct brackets for mounting the front of the leaf spring to the body.

DFB-13L	1967-69 LH	34.95 ea.
DFB-13R	1967-69 RH	34.95 ea.
DFB-13K	1967-69 LH/RH	75.80 kit
DFB-16L	1970-81 LH	36.95 ea.
DFB-16R	1970-81 RH	36.95 ea.
DFB-16K	1970-81 LH/RH	79.00 kit

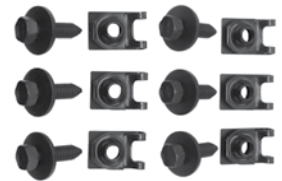

BLS-1130

Front Leaf Spring Bracket Hardware Kit

Correct bolts and special clips for mounting front leaf spring brackets to car. This kit includes (6) OEM bolts and (6) J nuts.

BLS-1130	1967-81 All	16.95 kit
----------	-------------------	-----------

LEAF SPRINGS



DTR-7412

Replacement Leaf Springs

These are excellent OEM replacement leaf springs which will restore the proper rear ride height.

DTR-7910	1967-69 Mono Leaf	281.99 pr.
DTR-7412	1967-81 4 Leaf.....	199.95 pr.
DTR-7815	1967-81 5 Leaf.....	179.95 pr.

No Volume Discount. Ships Oversize 2.



DLK-67-SK

Leaf Spring Mounting Super Kit

This kit has everything you need to install your leaf springs. The kit includes spring pads, front eye bolts, front mounting bracket hardware, complete rear shackles, U-bolts and T-bolts.

DLK-67-SK	1967-69 Mono	134.56 kit
DLK-69M-SK	1967-69 Multi.....	118.64 kit
DLK-70M-SK	1970-81 Multi.....	125.04 kit

No volume Discount.



DLK-69M

Leaf Spring Mounting Kit

This kit comes complete with (4) correct pads, (2) U-bolts and (4) T bolts with (8) nuts. Does one car.

DLK-67	1967-69 Mono.....	54.00 kit
DLK-69M	1967-69 Multi.....	50.80 kit
DLK-70M	1970-81 Multi.....	54.00 kit



DTR-4RBK

Leaf Spring Rebuild Kits

Includes the correct hardware to disassemble the leaf springs and put them back together like new.

DTR-4RBK	1967-81 4 Leaf.....	36.95 kit
DTR-5RBK	1967-81 5 Leaf.....	41.95 kit



DSB-99

Leaf Spring Eye Bushing

Correct front eye bushing.

DSB-99	1967-81 All	19.95 ea.
--------	-------------------	-----------



BBB-2743

Front Leaf Spring Eye Bolt

Correct OEM bolt with washers and special nut for mounting front leaf spring to car. 2 required.

BBB-2743	1967-81 All	3.95 ea.
----------	-------------------	----------



BPB-4829

U Bolt

Correct U bolt & nuts for multi leaf springs.

BPB-4829	U Bolt	5.95 ea.
----------	--------------	----------



BPB-2949

T Bolt

Correct T bolt & nut for mono leaf springs.

BPB-2949	T Bolt	6.95 ea.
----------	--------------	----------



Leaf Spring Pads

Correct rubber pads for mounting springs.

DTE-7818	1967-69 Mono.....	6.95 ea.
DTE-67	1967-69 Multi.....	5.95 ea.
DTE-70U	1970-81 Upper.....	7.95 ea.
DTE-70L	1970-81 Lower.....	7.95 ea.



Performance POLYURETHANE Components



3-3112G

Energy Suspension Leaf Spring Pads

Be in control of your suspension while you're maneuvering through turns, doing drag-style launches and braking.

Add G to the part number for black. Add R to part number for red. Example. 3-2134G is for 67-81 in black.

3-6112_	1967-69 Multi.....	27.99 kit
3-6113_	1967-69 Mono.....	24.99 kit
3-6111_	1970-81 Multi.....	28.99 kit



NJX-283

Leaf Spring Plates

Correct lower leaf spring mounting plates.

NXJ-7L	1967 Mono LH.....	44.95 ea.
NXJ-7R	1967 Mono RH.....	44.95 ea.
NXJ-7R	1968-69 Mono LH = RH.....	44.95 ea.
NXJ-283	1968-69 Multi LH = RH.....	42.95 ea.
NXJ-285	1970-81 Multi LH = RH.....	42.95 ea.



DSP-500

Leaf Spring Perch

Correct leaf spring perches for rear axle.

DSP-500	1967-69 Multi.....	69.95 pr.
DSP-501	1967-69 Mono.....	69.95 pr.



NRD-0045

Leaf Spring Rear Shackle Kit

OE style reproduction shackle kit complete with plates, bushings, bolts and nuts. Does 1 car.

NRD-0045	1967-70 All.....	59.95 kit
NRD-0050	1971-81 All.....	59.95 kit



Rear Shackle Bushings

DSB-8R

OE style reproduction rear shackle bushings.

DSB-8R	1967-69 All.....	32.95 kit
DSB-70	1970-81 All.....	44.99 kit



Performance POLYURETHANE Components

3-2136G



Energy Suspension Rear Shackle Kits

Be in control of your suspension while you're maneuvering through turns, doing drag-style launches and braking.

Add G to the part number for black. Add R to part number for red. Example. 3-2134G is for 67-81 in black.

3-2134_	1967-81 Multi.....	125.99 kit
3-2136_	1967-69 Mono.....	125.99 kit

Bushings only

3-2103_	1970-81 Multi.....	70.99 kit
3-2101_	1967-69 Mono.....	70.99 kit



DSE041101



Mono-to-Multi Leaf Conversion Kit

Use this kit to convert your original mono-leaf spring to multi-leaf spring configuration. Kit includes: U-bolts, a hardcoated steel locating pad, aluminum spacers, washers & nuts.

DSE041101	1967-69.....	104.99 kit
-----------	--------------	------------



SSM-1304



SSM-1319

Southside Machine Lower Traction Lift Bars

SouthSide Machine lift bars use the axle torque to increase your tire traction by lowering the center of gravity on the rear axle. This forces torque downward instead of forward, planting your rear tires by pushing them down into the pavement. This greatly reduces wheel spin and eliminates axle-hop. If you're not using these classic SSM lift bars, you'll just be spinning your wheels!

SSM-1304	1967-69.....	199.95 pr.
SSM-1319	1970-81.....	199.95 pr.

No volume discount.

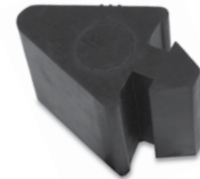

DAB-6X

Rear End Pinion Bumper

Excellent reproduction of the often missing or damaged rear pinion bumper which is required to keep the pinion housing from contacting the floor.

DAB-6X	1967-69.....	14.95 ea.
--------	--------------	-----------



DAB-202



DAB-083L

Axle Housing Bumpers

Excellent reproduction of the often missing or damaged axle housing bumper.

DAB-202	1967.....	21.95 ea.
DAB-083L	1968-69 LH.....	27.95 ea.
DAB-083R	1968-69 RH.....	27.95 ea.
DAB-088	1970-81.....	21.95 ea.



DAA-136

Front Sway Bar Kit

Eliminate poor handling by installing one of these sway bars! It includes sway bar, brackets, bushings and end links to replace your old, small bar.

- | | | |
|------------|-------------------------------------|------------|
| DAA-136 | 1967-69 All 1" | 184.99 kit |
| DAA-599 | 1967-69 All 1-1/8" HD | 197.99 kit |
| DAA-1516-Z | 1967-69* 13/16" Big Block/ Z/28.... | 169.95 ea. |
| DAA-8A | 1970-81 1-1/4" (bar only)..... | 159.95 ea. |
- No Volume Discount. Ships Oversize 2.
*All with SHP engines with balancer.



DSB-5814

Rear Sway Bar Kit

This complete direct OEM replacement rear sway bar kit comes complete and ready to install with all brackets, bushings, hardware and sway bar. While not technically correct, this sway bar will fit and function as original and is excellent for street, strip, road racing and everything in between!

- | | | |
|----------|----------------------------|------------|
| DSB-5814 | 1967-69 All 7/8" Bar | 175.99 kit |
| DSB-6774 | 1967-69 All 1" Bar | 181.99 kit |
| DSB-81 | 1970-81 All 1" Bar | 199.99 kit |
- Ships Oversized. No volume discount.*



DBB-6769K

Sway Bar Bushing & Brackets Kit

Correct mounting brackets, bolts and bushings for the front sway bar.

- | | | |
|-----------|-------------------------|-----------|
| DBB-6769K | 1967-69 1" Bar | 49.95 kit |
| MK52-KIT | 1970-81 1-1/4" Bar..... | 22.95 kit |

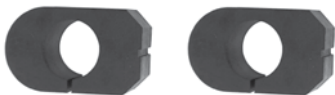

DMG-683

Sway Bar Bushings

Correct bushings for the sway bar.

- | | | |
|---------|-----------------------------|-----------|
| DHB-69 | All with 1-1/16" Bars | 12.95 pr. |
| DCI-679 | 13/16", 1-1/16" Bars*..... | 9.95 pr. |
| DMG-647 | 13/16", 1" Bars* | 12.95 pr. |
| DMG-683 | 1 1/16", 1-1/8" Bars*..... | 11.95 pr. |
| DMG-81R | 1970-81 Rear..... | 13.99 pr. |
- *Use DBB-157 bracket.



DBB-655

DBB-656

Sway Bar Sleeve Bracket

These mount on the front sway bar next to the sway bar bracket and mount to the frame. They keep the sway bar from moving side to side.

- | | | |
|---------|-------------------------|-----------|
| DBB-655 | 1967-74 All | 21.99 pr. |
| DBB-656 | 1967-74 All Bolts | 6.95 set |



3-5202G



Energy Suspension Sway Bar Bushings

These polyurethane body bushings offer increased performance and longevity over stock.

Add G to the part number for black. Add R to part number for red. Example. 3-5202G is for 67-69 in black.

- | | | |
|---------|-------------------------|-----------|
| 3-5202_ | 1967-69 11/16" Bar..... | 22.99 pr. |
| 3-5203_ | 1967-69 13/16" Bar..... | 22.99 pr. |
| 9-5164_ | 1970-81 1-1/8" Bar..... | 20.99 pr. |
| 9-5165_ | 1970-81 1-1/4" Bar..... | 20.99 pr. |



DBB-157

DBB-81R

Sway Bar Brackets

Correct mounting brackets for the sway bar.

- | | | |
|----------|-----------------------------------|-----------|
| DBB-157 | 1967-81 1-1/16", 1 1/8" Bars..... | 7.95 ea. |
| 14073310 | 1968-81 1-1/4" Bar..... | 11.95 ea. |
| DBB-81R | 1970-81 Rear | 16.99 ea. |
| BAR-1295 | 1967-81 All Bolt..... | 0.75 ea. |



ES-681

Stabilizer End Links

Complete kit for one car.

- | | | |
|--------|-------------------|-----------|
| DSL-90 | 1967-81 All | 14.95 kit |
|--------|-------------------|-----------|



9-8125G

Energy Suspension Sway Bar End Links

These Polyplus sway bar end links will improve handling and steering response.

Add G to the part number for black. Add R to part number for red. Example. 3-2134G is for 67-81 in black.

- | | | |
|---------|---------------|-----------|
| 9-8125_ | 1967-81 | 20.99 pr. |
|---------|---------------|-----------|



FA-487

FA-487

Ball Joints

- | | | |
|--------|------------------------|-----------|
| FA-487 | 1967-69 All Upper..... | 22.95 ea. |
| FA-688 | 1970-81 All Upper..... | 26.95 ea. |
| FA-993 | 1967-69 All Lower..... | 22.95 ea. |
| FA-291 | 1970-81 All Lower..... | 26.95 ea. |



ES-350

Adjustment Sleeves

OEM style adjustment sleeve for proper adjustment of tie rods.

- | | | |
|---------|--------------------|-----------|
| ES-350 | 1967-69 LH/RH..... | 14.95 ea. |
| ES-2004 | 1970-81 LH/RH..... | 14.95 ea. |



ES-381

Outer Tie Rods

Correct OEM cast steel outer tie rods. The highest quality original style suspension products on the market! Fits LH or RH.

- | | | |
|----------|---------------|-----------|
| ES-381 | 1967-69..... | 29.95 ea. |
| ES-404 | 1970-74 | 62.95 ea. |
| ES-441RL | 1975-81 | 29.95 ea. |



DS-829

Center Drag Links

- | | | |
|---------|-------------------------------|-----------|
| DK-0142 | 1967-69 All | 95.99 ea. |
| DS-829 | 1970-81 All V8 with P/S | 79.95 ea. |

No Volume Discount



ES-681

Inner Tie Rods

Correct OEM cast steel inner tie rods.

- | | | |
|---------|--------------------|-----------|
| ES-681 | 1967-69 LH/RH..... | 29.95 ea. |
| ES-781 | 1970-74 RH | 65.00 ea. |
| ES-782 | 1970-74 LH..... | 65.00 ea. |
| ES-442L | 1975-81 LH..... | 34.95 ea. |
| ES-443L | 1975-81 RH | 34.95 ea. |



BPX-9873

D-18718

Idler Arms

- | | | |
|----------|-------------------|-----------|
| D-18718 | 1967-69 All | 39.95 ea. |
| D-5212 | 1970-81 All | 52.95 ea. |
| BPX-9873 | Bolts..... | 3.95 pr. |



UMI-2660



UMI Tie Rod Adjusters

These Camaro tie rod adjusters from UMI Performance are designed to eliminate the factory clamp style design making adjustments easy and hassle free while adding enhanced steering. CNC machined from solid mild steel hex and feature left and right hand threads for easy on-car adjustments then finished in a durable black powder coat. These tie rod adjusters work with the factory tie rod ends with no modifications.

UMI-2102	1967-69	54.99 kit
UMI-2102HD	1967-69 Heavy Duty	64.99 kit

No Volume Discount.



UMI-2660

UMI Bump Steer Adjuster Set

UMI's Camaro bump steer kit is designed to reduce or eliminate toe change during suspension travel (also known as bump steer). Reduction of bump steer improves handling and straight line stability and enhances overall precision of the steering system.



UMI-2660	1972-81	Street Black	189.99 kit
UMI-2660-1	1972-81	Race Black	189.99 kit
UMI-3060	1982-92	Street Black	189.99 kit
UMI-3060-1	1982-92	Race Black	189.99 kit
UMI-2060-1	1993-02	Race Black	289.99 kit

No volume discount.

UMI Upper & Lower Tubular A-Arms

Improve the street and track performance of your F-body and achieve that precise Pro-Touring feel by adding a set of fabricated tubular A-Arms. The stock geometry lower a-arms, which work with most popular springs and coilovers, feature tough tubular construction with greaseable polyurethane bushings for precise handling and smooth suspension motion. Optional Delrin® bushings offer additional precision and decreased friction. The ball joint mount is angled slightly from stock to permit usage with lowered vehicles and the design offers additional wheel clearance. The tubular upper a-arms feature Delrin® bushings as well as billet chromoly cross shafts. The relocated ball joint mounting pad increases caster, steering feel and stability without excessive shims and can be loaded with 1/2" taller upper ball joints to improve camber performance. The ultra tough red or black powder coat finish guarantees your performance parts stay beautiful on your street car, drag car, auto crosser or Pro-Touring machine. For the best handling and tire life from UMI designed a-arms, included with each kit are recommended alignment specs along with detailed installation instructions.

1970-1981 Control Arms

Insert color choice in ___ R = Red B = Black

Upper A-Arms w/ Delrin® Bushings

UMI-2653-__	1970-81 Standard Ball Joints	519.99 pr.
UMI-2653-1-__	1970-81 1/2" Taller Ball Joints	599.99 pr.

Upper A-Arms w/ Adjustable Bushings

UMI-2656-__	1970-81 Standard Ball Joints	519.99 pr.
UMI-2656-1-__	1970-81 1/2" Taller Ball Joints	599.99 pr.

Lower A-Arms w/ Polyurethane Bushings

UMI-2651-__	1970-81 Standard Ball Joints	629.99 pr.
-------------	------------------------------	------------

Lower A-Arms w/ Delrin® Bushings

UMI-2652-__	1970-81 Standard Ball Joints	699.99 pr.
-------------	------------------------------	------------

Kit: Upper A-Arms w/ Delrin® Bushings, Lower A-Arms w/ Polyurethane Bushings

UMI-265153-__	1970-81 Standard Ball Joints	1149.99 kit
---------------	------------------------------	-------------

Kit: Upper A-Arms w/ Delrin® Bushings, Lower A-Arms w/ Delrin® Bushings

UMI-265253-1-__	1970-81 1/2" Taller Ball Joints	1299.99 kit
-----------------	---------------------------------	-------------

Kit: Upper A-Arms w/ Adjustable Bushings, Lower A-Arms w/ Delrin® Bushings

UMI-265256-1-__	1970-81 1/2" Taller Ball Joints	1299.99 kit
-----------------	---------------------------------	-------------

1982-1992 Control Arms

Insert color choice in ___ R = Red B = Black

Lower A-Arms w/ Delrin® Bushings

UMI-3032-__	1982-92 Standard Ball Joints Factory Struts	699.99 pr.
UMI-2052-__	1982-92 Standard Ball Joints Coilover Shocks	569.95 pr.

Lower A-Arms w/ Polyurethane Bushings

UMI-3031-__	1982-92 Standard Ball Joints Factory Struts	629.99 pr.
UMI-2051-__	1982-92 Standard Ball Joints Coilover Shocks	489.95 pr.

Hardware

UMI-2601	1970-81 Upper Control Arm Bolts	11.95 kit
UMI-4001	1970-74 Lower Control Arm Bolts	13.95 kit
UMI-1003	1975-81 Lower Control Arm Bolts	14.99 kit
UMI-3011	1982-92 Lower Control Arm Bolts	12.95 kit
UMI-2302	1993-02 Upper Control Arm Bolts	10.95 kit
UMI-2301	1993-02 Lower Control Arm Bolts	15.99 kit

Tall Ball Joint Option: UMI is proud to offer a number of tall ball joint options. In addition to standard height ball joints, we offer 0.5" tall uppers. Additional ball joint height functions the same as adding a taller spindle at a fraction of the cost. Drag and cruising oriented cars work fine with standard height while tall ball joints optimize cornering ability. No Volume Discount. Not eligible for free shipping.



UMI-2653-R



UMI-2651-B

1993-2002 Control Arms

Insert color choice in ___ R = Red B = Black



Upper A-Arms w/ Adjustable Bushings

UMI-2310-__	1993-02 Standard Ball Joints	409.95 kit
-------------	------------------------------	------------

Upper A-Arms w/ Polyurethane Bushings

UMI-2311-__	1993-02 Standard Ball Joints	269.95 kit
-------------	------------------------------	------------

Lower A-Arms w/ Adjustable Rod Ends For Drag Racing

UMI-2300-__	1993-02 Adjustable Race w/ Rod Ends	499.95 kit
UMI-2317-__	1993-02 Adjustable Race w/ Rod Ends Chromoly*	549.95 pr.

*Heavy duty material.

Lower A-Arms w/ Polyurethane Bushings

UMI-2305-__	1993-02 Non Adjustable Street w/ Rod End	499.95 kit
UMI-2306-__	1993-02 Non Adjustable Street w/ Roto-Joint	549.95 kit

Lower A-Arms w/ Delrin® Bushings

UMI-2307-__	1993-02 Non Adjustable Street w/ Rod End	529.95 kit
UMI-2308-__	1993-02 Non Adjustable Street w/ Roto-Joint	569.95 kit

Lower A-Arms w/ Roto-Joint Bushings

UMI-2304-__	1993-02 Non Adjustable Street w/ Roto-Joint Both Ends	599.95 kit
-------------	---	------------

Kit: Upper A-Arms w/ Polyurethane Bushings,

Lower A-Arms w/ Polyurethane Bushing and Rod End		
UMI-230511-__	1993-02 Standard Ball Joints	769.95 kit

Kit: Upper A-Arms w/ Polyurethane Bushings,

Lower A-Arms w/ Adjustable Rod Ends Budget Drag Race		
UMI-230011-__	1993-02 Standard Ball Joints	769.95 kit

Kit: Upper A-Arms w/ Adjustable Rod Ends, Lower A-Arms w/ Adjustable Rod Ends Drag Race

UMI-230010-__	1993-02 Standard Ball Joints	909.95 kit
---------------	------------------------------	------------

*Heavy duty material.



UMI-2112-R



UMI-2245-325-R

UMI-90048

UMI Solid Sway Bars

UMI Performance solid sway bars are designed to reduce body roll, understeer and increase cornering capabilities resulting in a more balanced suspension. UMI Performance sway bars are manufactured from 4140 chrome moly steel and formed as one piece to ensure maximum strength and performance. The rear sway bar is heat treated to maintain longer memory than a cold bent sway bar. The front sway bar is CNC bent for a precision fit. Kit is available powdercoated bright red or gloss black for a durable long lasting finish.

Insert color choice in ___ R = Red B = Black

UMI-4035-__	1970-81 Front Only 1-1/4"	209.99 kit
UMI-2112-__	1982-02 Front Only 1-3/8"	229.99 kit
UMI-2245-275-__	1982-02 Rear Only 1-1/4"	429.95 kit
UMI-2245-300-__	1982-02 Rear* Only 1-1/4"	429.95 kit
UMI-2245-325-__	1982-02 Rear** Only 1-1/4"	429.95 kit
UMI-211213-__	1982-02 Front/Rear	429.99 kit
UMI-2113-__	2010-11 Rear Only 1-1/4"	199.95 kit
UMI-90048	1970-02 Billet Mounts Front Only 1-3/8" Bar	129.95 pr.

* Fits drag race cars with 3" axle tubes only. ** Fits drag race cars with 3-1/4" axle tubes only. No Volume Discount. Ships Oversize 2. Not eligible for free shipping.



UMI-2004-R

UMI Subframe Connectors

Subframe connectors improve your car's handling ability while reducing t-top squeaks, dash rattles and quarter panel flexing, designed for auto-cross, road race as well as drag race set-ups.

By connecting the front and rear subframes together this allows better weight transfer for improved traction and straighter launches. Insert color choice in ___ R = Red B = Black

2 Point Kits

UMI-2002-__	1993-02 Bolt In Tubular Coupe	239.95 pr.
UMI-2027-__	1993-02 Bolt In Tubular CVT	239.95 pr.
UMI-2001-__	1993-02 Weld In Tubular Coupe	169.95 pr.
UMI-2026-__	1993-02 Weld In Tubular CVT	239.95 pr.
UMI-2000-__	1993-02 Weld In Boxed	219.95 pr.

3 Point Kits

UMI-2004-__	1993-02 Bolt In Tubular Coupe	519.95 pr.
UMI-2044-__	1993-02 Bolt In Tubular CVT	519.95 pr.
UMI-2003-__	1993-02 Weld In Tubular Coupe	499.95 pr.
UMI-2043-__	1993-02 Weld In Tubular CVT	499.95 pr.

No Volume Discount. Ships Oversize 2. Not eligible for free shipping.



UMI-2225-B

UMI Transmission Crossmembers

These transmission crossmembers are designed to bolt a TH350 or TH400 automatic transmission into a 1993-2002 Camaro. This crossmember is 100% bolt in and requires no drilling, no cutting and no welding. It bolts in place of the factory transmission crossmember using the existing holes. Insert color choice in ___ R = Red B = Black

UMI-2225-__	1993-97 w/ TH350	169.95 ea.
UMI-2223-__	1993-97 w/ TH400	179.95 ea.
UMI-2211-__	1998-02 w/ TH350	179.95 ea.
UMI-2222-__	1998-02 w/ TH400	179.95 ea.

No Volume Discount. Ships Oversize 2. Not eligible for free shipping.



UMI-2500-R

UMI Driveshaft Tunnel Brace

The UMI heavy duty tunnel brace reinforces the tunnel area and reduces chassis flex by replacing the weak factory stamped steel brace. Reinforcement of this area is critical because of the drive shaft carrier bearing location. The UMI tunnel brace is fabricated from CNC machined 3/16" thick mounting plates, rectangular tubing and MIG welded. The tunnel brace is a 100% bolt in application and uses existing factory mounting holes. Installation requires basic hand tools and can be completed in less than a half hour.

UMI-2500-R	2010-13 Red	89.95 ea.
UMI-2500-B	2010-13 Black	89.95 ea.

No Volume Discount.

UMI Front Crossmember

The UMI Performance tubular K-Member instantly removes up to 25 lbs. from the front of your vehicle while still maintaining strength for streetability and daily use. This item has been designed to handle everything from drag racing, daily driving and even autocross. Our dual tube center section adds increased strength over the competitors' design, making this item far more superior and able to handle every day stress and abuse. Additional front end adjustment can also be achieved with this item, the lower A-Arm slots feature a 1/2 inch adjustment built in and will work with the stock and any aftermarket A-Arm set-up. The front and rear A-Arm slots also feature additional bracing to withstand hard side loads and extreme pressure. This tubular K-Member also features integrated motor mounts eliminating the stock cast iron mounts and for maximum weight savings. Combine this with a set of our lower control arms and expect a weight reduction of up to 33 lbs. Insert color choice in ___ R = Red B = Black



UMI-2325-__	1993-97 LT1 Engine Street Version	599.95 ea.
UMI-2326-__	1993-97 LT1 Engine Road Race Version	799.95 ea.
UMI-2322-__	1993-97 SBC/BBC Engine Street Version	599.95 ea.
UMI-2324-__	1993-97 SBC/BBC Road Race Version	799.95 ea.
UMI-2320-__	1998-02 LS1 Engine Street Version	599.95 ea.
UMI-2321-__	1998-02 LT1 Engine Road Race Version	799.95 ea.
UMI-2318-BARE	1993-02 No Engine Mounts Street Version	549.95 ea.
UMI-2318-__	1993-02 No Engine Mounts Street Version	569.95 ea.
UMI-2319-BARE	1993-02 No Engine Mounts Road Race Version	749.95 ea.
UMI-2319-BLACK	1993-02 No Engine Mounts Road Race Version	769.95 ea.

No Volume Discount. Ships Oversize. Not eligible for free shipping.

UMI LSX Swap Engine Mounts

UMI's LSX adapter plates bolt directly to the frame and allow the installation of any LSX engine. UMI-2406 fits factory LS engine mounts and also works with UMI-2323 solid aluminum motor mounts. UMI's LS mounts place the LS engine in the factory location with the ability to move the engine rear-ward up to 1 in. LS mounts are CNC laser cut from 3/16 in thick steel with MIG welded 1/4 in thick stand offs, high grade mounting hardware included.

UMI-2406-R	1974-92 Red LS Engine Mount	119.95 kit
UMI-2406-B	1974-92 Black LS Engine Mount	119.95 kit
UMI-2323	1998-02 LS Solid Aluminum Engine Mount	159.95 kit
UMI-2328	1998-02 LS Solid Steel Engine Mount	99.95 kit

No Volume Discount.

UMI Solid & HD Motor Mounts

UMI-90058	1974-92 SBC HD Engine Mount On Engine	39.95 pr.
UMI-90051	1974-92 SBC Solid Engine Mount On Frame	79.95 pr.
UMI-90059	1974-92 SBC Solid Engine Mount	109.95 pr.

No Volume Discount.



UMI-2406-R



UMI-90059



UMI-2005-B

UMI Strut Tower Brace

The UMI Performance shock tower brace positively connects the front right and left shock towers together for firm handling and improved steering response. The shock tower brace is constructed of DOM mild steel tubing 1.250 inch OD x 0.095 inch wall using CNC machined 0.250 inch thick mounting plates.

UMI-2005-R	1993-02 Red Mild Steel.....	79.95 ea.
UMI-2005-B	1993-02 Black Mild Steel	79.95 ea.
UMI-2006-R	1993-02 Red Chromoly Steel*.....	149.95 ea.
UMI-2006-B	1993-02 Black Chromoly Steel*.....	149.95 ea.

*Chromoly Steel Tubing shock tower braces are constructed of 1.250 inch x 0.083 inch 4130. No Volume Discount. Ships Oversize. Not eligible for free shipping.



UMI Street Performance Mono-tube Shocks

The UMI Performance monotube rear shock is designed to bridge the gap between basic street shocks and aggressive racing shocks. Medium-firm compression valving provides crisp handling and absorbs bumps while still providing a comfortable ride.

UMI-S120	1970-81 Front Shock Non Adj*	139.99 ea.
UMI-S121	1970-81 Front Shock 20 Step Adj..	239.99 ea.
UMI-S140	1970-81 Rear Shock Non Adj	139.99 ea.
UMI-S42040	1970-81 Front & Rear Kit.....	549.99 kit

*These shocks are designed to work with aftermarket tubular control arms only. No Volume Discount.



UMI-S140

UMI-S121



UMI-8741-1030SPORT



UMI-8250-1005



Koni Shocks & Kits

Koni "Yellow" sport struts and shocks are widely considered to be the best standard mount bolt-on shock for corner carving. This Koni SPORT kit is a direct replacement for the worn factory shocks on your Camaro. Koni Yellows feature excellent handling combined with a sport oriented, corner carver worthy feeling. Yellow shocks and struts are on car adjustable unless otherwise noted.

Koni "Orange" STR-T shocks are considered to be a great choice for handling on a budget mount bolt-on shock for corner carving. This Koni STR-T shock kit is a direct replacement for the worn factory shocks on your Camaro. Koni Orange shocks feature excellent handling combined with a smooth ride on the street. Orange shocks are non-adjustable.

Shocks & Struts Only

UMI-8741-1030SPORT	1982-92 Front Yellow	261.95 ea.
UMI-30-1265SPORT	1982-02 Rear* Yellow	119.95 ea.
UMI-207301	1982-92 Front/Rear Yellow.....	859.99 kit
UMI-207302	1982-92 Front/Rear* Yellow.....	759.95 kit
UMI-207401	1993-02 Front/Rear Yellow.....	957.95 kit
UMI-8241-1139SPORT	1993-02 Front Yellow	309.95 ea.
UMI-8241-1140SPORT	1993-02 Rear Yellow	169.95 ea.
UMI-8250-1005	1993-02 Front Orange	88.95 ea.
UMI-8250-1006	1993-02 Rear Orange	82.95 ea.

Shock Strut & Drop Spring Kits

UMI-207306	1982-92 Front/Rear* Yellow.....	1019.95 kit
UMI-207305	1982-92 Front/Rear Yellow	1089.95 kit
UMI-2061SPORT	1993-02 Front/Rear Yellow.....	1197.99 kit
UMI-2061STRT	1993-02 Front/Rear Orange	579.95 kit

*Rear shock must be removed for adjustment.



UMI-2048-300

UMI Front Coilover Shock Kits

UMI's Camaro front coilover kit permits installation of a true 2-1/2 inch racing coilover spring and shock into your 1993-2002 Camaro. Factory style lower t-bar fits factory GM, UMI and most other brands of lower arms intended for stock t-bar.

UMI-2048-300	1993-02 300 lbs Springs 2X Adj....	749.99 kit
UMI-2048-350	1993-02 350 lbs Springs 2X Adj....	749.99 kit
UMI-2048-450	1993-02 450 lbs Springs 2X Adj....	749.99 kit
UMI-2048-550	1993-02 550 lbs Springs 2X Adj....	749.99 kit
UMI-2053-600T	1993-02 600 lbs Springs 1X Adj..	1039.99 kit

No Volume Discount.



UMI-2046-110

UMI Rear Coilover Shock Kits

UMI's bolt-in rear coilover kit allows full ride height, spring rate and damping adjustability for your 1982-2002 Camaro. The double shear upper mount is a direct bolt-in and holds a true 2-1/2 inch racing coilover. The FEA designed lower bracket bolts in using the standard shock mounting hole as well as an additional reinforcement hole.

UMI-2046-110	1982-02 110 lbs Springs 2X Adj....	729.99 kit
UMI-2046-125	1982-02 125 lbs Springs 2X Adj.....	729.99 kit
UMI-2046-150	1982-02 150 lbs Springs 2X Adj.....	729.99 kit
UMI-2054-200	1982-02 200 lbs Springs 1X Adj...	1039.99 kit

No Volume Discount.



UMI-20-600200T

UMI Competition Coilover Shock Kit Complete

UMI's 4th Gen Camaro competition coilover package is built to perform. Developed in conjunction with Sam Strano (14x national SCCA auto-x champion), the Afco built monotube dampers provide race winning performance in auto-x and road race while still providing an awesome street ride.

UMI-20-600200T	1993-02	2079.99 kit
UMI-2045	1982-02 Rear Hardware*.....	199.99 kit
UMI-2057	1982-02 Spanner Wrench	19.95 ea.

*Mounting Hardware Only

No Volume Discount. Ships Oversize. Not eligible for free shipping.



UMI Rear Control Arms

UMI's heavy duty control arms are direct replacements of the weak, factory stamped rear lower control arms. UMI's control arms are constructed of mild steel tubing with CNC machined ends. These direct bolt-on replacements are designed to minimize wheel hop and improve cornering, while lowering track ETs and helping track consistency. Control arms come complete with bushings, grease fittings when applicable, zinc-plated steel sleeves and finished in a gloss powder coat. Insert color choice in ___ R = Red B = Black

Non-Adjustable Lower

UMI-2015-__	1982-02 Poly Bushings	89.95 pr.
UMI-2033-__	1982-02 Poly Bushing/RotoJoint	219.95 pr.
UMI-2033-__	1982-02 RotoJoint/RotoJoint.....	219.95 pr.

Adjustable Lower One End Only

UMI-2018-__	1982-02 Poly Bushings	219.95 pr.
UMI-2016-__	1982-02 Poly Bushing/Rod End HD Chromoly.....	189.95 pr.
UMI-2013-__	1982-02 Poly Bushing/Rod End Street.....	249.95 pr.
UMI-2039-__	1982-02 Poly Bushing/RotoJoint	269.95 pr.

Adjustable Lower Both Ends

UMI-2017-__	1982-02 Rod End/Rod End	249.95 pr.
UMI-2017CM-__	1982-02 Rod End/Rod End HD Chromoly	289.95 pr.
UMI-2017OF-__	1982-02 Offset Rod End/Rod End.....	249.95 pr.
UMI-2017OFCM-__	1982-02 Offset Rod End/Rod End HD Chromoly	289.95 pr.
UMI-OFFSET	1982-02 Offset Rod End Spacers Only.....	24.95 set
UMI-3007	Angle Finder Tool.....	10.95 ea.

No Volume Discount. Ships Oversize. Not eligible for free shipping.



UMI Rear Toe Rods

The rear toe rods control the camber alignment of the rear end preventing the tire from moving inward or outward during suspension load. The factory toe rods are made from flimsy stamped steel and feature soft rubber bushings causing deflection which leads to erratic handling, poor traction and possible rear tire wear. Replacing the factory arms with heavy duty toe rods makes for a more stable suspension, improved traction and better braking. Insert color choice in ___ R = Red B = Black

Non-Adjustable 2 Piece Kit

UMI-2520-__	2010-14 Poly Bushings Boxed	129.95 pr.
UMI-2521-__	2010-14 RotoJoint Bushings Boxed.....	229.95 pr.

Non-Adjustable With Trailing Arms 4 Piece Kit

UMI-201520-__	2010-14 Poly Bushings Boxed	169.95 kit
---------------	-----------------------------------	------------

Adjustable 2 Piece Kit

UMI-2523-__	2010-14 Poly Bushings Tubular.....	229.95 pr.
UMI-2522-__	2010-14 Rod End Bushings Tubular Cromoly	249.95 pr.
UMI-2524-__	2010-14 RotoJoint Bushings Tubular Cromoly	299.95 pr.
UMI-2518	2010-14 Anti-Eccentric Washers 4pc	12.95 kit

No Volume Discount.



UMI Torque Arms & Kits

Track abuse, street abuse or just flat-out abuse, this torque arm is designed to handle it all! Eliminate unwanted traction problems by adding a UMI Performance tunnel brace mounted torque arm. This aftermarket torque arm replaces the flimsy factory torque arm while adding strength, rigidity and eliminating suspension flex. Insert color choice in ___ R = Red B = Black

Tunnel Brace Mounted Kits

UMI-2202-__	1993-02 w/ Long Tube Headers.....	469.95 kit
UMI-2200-__	1993-02 w/ Factory Manifolds.....	449.99 kit

Tunnel Brace Mounted Kits With Drive Shaft loop

UMI-2203-__	1993-02 w/ Long Tube Headers.....	499.95 kit
UMI-2201-__	1993-02 w/ Factory Manifolds.....	479.99 kit

Weld In Kits With Crossmember

UMI-2235-__	1993-02 w/ Dipped Crossmember.....	479.95 kit
UMI-2236-__	1993-02 w/ Straight Crossmember	479.95 kit

No Volume Discount. Ships Oversize 2. Not eligible for free shipping.



UMI Torque Arm Relocations Kits

Installing a TH350 or TH400 Automatic transmission into your 1993-1997 Camaro just got easier. This crossmember with integrated torque arm mount features the correct provisions for mounting the transmission while still allowing the use of a factory style torque arm. The built in torque arm mount will work with virtually any stock style aftermarket torque arm as well as the factory torque arm and features instant center adjustment by moving the front of the torque arm up or down. Insert color choice in ___ R = Red B = Black

UMI-2226-__	1993-97 w/ TH350	259.95 kit
UMI-2224-__	1993-97 w/ TH400	259.95 kit
UMI-2208-__	1998-02 w/ Factory Auto.....	259.95 kit
UMI-2207-__	1998-02 w/ Factory Manual	259.95 kit
UMI-2212-__	1998-02 w/ TH350.....	259.95 kit
UMI-2213-__	1998-02 w/ TH400.....	259.95 kit

No Volume Discount. Ships Oversize 2. Not eligible for free shipping.



UMI Driveshaft Safety Loop

This NHRA legal driveshaft safety loop is a bolt-in application for the 1993-2002 Camaro. This item bolts to existing floor pan holes to replace of the factory tunnel brace and requires no welding. This is a must for tracks that require a safety loop for cars running faster than 13.99 in the quarter mile. The loop is constructed of 0.250 inch thick mild steel with CNC machined mounting points for a superb fit. Driveshaft safety loop includes new hardware and installs in 30 minutes using basic hand tools. Driveshaft loop will not work with UMI tunnel mounted torque arms or similar tunnel mounted torque arms. It will clear with the stock torque arm, UMI transmission mounted torque arms and most aftermarket torque arms bolting into the factory location. Insert color choice in ___ R = Red B = Black

UMI-2240-__	1993-02 All	119.99 ea.
-------------	-------------------	------------

No Volume Discount.



UMI-2019-R

UMI Rear Panhard Bar

UMI's tubular panhard bar kits are a direct replacement for the flimsy stock stamped panhard bar. They add strength as well as bushing improvement. The panhard bar greatly increases rear stability, controls side movement and body flex; a must when hard driving habits are present.

Insert color choice in ___ R = Red B = Black

Non-Adjustable

UMI-2020-__	1982-02 Poly Bushings	79.95 kit
-------------	-----------------------------	-----------

Adjustable

UMI-2019-__	1982-02 Single Adjustable Poly Bushing/Poly Bushing.....	109.95 kit
UMI-2021-__	1982-02 Single Adjustable Poly Bushing/Rod Ends	109.95 kit
UMI-2036-__	1982-02 Single Adjustable Poly Bushing/RotoJoint Ends	129.95 kit
UMI-2038-__	1982-02 Double Adjustable RotoJoint/RotoJoint Ends	199.95 kit
UMI-2037-__	1982-02 Double Adjustable RotoJoint/RotoJoint Ends.....	169.95 kit

Adjustable On The Car

UMI-2029-__	1982-02 Single Adjustable Poly Bushing/Poly Bushing.....	129.95 kit
UMI-2022-__	1982-02 Double Adjustable Poly Bushing/Rod Ends	149.95 kit
UMI-2023-__	1982-02 Double Adjustable Rod Ends / Rod Ends Ends.....	159.95 kit
UMI-2037-__	1982-02 Double Adjustable RotoJoint/RotoJoint Ends	169.95 kit

Relocation Kit 2 Piece

UMI-2024-__	1982-02	179.95 kit
-------------	---------------	------------

No Volume Discount. Ships Oversize. Not eligible for free shipping.



UMI-2080-275-B



1982-02 Watts Link Kits

The UMI Watts Link is designed as a key component to optimize the 3rd and 4th generation Camaro solid axle rear suspension. The combination of lateral locating ability and roll center height adjustment makes a Watts Link the best choice for axle location in handling cars. Clears up to 5" exhaust.

Kits For Factory Rear Ends

UMI-2080-275-B	1982-02 Black.....	799.95 ea.
UMI-2080-275-R	1982-02 Red.....	799.95 ea.

Kits For Rear Ends With 3" Axle Tubes

UMI-2080-300-B	1982-02 Black.....	799.95 ea.
UMI-2080-300-R	1982-02 Red.....	799.95 ea.

No Volume discount.

STEERING PARTS & ACCESSORIES

NO CORE CHARGE



GBK-1A

Power Steering Gearbox Kits

Now you can add one of these awesome "close ratio" gear boxes to your conversion. These boxes are original re-manufactured GM units and will add the ultimate handling to your ride. Our kit comes with steering box, GM steering coupler (rag joint) and correct attaching bolts. Choose from fast ratio or super fast ratio! No core charge!

1967-69 Camaro

GBK-1F	3 - 3.5 Fast.....	290.49 kit
GBK-1SFF	2.5 Super Fast	316.03 kit

1970-76 Camaro

GBK-1A	3 - 3.5 Fast.....	298.24 kit
GBK-1SFA	2.5 Super Fast	323.78 kit

No volume discount. Ships UPS Oversize.

Steering Coupler Bolt

Correct OEM bolt for coupler.

ATJ-411	1967-76 All	5.99 ea.
---------	-------------------	----------



ATJ-411

BSB-759

Steering Box Bolt

Complete with correct thick washer and bolt.

BSB-757	1967-69 All	3.95 ea.
BSB-759	1970-76 All	6.99 ea.

NO CORE CHARGE

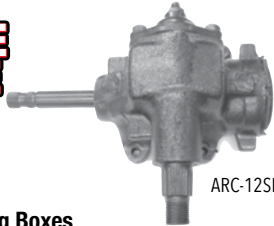

ARC-12SF

Manual Steering Boxes

Complete remanufactured original Saginaw assemblies. Choose from standard or quick ratio. No core charge.

ARC-12A	1967-69 24:1 Std	289.95 ea.
ARC-12B	1970-76 24:1 Std	289.95 ea.
ARC-12SF	1967-76 16:1 Quick	309.95 ea.

Note: Use ATE-8869B coupler with ARC-12SF.

No volume discount. Ships UPS Oversize.

D-1870



Pitman Arm

OEM pitman arm.

Manual Steering

DA-985	1967-69	75.95 ea.
DA-138Z	1967-69 Z/28 Fast Ratio.....	169.95 ea.
DA-811	1970-81	89.95 ea.

Power Steering

D-1870	1967-69	69.95 ea.
DA-711	1970-81	109.99 ea.

Pitman Arm Nut

Correct nut with washer.

BX-64K	1967-81 w/ Power.....	6.95 ea.
--------	-----------------------	----------



BX-64K

ES-48DB

Tie Rod Dust Boots

Correct tie rod end dust boots.

Approx. 1-3/16" on bottom and 1-1/4" on top with a 1/2" hole.

ES-48DB	1967-92 4pc	23.95 kit
---------	-------------------	-----------



IIS-70F

IIS-78

IIS-78S

Intermediate Steering Shaft

Restore proper steering stability and safety with this newly remanufactured intermediate steering shaft. This shaft goes from the steering column down to the steering box and wears out over time, causing sloppy steering feel.

IIS-70F	1970-76 All	205.95 ea.
IIS-78	1978-92 All w/o Shroud.....	119.95 ea.
IIS-78S	1978-92 All w/ Shroud.....	139.95 ea.



ATE-8869B

ATE-8871

ATE-8869A

Steering Coupler

Complete joint for connecting column to box. 1967-69 with manual steering features fine spline and 1970-76 with manual steering features coarse spline.

ATE-8869A	1967-69 Manual.....	49.95 ea.
ATE-8869B	1970-76 Manual.....	49.95 ea.
ATE-8871	1967-76 Power	49.95 ea.

STEERING *continued*



SALE

**Concourse Series
"Banjo" Style Power
Steering Pumps**

These are brand new banjo style power steering pumps with correct reservoir and inlet and outlet fittings. No Core Charge.

APS-6086	1967-68 All V8	175.95 ea.
APS-6153	1969 SB	179.95 ea.
APS-6151	1969 BB	179.95 ea.
APS-6165	1970-72 All V8*	179.95 ea.

*Use with 1970 hose & brackets. No Volume Discounts.

NO CORE CHARGE

**Power Steering Pumps -
Replacement**

Completely rebuilt second design power steering pumps. These pumps will differ in appearance from our originals, but will fit and function the same.

No core charge!

APS-6000R	1969-72 All	99.95 ea.
-----------	-------------------	-----------

No volume discount



TUF-6183B



TUF-6195A

Tuff Stuff Power Steering Pumps

GM Saginaw style pumps feature all new components reservoir, pump assembly, cap & dipstick and hardware when it applies. Rated at 1200 psi, rated to work with most gearbox systems.

TUF-6197A	1967-68 SB Chrome Banjo Style	235.99 ea.
TUF-6197B	1967-68 SB Black Banjo Style	186.99 ea.
TUF-6195A	1969 BB Chrome Banjo Style	235.99 ea.
TUF-6195B	1969 BB Black Banjo Style	186.99 ea.
TUF-6193A	1970 All Chrome Banjo Style	235.99 ea.
TUF-6193B	1970 All Black Banjo Style	186.99 ea.
TUF-6182A	1970-74 All Chrome	221.99 ea.
TUF-6182B	1970-74 All Black	174.99 ea.
TUF-6183B	1970-74 All Black	174.99 ea.
TUF-6182A	1975-78 All Chrome	221.99 ea.
TUF-6182B	1975-78 All Black	174.99 ea.
TUF-6181A	1979 All Chrome	221.99 ea.
TUF-6181B	1979 All Black	174.99 ea.
TUF-6180A	1980-81 All Chrome	221.99 ea.
TUF-6180B	1980-81 All Black	174.99 ea.
TUF-6179A	1982-87 All Chrome	221.99 ea.
TUF-6179B	1982-87 All Black	174.99 ea.
TUF-6184A	1988-92 All Chrome	221.99 ea.
TUF-6184B	1988-92 All Black	174.99 ea.
TUF-5559	All Inline Filter	32.99 ea.

No volume discount.



Power Steering Pump Cap

Quality replacement power steering pump cap.

ADR-077	1967-81 All	8.95 ea.
---------	-------------------	----------

OE Power Steering Pump Cap

OE style reproduction metal cap.

APC-42	Metal Cap	19.95 ea.
--------	-----------------	-----------

Power Steering OEM High Pressure Hose

New correctly bent OEM high pressure hoses with correct fittings.

OEM



CPX-6616	1967-68 All V8	26.95 ea.
----------	----------------------	-----------



CPX-6602	1969 All V8	26.95 ea.
----------	-------------------	-----------



CPX-6618	1970-72 Big Block	26.95 ea.
----------	-------------------------	-----------



CPX-263	1970-72 SB (All V8 73-76)	26.95 ea.
CPX-277	1977-79 All V8	26.95 ea.



CPX-634	1980-81 All V8	26.95 ea.
---------	----------------------	-----------

BUY'N SAVE WITH KITS



ARK-678F



Power Steering Hose Kits

This kit comes with OEM high pressure hose, low pressure return tube, hose and correct clamps

ARK-678F	1967-68 All V8	38.17 kit
ARK-69F	1969 All V8	39.96 kit
ARK-70F	1970-72 V8	39.96 kit

No Volume Discount



NPX-16

Power Steering Return Hose

Complete with correct pre bent flared tube, OEM hose and correct clamps.

NPX-16	1967-76 All V8	17.95 kit
CPS-038	OEM Return Hose	2.95 per ft
CPN-512	OEM Clamps Screw Type	1.95 ea.



AFP-513

Power Steering Pump Fitting

OE style reproduction of the very difficult to find power steering pump fitting which is usually missing on remanufactured pumps.

AFP-513	1969 All	34.95 ea.
---------	----------------	-----------



ASC-128

Power Steering Hose Retaining Clip

Correct clip for retaining hose to steering box.

ASC-128	All V8	12.95 ea.
---------	--------------	-----------



AB-31F

Power Steering Hose Retainer

This often missing retainer secures the two steering hoses to the frame.

AB-31F	1967-69 All V8	20.95 ea.
--------	----------------------	-----------



ADP-61

1967-68 396 Driver Pulley

OE style reproduction of the 1967-68 SS396 only power steering driver pulley.

ADP-61 1967-68 BB Driver44.95 ea.



ASP-509



23-28

Power Steering Pump Pulleys

OE style reproduction power steering pulleys.

ASP-3847 1967-69 1 Groove Deep Cast 302, 396/375, 427155.95 ea.
 ASP-509 1967-81 1 Groove36.95 ea.
 ASP-107 1969-81 2 Groove w/ AC44.99 ea.
 ASP-1395 1969-81 1 Groove SHP49.99 ea.
 23-28 Pulley Nut3.95 ea.

Power Steering Brackets

Original style reproduction and original GM brackets



ASB-366

ASB-366 1967-68 SB Cradle49.95 ea.
 For use with short water pump.



ASB-383

ASB-383 1967-68 Z/28 / SS35039.95 kit
 For use with short water pump.



ASB-184

ASB-184 1967-68 SS396 Cradle64.99 ea.
 For use with short water pump.



ASB-186

ASB-186 1967-68 396 Adjuster39.99 ea.
 For use with short water pump.



AQW-1418

AQW-1418 1969 All BB (3 piece)64.99 kit
 Works with original long water pump & P/S pump.



ASB-3941

ASB-3941 1969-76 All SB Cradle25.95 ea.
 For use with long water pump.



ASB-874

ASB-874 1969-72 SB Rear Support35.95 ea.
 For use with long water pump.



AAB-2610

AAB-2610 1969-76 SB Adjuster35.95 ea.
 For use with long water pump.



ASB-422

ASB-422 1970-72 All BB Cradle32.95 ea.
 For use with long water pump.



ASB-931

ASB-931 1970-81 All BB (adjuster)24.95 ea.
 For use with long water pump.



BSB-671

Power Steering Hardware Kits

Our kits feature all correct hardware to attach power steering brackets to engine. A MUST!

G-4804 1967 SB 302,35015.99 kit
 G-4805 1967 BB 39615.99 kit
 G-4917 1968 SB 302,35015.99 kit
 G-4918 1968 BB 39615.99 kit
 G-4805 1967 BB 39615.99 kit
 BSB-69SB 1969-74 SB All11.99 kit
 BSB-1969 1969 All BB17.99 kit
 BSB-1970 1970+ All BB12.95 kit



ASB-7KIT

1969-81 Big Block Power Steering Bracket Kit

Complete kit with cradle, adjustment brackets and hardware.

ASB-7KIT 1969-81 All BB63.77 kit
 Will work on most BB engines with 1969 and up style long pump. May need some modification.



ASB-9KIT

1969-72 Small Block Power Steering Bracket Kit

Complete kit with all three brackets.

ASB-9KIT 1969-72 SB88.07 kit
 Will work on most SB engines with 1969 and up style long pump. May need some modification.

BUY 'N SAVE WITH KITS

BUY'N SAVE
WITH KITS



SHIFTKIT-F63

Console Shifter Kit

Complete kit to convert to an automatic console shifter. Kit includes factory style staple shifter, cable, brackets & all correct hardware.

SHIFTKIT-F63	1968-69 TH350.....	202.16 kit
SHIFTKIT-F64	1968-69 TH400.....	202.16 kit
SHIFTKIT-F73	1970-72 TH350.....	221.71 kit
SHIFTKIT-F74	1970-72 TH400.....	221.71 kit

No Volume Discount



ISS-6F

1968-69 Staple Shifter

OE style reproduction complete automatic staple shifter assembly for your 1968-69 Camaro.

ISS-6F	1968-69	139.99 ea.
--------	---------------	------------

No Volume Discount



ISH-640

1970-72 Staple Shifter

OE style reproduction complete automatic staple shifter assembly for your 1970-72 Camaro.

ISH-640	1970-72	162.99 ea.
---------	---------------	------------

No Volume Discount



ISH-3X

Staple Shifter Handle

OE style reproduction staple shifter handle complete with spring loaded lock out trigger.

ISH-3X	1968-72	79.99 ea.
--------	---------------	-----------



Staple Shifter Repair Kit

ISSFT-HRDW

All the hardware needed to bring a worn out staple shifter back to life.

ISSFT-HRDW	1968-72 ALL	32.99 kit
------------	-------------------	-----------

No volume discount.



SW-DT3

Ratchet Shifter Detent

Converts your factory shifter to a ratchet type shifter. Simple installation.

SW-DT3	1968-69 Powerglide, TH350, TH400	95.95 ea.
SW-DT4	1968-69 700-R4, 200-4R, 4L60, 4L65, 4L80	95.95 ea.



SC2244

4 Speed Overdrive Kits

This kit makes it easy to install a modern overdrive automatic in place of your old Powerglide, TH350 or TH400 for improved performance and gas mileage. Each kit includes a new laser cut and hardened detent, indicator plate, hardware and brackets to allow the use of your factory shifter. This kit works with a TH700, TH200 or 4L60 transmission.

S105-DB	1967	174.95 kit
SC2244	1968-69	99.95 kit
SC2614	1968-69 4L60	99.95 kit
SC2245	1970-72	99.95 kit
SC2615	1970-72 4L60	99.95 kit
SC2261	1973-78	99.95 kit
SC2262	1979-81	99.95 kit



SW280-RCT

1967 Universal Shifter Kit

Universal Camaro shifter that has the look of the factory shifter setup for both the 3 speed TH350/TH400 overdrive 700-R4, 200-4R, 4L60, 4L65 and the 4L80. Complete with neutral safety/back up switch, all rod linkage components and factory-like reverse lock out and detents for each gear. Also includes a universal floor mounting bracket kit.

SW280-RCT	1967 All	349.95 kit
-----------	----------------	------------



1967 Shifter Conversion Kit

S105-DA

Convert your factory 2 speed PowerGlide console shifter to a 3 or 4 speed shifter.

S105-DA	1967 All w/ TH350/400.....	174.95 kit
S105-DB	1967 All w/ TH200R4/700R4 4L60E.....	174.95 kit

This kit uses rod linkage, not a cable.



ISH-724

1967 Auto Shifter Button

This will replace your worn or lost shift handle button perfectly.

ISH-724	Button	14.95 ea.
ISH-724-SPRING	Spring	6.95 ea.

IQ-110P



IQ-110T



Shift Indicator Lenses

Injection molded clear shift indicator lenses.

IQ-109	1967 Powerglide	9.99 ea.
IQ-127	1967 TH350/TH400	6.99 ea.
S121	1967 700-R4/200-4R	18.95 ea.
IQ-110P	1968-69 Powerglide	7.99 ea.
IQ-110T	1968-69 TH350/TH400.....	8.99 ea.
S150	1968-69 Reverse Pattern	24.95 ea.
S120	1968-69 700-R4/200-4R	19.95 ea.



IC-123



IC-45



IC-124

Shifter Sliders

Correct die stamped plastic shifter sliders.

IC-123	1967 Manual	7.99 ea.
IC-45	1967 Automatic	7.99 ea.
IW-340	1967 Slider Retainer.....	6.99 ea.
IC-124	1968 Manual	7.99 ea.
IC-158	1968 Slider Retainer.....	12.99 ea.



3917438



Hurst Shifter

New Hurst Competition Plus shifter complete with Hurst handle and shifter ball.

3914339	1967-68 Muncie.....	411.99 ea.
3917438	1969 Muncie.....	413.99 ea.
3916848	1970-72 Muncie.....	405.99 ea.
3917438	1973-77 Muncie.....	413.99 ea.
HURST-3917960	1982 Console/Borg Warner.....	405.99 ea.

No Volume Discount



3734529

Hurst Installation Kits

Complete kit with rods, levers, swivels and hardware.

3734529	1967-68 Muncie.....	218.99 kit
3737437	1969 Muncie.....	231.99 kit
3737897	1970-72 Muncie.....	243.99 kit
3738605	1973-74 Muncie.....	243.99 kit
3738609	1974-81 BWT10.....	236.99 kit

No Volume Discount



HURST-69

FACTORY STYLE

1969 OE Hurst Shifter

OE style reproduction of the highly sought after shifter used on all 1969 Camaro 4 speeds. Features correct style handle exclusive to 1969 Camaros.

HURST-69	1969 All.....	399.95 ea.
----------	---------------	------------



HURST-69BB

1969 OE Hurst Shifter Installation Kits

Correct installation hardware kits for your 1969 Hurst Shifter.

HURST-69SB	1969 SB.....	136.95 ea.
HURST-69BB	1969 BB.....	249.95 ea.

Use with Hurst-69



Billet Shifter Handles

These billet aluminum shifter handles from Clayton Machine work with any Hurst or Tremec, TKO500, TKO600 2 bolt shifter mount and are a great finishing touch for your custom ride! Available in three styles. Basic black anodized, truss style with grey powder coat, truss style adjustable grey powder coat. Shift knob not included. Requires knob with 3/8-16" thread. Same as most Hurst knobs.

SH-203-8	8" Black Anno 30° Kick Back.....	169.99 ea.
SH-203-10	10" Black Anno 30° Kick Back.....	175.99 ea.
SH-202-8	8" Grey PC Truss Style 30° Kick Back.....	132.99 ea.
SH-202-10	10" Grey PC Truss Style 30° Kick Back.....	137.99 ea.
SH-204-10	10" Grey PC Truss Style Adj Kick Back.....	228.99 ea.

No volume discount.



FW-115

FZ-1420

FW-157

Shifter Balls

OE style reproduction shifter balls.

FZ-1420	Muncie White 5/16".....	21.99 ea.
FZ-1424	Hurst White 3/8".....	24.99 ea.
FW-115	Chrome 5/16".....	24.99 ea.
FW-117	Chrome 3/8".....	23.99 ea.
FW-157	Black/Chrome 5/16".....	21.99 ea.
FW-159	Black/Chrome 3/8".....	21.99 ea.
FW-38HURST	Hurst White 3/8" 4 Speed.....	38.99 ea.



FZ-8289A

FZ-8289M

1982-89 Z/28 Leather Wrapped Shift Knob

Reproduction of the factory original leather-wrapped shift knob.

FZ-8289A	1982-89 Auto.....	79.99 ea.
FZ-8289M	1982-89 Manual.....	79.99 ea.

No volume discount.



FW-HURST

Hurst T Handle Shifter Knob

This brushed aluminum T-handle provides a positive feel for accurate gear selection. A favorite in the performance world for years! Includes adapters for most popular shift handles.

FW-HURST	T-Handle.....	36.99 ea.
HURST-1530010	T-handle Bushed Alum w/ Button.....	72.99 ea.
HURST-1530011	T-handle Polished Alum w/ Button.....	72.99 ea.



IQ-341

Shifter Tunnel

Correct molded plastic which installs on inside of console.

IQ-341	1969 4 Speed.....	24.99 ea.
IQ-964	1970-72 4 Speed.....	29.99 ea.
IQ-571	1973-81 4 Speed.....	44.99 ea.

NA-578



Reverse Lockout Kit

Complete with 2 rods and swivel mechanism.

NA-578	1969 All.....	84.95 kit
NA-704	1970-74.....	134.95 kit

REVSKIT-UNI



Universal Reverse Lamp Switch Manual

This kit allows you to add a reverse light switch to non-stock applications. If you have a Hurst shifter this kit is a must.

REVSKIT-UNI	All.....	38.99 ea.
-------------	----------	-----------



ICE-09

ICE-4526

IK-407

ICE-3966

ICE-78UP

ICE-HURST

Shifter Boots

Brand new injection molded boots.

ICE-09	1967-68 w/o Console.....	26.99 ea.
ICE-4526	1967-68 w/ Console.....	22.95 ea.
IK-8UP	1968 Upper w/ Console.....	8.99 ea.
IK-407	1969 All.....	22.95 ea.
ICE-3966	1970-81 Lower.....	23.99 ea.
ICE-78UP	1970-81 Upper.....	22.95 ea.
ICE-HURST	Universal.....	59.99 ea.



IQ-635

IK-476

ICE-1516

IW-764

Shift Boot Retainers

Correct die stamped steel boot retainers.

IQ-635	1967-68 w/o Console 2pc.....	43.99 ea.
IK-476	1967-68 w/ Console.....	17.99 ea.
ICE-1516	1969 w/o Console Black.....	12.99 ea.
ICE-1562	1969 w/ Console Chrome.....	16.99 ea.
IW-764	1970-81 All.....	21.99 ea.

IQ-65



4 Speed Emblem

Correct 4 speed console emblems.

IQ-65	1968-69.....	15.99 ea.
-------	--------------	-----------

ISP-F685R



5 & 6 Speed Emblem

5 or 6 speed emblems that look stock!

ISP-F685T	68-69 Tremec 5 Speed.....	51.99 ea.
ISP-F685R	68-69 Richmond 5 Speed.....	51.99 ea.
ISP-F686T	68-69 Tremec 6 Speed.....	51.99 ea.
ISP-F686R	68-69 Richmond 6 Speed.....	51.99 ea.



HURST-3160001

HURST-3838530



Hurst Automatic Shifters

From the originator of high performance manual shifters, is our line of performance street and racing shifters for automatic transmissions that won't let you down.

Pro-Matic 2

Ratchet-action shifter with its chrome-plated stick and black knob is quality engineered for years of precise, trouble-free operation.

HURST-3838500 All 3 Speed.....310.99 ea.

V-Matic 3 Shifter

Designed with a park and reverse lock trigger actuating system that allows smooth and flawless ratcheting through the forward gears.

HURST-3838530 All 3 & 4 Speed.....361.99 ea.

Quarter Stick

The Quarter Stick shifter provides positive gear change control for both street and race applications. Its compact size fits easily in racecars with limited space and is very lightweight at only 2.5 pounds. Features include black oxide coated steel construction, 1018 hardened steel gate plate, forged aluminum shift stick with 7/16-20 tpi and a classic white Hurst shift knob.

HURST-3160001 All 2 Speed*.....312.99 ea.

HURST-3160006 All 3 Speed**.....312.99 ea.

HURST-3160020 All 3 Speed*.....315.99 ea.

*Reverse valve body. **Forward valve body.



HURST-3916029

HURST-3916030

HURST-3916131

1982-19 Hurst Manual Shifters

Hurst Billet/Plus Shifters incorporate a high ratio pivot mechanism for reduced shifter throw and are sturdily constructed for a more positive precise feel when shifting. Self centering alignment improves 2nd to 3rd up-shift gear changes to reduce the chance of "missed shifts".

- HURST-3917960 1982 w/ 4 Speed405.99 ea.
- HURST-3915061 1993-02 w/ T56 Trans328.99 ea.
- HURST-3916029 2010-15 w/ V6248.99 ea.
- HURST-3916030 2010-15 SS268.99 ea.
- HURST-3916030 2012-15 ZL1268.99 ea.
- HURST-3916030 2014-15 Z/28268.99 ea.
- HURST-3916031 2016-19 SS373.99 ea.
- HURST-3916031 2017-19 ZL1373.99 ea.
- HURST-3916034 2016-17 LT260.99 ea.
- HURST-3916047 2016-17 SS ZL1311.99 ea.
- HURST-3916131 2016-19 SS384.99 ea.

*Without shift knob. No volume discount.

B&M Automatic Floor Shifters

From the originator of high performance manual shifters our line of performance, street and racing shifters for automatic transmissions won't let you down. With classic good looks and proven mechanical designs giving choices of either positive ratcheting actions or gated racing shifters, provide positive shifts guaranteeing you won't miss a shift when it counts.



BM-80885

BM-80675



Starshifter

Features include NHRA/ IHRA reverse lockout, backup light switch, neutral safety switch, polished T-handle. Cable operated for quick installation and accurate shifting.

BM-80675 All 2&3 Speed226.99 ea.

BM-80690



Megashifter

The B&M Megashifter has it all, form, function and classic style. This all adds up to bring you a quality shifter that's been one of the most popular automatic shifters of all time. First off let's talk function. The Megashifter's positive ratcheting function won't allow you to over shift and miss a gear at that critical moment, along with the reverse lockout feature meets NHRA/IHRA safety rules for those weekend grudge races at the track. The look and feel of the T-handle and accordion style shift boot really shows off the racing heritage of the Megashifter.

BM-80690 All 2,3,4 Speed.....364.99 ea.

BM-80694 1973-81 2,3,4 Speed.....369.99 ea.

BM-80683



Quicksilver

The B&M Quicksilver features a ratcheting action for positive shifts, Chrome Knob, neutral safety switch, NHRA/IHRA approved Reverse Lockout.

BM-80683 All 2,3,4 Speed330.99 ea.

BM-80688 1973-81 2,3,4 Speed.....322.99 ea.

Hammer

The Hammer shifter may just be the most comfortable and versatile shifter available. The unique design of the shift handle easily fits all sizes of hands providing the best wrist angle and feel when shifting.

BM-80885 All 2,3,4 Speed.....250.99 ea.

BM-80706



Pro Stick

The Original Pro Stick shifter delivers rock-solid performance, mixed with clean design cues and compact size. This is why you see so many Pro Stick shifters at the race track.

BM-80706 All 2,3,4 Speed321.99 ea.

BM-81052



Stealth Magnum Pro Stick

The Stealth Magnum Grip Pro Stick shifter delivers rock-solid performance, mixed with clean design cues and compact size.

BM-81052 All 2,3,4 Speed305.99 ea.

BM-80840



Pro Ratchet

The Pro Ratchet shifter is one of our most popular and easiest to operate race shifters. Features include a positive ratcheting design that self-centers the handle after each shift giving you maximum clearance behind the shifter and won't allow you to miss a shift by over-shifting a gear. This versatile shifter will operate both forward and reverse shift patterns.

BM-80840 All Silver 2 Speed Powerglide.....324.99 ea.

BM-80842 All Silver 3,4 Speed*324.99 ea.

BM-80843 All Carbon 3,4 Speed*327.99 ea.

BM-81120 All Stealth 3,4 Speed*405.99 ea.

*May require PRNDL switch for some applications. No volume discount.



HURST-5389020 HURST-5389023

Hurst Billet Shifter Handles

This is a great way to add a contemporary performance look to your muscle car. Billet Aluminum construction is precision CNC machined for a modern look and feel. Fits classic Hurst shifters with a 2 bolt pattern.

HURST-5389020	6" Straight	81.99 ea.
HURST-5389021	8" Straight	92.99 ea.
HURST-5389022	10" Straight	102.99 ea.
HURST-5389023	6" Lay Back	92.99 ea.
HURST-5389024	8" Lay Back	102.99 ea.
HURST-5389025	10" Lay Back	125.99 ea.

No volume discount.



HURST-5010002

Hurst Indy Manual Shifters

For the past 60 years Hurst has been the most recognized name in performance shifters.

HURST-5010002	Indy 3 Speed	279.99 ea.
HURST-5030030	Indy 4 Speed	410.99 ea.



HURST-3162001 HURST-3162023

Pistol Grip Quarter Stick

The Pistol-grip Quarter Stick shifter provides positive gear change control for both street and race applications. Its compact size fits easily in racecars with limited space and is very lightweight at only 2.5 pounds. Features include black oxide coated steel construction, 1018 hardened steel gate plate, ergonomic billet aluminum pistol-grip shift handle that incorporates a momentary switch which can be used to activate a Hurst Roll control, a trans-brake or a nitrous system.

HURST-3162001	All Silver Handle 2 Speed*	410.99 ea.
HURST-3162002	All Black Handle 2 Speed*	410.99 ea.
HURST-3162006	All Silver Handle 3 Speed**	410.99 ea.
HURST-3162007	All Black Handle 3 Speed**	410.99 ea.
HURST-3162023	All Black Handle 4 Speed**	412.99 ea.

*Reverse valve body. **Forward valve body. No volume discount.

HURST-5008555



HURST-5000029

Hurst Shifter Cables

These premium quality cables feature a solid 303 stainless steel inner wire core encased within a nylon liner wrapped with helical lay wires and swaged ends for superior strength. The core is lubricated with Teflon prior to assembly and then sealed in a heavy plastic outer casing for a lifetime of durability and smooth operation.

Single eyelet on one end and threaded on the other end.

HURST-5000023	3 Feet	71.99 ea.
HURST-5000025	5 Feet	67.99 ea.
HURST-5000028	8 Feet	86.99 ea.

Single eyelet on one end and threaded on the other end. For Pro-Matic & V-Matic shifters

HURST-5008555	5 Feet	64.99 ea.
---------------	--------------	-----------

Eyelets on both ends for quarter stick.

HURST-5000029	5 Feet	75.99 ea.
---------------	--------------	-----------

No volume discount.



B&M Governor Recalibration Kit

This kit allows you to adjust the shift points of your transmission after it is installed in your vehicle. The Governor Recalibration Kit is very useful if you have a vehicle that is very light; has a low rear-end gear ratio.

BM-20248	55-85 TH350, TH400, TH700R4	81.99 kit
----------	-----------------------------------	-----------

No volume discount.



BM-30228



BM-30229



BM-21042

B&M Transpak, Transkit & Master Overhaul Kits

The B&M Transpak has all the features in the Shift Improver Kit, plus it provides additional driver manual control. Retain full automatic features and standard shift points with selector in drive.

BM-30228	1968-81 TH350	95.99 ea.
----------	---------------------	-----------

B&M Transkits give you the same high-quality components that are used in all B&M Street and Strip transmissions. They also include special directions on how to modify your case, pump and components.

BM-30229	1968-81 TH350	279.99 ea.
----------	---------------------	------------

B&M Master Racing overhaul kits are supplied with all of the gaskets, seals, bushings and friction material required for a complete high performance or racing trans overhaul.

BM-21042	1968-81 TH350	236.99 kit
BM-21041	1968-81 TH400	256.99 kit

No volume discount



FMCK-67S
THIS IS AN EXCLUSIVE GROUND UP PRODUCT

BUY'N SAVE WITH KITS

Manual Transmission Conversion Kit

Planning on swapping from automatic to a 4 speed manual? This kit will take the headache out of the switch by providing you with all of the parts needed to make your conversion simple! This complete kit includes the brake/clutch pedals, Z bar, rods, boots, cross shaft kit, springs, bracket and all hardware!

FMCK-67S	1967-68 SB.....	174.94 kit
FMCK-67B	1967-68 BB.....	185.14 kit
FMCK-69S	1969 SB.....	191.85 kit
FMCK-69B	1969 BB.....	201.45 kit
FMCK-70S	1970-71 V8.....	215.02 kit
FMCK-70B	1972-81 V8.....	215.02 kit

With Headers*

FMCK-67S-HD	1967-68 SB.....	169.81 kit
FMCK-67B-HD	1967-68 BB.....	173.26 kit
FMCK-69S-HD	1969 SB.....	187.02 kit
FMCK-69B-HD	1969 BB.....	195.82 kit

No Volume Discount

*Includes everything that comes in regular kits except for the small spring and extension rod which can't be used for headers.

BUY'N SAVE WITH KITS



FCA-5051

Clutch Linkage Kit

If you're looking to freshen up your original linkage but don't need the pedals, this is perfect!

FCA-5051	1967-69 SB.....	119.05 kit
FCA-5053	1967-69 BB.....	128.65 kit
FCA-5050	1970-81 V8.....	163.81 kit

With Headers

FCA-5051-HD	1967-69 SB*.....	114.22 kit
FCA-5053-HD	1967-69 BB*.....	123.02 kit

*Includes everything that comes in regular kits except for the small spring and extension rod which can't be used with headers.



FCI-1860

Clutch & Brake Pedal Assemblies

Complete reproduction brake/clutch pedals.

FCI-1860	1967-68.....	65.99 ea.
FCI-1869	1969.....	99.99 ea.
FCI-1870	1970-71.....	89.99 ea.
FCI-1872	1972-81.....	89.99 ea.



FCI-1006PA

Clutch & Brake Pedal Complete Assembly

Do you want to convert your Camaro to a 4 speed but are missing the pedals and hanger? This complete 4 speed pedal assembly includes the brake pedal, clutch pedal, pads, rod and hanger which mounts under the dash.

FCI-1006PA	1967-68 4-Speed.....	299.95 ea.
FCI-1006PB	1967-68 Automatic.....	249.95 ea.

BUY'N SAVE WITH KITS



FBH-621SUPERKIT

621 Bellhousing Kit

Complete kit with reproduction "621" bellhousing, clutch fork, fork boot, throw-out bearing, bolts and inspection cover. Fits cars with 11" clutch.

FBH-621SUPERKIT	Complete Kit.....	261.31 kit
FBH-621K	Bellhousing and Cover.....	174.93 kit
FBH-621	Bellhousing Only.....	169.95 ea.



FCK-258

Heavy Duty Clutch Kits

Heavy Duty clutch kits include clutch disc, pressure plate, throw out bearing, pilot bushing, alignment tool and grease pack.

FCK-258	11" 10 Spline BB.....	210.95 kit
FCK-260	11" 26 Spline BB.....	219.95 kit
FCK-105	10.5" 10 Spline SB.....	199.95 kit
FCK-108	10.5" 26 Spline SB.....	199.95 kit
BPP-8386	Flywheel to Pressure Plate Bolts.....	9.99 kit

No Volume Discount



BPB-9021

Bellhousing Hardware

BPB-9021	Bellhousing to Block (6pc).....	8.95 kit
BTE-307	Bellhousing to Trans 4 Speed 4pc.....	8.95 kit



FFW-11

Flywheels

FFW-105	10.5" w/o 454 GM.....	279.99 ea.
HAYS-10-130	11" 396/402.....	331.99 ea.
HAYS-10-010	168t 57-85 SBC 65-70 BBC*.....	95.99 ea.
HAYS-10-020	168t SBC 70-90 BBC**.....	89.99 ea.
BPB-5116	Flywheel to Crank Bolts 4 Spd 12pc....	14.99 kit
BPB-5118	Flex Plate to Crank Bolts Auto 12pc ...	16.99 kit

*Internally balanced. **Externally balanced.

No Volume Discount



FTE-3943

Flywheel Inspection Covers

OE style reproduction flywheel covers.

FTE-3943	1967-69 Manual 11".....	24.95 ea.
NK-4497	1967-69 Manual 10.5".....	23.99 ea.
NJ-088	All Powerglide.....	32.95 ea.
NE-810	All TH350.....	34.95 ea.
NJ-089	All TH400.....	93.99 ea.
BFW-506K	Attaching Bolts 4pc.....	1.95 kit



FEH-397

Clutch Fork

New GM clutch fork.

FEH-397	1967-81 All.....	52.99 ea.
FEH-397-GM	1967-81 All Original "GM".....	105.99 ea.



FKW-4999

Clutch Fork Boot

Original clutch fork dust boot.

FKW-4999	1967-81 All.....	8.95 ea.
FKW-11LW	For Lakewood Scatter Shield Bell Housing.....	30.99 ea.



FPB-66



FPB-667

Pilot Bushing

Correct GM bearings for input shaft.

FPB-ROLLER	All Roller.....	21.99 ea.
FPB-667	All Brass.....	13.95 ea.



FTO-641

Throw Out Bearing

Original OEM throw out bearing.

FTO-641	All.....	44.95 ea.
---------	----------	-----------



FTE-9000

Clutch Fork Ball

Clutch fork mounting ball for inside of bellhousing.

FTE-9000	All.....	13.95 ea.
FTE-9000-ADJ	Adjustable.....	29.95 ea.



FPX-828

Clutch Cross Shaft Kit

Original GM stud balls, nylon seats, protective felts, retaining clips, nuts and washers.

FPX-828	Complete All V8	29.95 kit
FPX-6568	Block Ball Only	13.95 ea.
FPX-5289	Frame Ball Only.....	13.99 ea.
FPX-3349	Plastic Seat Only.....	2.95 ea.
FPX-3360	Ball Felt	8.99 ea.
FPX-0696	Retaining Clip	1.99 ea.
FPX-33K	Cross Shaft Seal and Kit.....	23.06 kit



FK-130

Clutch Frame Brackets

Correct bracket for mounting Z bar to frame.

FK-130	1967-69	12.99 ea.
FEH-086	1970-81	13.99 ea.
BFB-605	Attaching Bolt.....	0.75 ea.

FCI-501

FCI-108

FTE-3082

Clutch Z Bar
OE style reproduction "zerk" bar.

FCI-501	1967-69 SB.....	38.99 ea.
FCI-108	1967-69 BB.....	49.99 ea.
FTE-3082	1970-81 V8.....	69.99 ea.



FKW-95



FRC-100

Clutch Firewall Rods

FKW-95	1967-69 All V8	19.99 ea.
FKW-276	1970-71 All V8	19.99 ea.
FKW-277	1972-81 All V8	19.99 ea.
FRC-100	Attaching Clip.....	1.99 ea.



FKW-209



FCE-0681

Clutch Adjustment Rod Kits

FKW-209	Most SB.....	19.99 kit
FCE-0681	Most BB.....	19.99 kit
FRC-100	Attaching Clip.....	1.99 ea.



FKW-1461

Clutch Return Springs

Original return springs for clutch fork, etc.

FKW-1461	1967-69 SB.....	5.99 ea.
FPC-520	1967-69 BB.....	6.99 ea.
FCE-3920	1970-81 Most.....	6.95 ea.



FKW-1460

Clutch Spring Extension Rod

Correct clutch spring extension rod for small blocks.

FKW-1460	1967-69 SB.....	6.99 ea.
----------	-----------------	----------



FXB-533

Clutch Spring Extension

Correct clutch spring extension which mounts to the exhaust manifold on big blocks.

FXB-533	1967-69 BB.....	6.99 ea.
---------	-----------------	----------



FRB-172

Clutch Pedal Push Rod Bushing

OE style reproduction clutch pedal push rod bushing for various GM models. This injection molded plastic bushing installs on the clutch pedal and retains the clutch push rod. This small bushing is essential for keeping the clutch push rod in the proper location.

FRB-172	1972-83	1.99 ea.
---------	---------------	----------



FPB-97



FPB-103

Clutch Pedal Bushing & Bumper

Correct nylon bushing used for ease of pedal.

FPB-97	All Bushing.....	1.99 ea.
FPB-103	All Bumper	3.95 ea.



Transmission Crossmember

OE style reproduction crossmembers for mounting your transmission.

FCM-85	1967-69 TH400.....	59.95 ea.
FCM-85M	1967-69 TH350 or 4 Speed.....	79.95 ea.
FCM-85B4	1967-69 BB 4 Speed.....	139.95 ea.
FCM-75	1970-81 TH400.....	79.95 ea.
BPC-7000	1967-81 Mountina Bolts 16oc.....	6.95 kit



Hooker Blackheart LS Swap Transmission Crossmembers

- Designed using CAD modeling/FEA analysis for optimal fitment, strength, weight, safety and appearance
- High-strength low-alloy steel construction
- Engineered 3 to 3.5 degree engine/transmission inclination
- Designed in conjunction with Hooker LS engine swap brackets
- Will install with either a stock rubber or Energy 3-1108 poly mount
- Provides the highest clearance available for up to 3" exhaust system routing

HKR-12625HKR	67-69 4160E* 4L65/70/75.....	255.99 ea.
HKR-12626HKR	67-69 T56, T56 Magnum.....	255.99 ea.
HKR-12616HKR	70-81 4160E* 4L65/70/75.....	250.99 ea.
HKR-12614HKR	70-81 T56, T56 Magnum.....	260.99 ea.

*2 piece case only. No volume discount.



GForce Transmission Crossmembers

When you need extra exhaust clearance or just want to make your car handle better, these crossmembers are for you!

FCM-RCF1-350	1967-69 TH350, TH200, Muncie, Powerglide, T10, Saginaw	235.99 ea.
FCM-RCF1-400	1967-69 200R4, TH400 Short Tail.....	235.99 ea.
FCM-RCF1-700	1967-69 700R4, 4L60, Early 4L60E.....	235.99 ea.
FCM-RCF1-4L80	1967-69 4L80E, 4L85E	290.99 ea.
FCM-RCF1-T56	1967-69 GM T-56 (from a 93-97 F-body).....	235.99 ea.
FCM-RCF2E-350	1970-74 TH350, TH200, Muncie, Powerglide, T10, Saginaw.....	235.99 ea.
FCM-RCF2E-400	1970-74 200R4, TH400 Short Tail.....	235.99 ea.
FCM-RCF2E-700	1970-74 700R4, 4L60, Early 4L60E.....	235.99 ea.
FCM-RCF2L-350	1975-81 TH350, TH200, Muncie, Powerglide, T10, Saginaw.....	235.99 ea.
FCM-RCF2L-400	1975-81 200R4, TH400 Short Tail	235.99 ea.
FCM-RCF2L-700	1975-81 700R4, 4L60, Early 4L60E.....	235.99 ea.
FCM-RCF2L-4L80	1975-81 4L80E, 4L85E	290.99 ea.
FCM-RCF2L-T56	1975-81 GM T-56 (from a 93-97 F-body).....	235.99 ea.

Note: Energy Suspension mounts are required with all GForce crossmembers. No Volume Discount

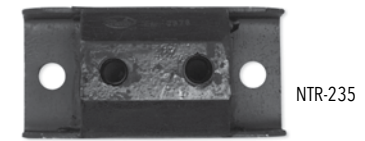

Transmission Mounts

NPG-100	All Powerglide.....	11.95 ea.
NTR-235	All TH350/ Manual.....	13.95 ea.
NTR-225	All TH400	13.95 ea.
BTE-7939	Mounting Bolt.....	0.95 ea.



Hurst Transmission Swap Crossmembers

These ultra-trick Hurst transmission cross-members have painstakingly been designed and fabricated from thick steel plate and heavy gauge steel tubing for a perfect fit and finish that has no equal. These bolt-in units are much stronger than the factory stock crossmembers and help maintain the correct transmission and driveshaft angle. Precision cut and fully mig-welded, then given a durable black powder coating finish to last a lifetime and give you peace of mind knowing you're buying the best parts available for your tremec TKO 5-Speed or Magnum 6-Speed conversions. You can surely trust the company that originally started out making conversion mounts back in 1958, Hurst Performance.

HURST-67510014	67-69 Magnum 6 Speed LS w/ Small Block Engine Mounts.....	328.99 ea.
HURST-67510002	67-69 Magnum 6 Speed LS w/ Big Block Engine Mounts.....	328.99 ea.
HURST-67510008	67-69 TKO 5-6 Speed w/ Small Block Engine Mounts	305.99 ea.
HURST-67510013	67-69 TKO 5-6 Speed w/ Big Block Engine Mounts	380.99 ea.
HURST-67510015	70-74 Magnum 6 Speed LS Swap	328.99 ea.
HURST-67510011	70-74 Magnum 6 Speed LS Swap	387.99 ea.
HURST-67510001	75-81 Magnum 6 Speed LS Swap	316.99 ea.
HURST-67510012	75-81 Magnum 6 Speed LS Swap	339.99 ea.

No volume discount.



Poly Graphite Transmission Mount

Poly mounts outlast OEM mounts and are able to absorb most driveline vibrations.

Add G to the part number for black. Add R to part number for red. Example: 3-1110G is for 82-83 in black.

3-1108G	1967-92 All	34.99 ea.
---------	-------------------	-----------

Torque Arm To Transmission Bushings

3-1110_	1982-83 All	18.95 ea.
3-1112_	1984-92 Lips toward drive shaft	18.99 ea.
3-1111_	1984-92 Lips away from drive shaft.....	18.99 ea.
3-1111_	1993-02 All	18.99 ea.



Brake Pads & Trim

OE style reproduction pads with correct ribs and medallions where applicable.

IHQ-236	All Auto Drum 6.5".....	4.99 ea.
IHQ-0163	All Auto Disc 6.5".....	9.99 ea.
IBB-8683	Auto Brake Trim.....	5.99 ea.
IHQ-0191	4 Speed Drum Brake.....	4.95 ea.
IHQ-0120	4 Speed Disc Brake.....	11.99 ea.
IHQ-0192	4 Speed Trim.....	5.99 ea.
IHQ-99F	1972-81 Small Clutch.....	9.95 ea.
IHQ-0125	1972-81 4 Speed W/Disc Brake.....	9.95 ea.



Transmission Cooler Lines

New OE style reproduction transmission cooling lines with flared ends and correct nuts.

		OM	SS
FTC6701	1967-69 Powerglide.....	50.99 ea.	77.99 ea.
FTC6703	1967-69 TH350.....	50.99 ea.	77.99 ea.
FTC6705	1967-69 TH400.....	50.99 ea.	77.99 ea.
FTC6708	1967-69 TH700-R4.....	50.99 ea.	77.99 ea.
FTC7005	1970-74 TH350.....	50.99 ea.	77.99 ea.
FTC7005	1970-74 TH350 1/2 Rad Fitting.....	50.99 ea.	77.99 ea.
FTC7006	1970-74 TH400 5/8 Rad Fitting.....	50.99 ea.	77.99 ea.
FTC8003	1974-81 TH350.....	50.99 ea.	77.99 ea.

Ships Oversize

Transmission Vacuum Lines

New OE style reproduction transmission vacuum lines with flared ends.

		OM	SS
FTV6701	1967-69 Powerglide.....	30.99 ea.	41.99 ea.
FTV6703	1967-68 TH350 LH Modulator.....	30.99 ea.	41.99 ea.
FTV6903	1967-69 TH350 RH Modulator.....	30.99 ea.	41.99 ea.
FTV6705	1967-69 TH400.....	30.99 ea.	41.99 ea.
FTV7005	1970-74 TH400.....	30.99 ea.	49.99 ea.
FTV7401	1974 Z/28.....	29.99 ea.	41.99 ea.
FTV7801	1978-81 TH350.....	29.99 ea.	41.99 ea.

Ships Oversize



Modulator Valve

Replacement modulator valve for automatic transmission.

FTM-12903	PG, TH350, TH400.....	39.95 ea.
-----------	-----------------------	-----------

Note: Smaller than original but functions the same.



Kickdown Cable & Bracket

Correct kickdown cable and bracket for cars with a TH350 transmission.

S530KIT	All TH350 Cable/Bracket.....	32.31 kit
S530	All TH350 Cable.....	20.95 ea.
S531	All TH350 Bracket.....	14.95 ea.



Cable Mounting Bracket

Correct bracket for mounting cable to transmission.

FCB-1210	1968-72 TH350.....	19.99 ea.
FCB-220	1968-72 TH400.....	19.99 ea.
FCB-193	1973-74 TH400.....	35.99 ea.



Shifter Cable Lever Brackets

Correct cable lever brackets which mount to transmission.

FCB-322	1968-69 1st Design.....	19.99 ea.
FCB-222	1970-72 2nd Design.....	24.95 ea.



Shifter Cable Stud

Correct cable stud which mounts to bracket.

FTH-050	Mounting Stud (to bracket).....	9.99 ea.
---------	---------------------------------	----------



Shifter Cables

Original GM or high quality reproduction shifter cables for floor mounted TH shifter.

FTH-973R	1968-72.....	28.95 ea.
FTH-973	1968-72 GM.....	94.95 ea.
FTH-773	1973-81.....	29.99 ea.



Shifter Cable Clip

Correct gold clip for mounting cable.

EBC-22	Mounting Clip.....	2.99 ea.
--------	--------------------	----------



Shifter Cable Clip

Correct push on clip which mounts to shifter.

FTH-049	Push on Clip (to shifter).....	7.99 ea.
---------	--------------------------------	----------



Clutch Pedal Booster Rod & Clip

For use with power disc brakes.

FBC-799	Booster Rod Clip.....	6.99 ea.
FBF-606	Booster Rod Fork.....	14.95 ea.



Column Shift Transmission Bracket

Correct column shift transmission bracket which mounts on all column shift GM cars from 1969-1979.

FTB-13433	1969-79.....	11.95 ea.
-----------	--------------	-----------

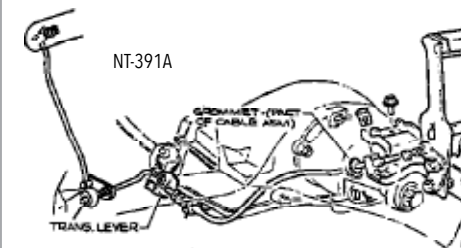

Back Drive Components

Correct bracket, spring, nylon bushing and mounting bolts that mount to the driver's side frame rail. Provides a pivot point for the automatic on the column shift linkage.

NT-391A	1969-72 Complete Kit.....	27.95 kit
NT-2833	1969-72 Bracket Only.....	16.95 ea.
NT-69BU	1969-72 Bushing Only.....	5.95 ea.
FB-69SP	1969-72 Back Drive Spring.....	5.95 ea.

Column Shift Linkage and Lockout Swivel Assembly

Correct swivel assembly for automatic column shift linkage and lockout.

FSA-ZRLOS 1967-81 19.95 ea.

FCR-3920215

FCR-3914805

Steering Column Rods

FCR-3920215 1967-69 Upper PG 19.95 ea.
 FCR-3972257 1967-69 Upper TH350/TH400 19.95 ea.
 FCR-3945511 1968-69 Lower TH350 19.95 ea.
 FCR-3914805 1967-69 Lower TH400 19.95 ea.
 FCR-3895294 1967-68 Lower PG 18.95 ea.
 FCR-3939743 1969 Lower PG 19.95 ea.

Driveshaft Yokes

New front drive shaft yokes.

FY-123 Front Yoke TH400 99.99 ea.
 FY-123 Front Yoke 1971-72 M22 99.99 ea.
 FY-935 Front Yoke TH350/4 spd 99.95 ea.

Tail Seals

Correct tail shaft yoke seals.

FTS-PG Powerglide 5.95 ea.
 FTS-350 TH350 5.95 ea.
 FTS-400 TH400 10.95 ea.

Tail Shaft Bolts

Correct TR head markings & black phosphate plating.

BSB-12925 PG, TH350, TH400 6pc 9.95 kit

U Joint Attaching Kits

Correct straps and bolts for attaching drive shaft to rear yoke.

BPU-337 All Straps with Bolts 15.99 kit
 BPU-334 All U Bolts with Nuts 16.99 kit



FSA-ZRLOS



Rear Axle Yokes

New rear differential yokes.

FY-2122 Strap Type 114.95 ea.



BM-70500

B&M Differential Covers

B&M Cast Aluminum Differential Covers are designed to strengthen the differential by preventing case distortion, ring gear & bearing cap deflection. Constructed of A356.0-T6 aluminum, these rugged covers significantly increase the fluid capacity and dissipate heat much faster than the stock factory unit to prolong the life of your ring and pinion gears.

BM-70500 12 Bolt 8.875" Ring Gear Silver 194.99 ea.
 BM-70502 10 Bolt 8.2,5, or 6" Ring Gear Silver 198.99 ea.
 BM-71502 10 Bolt 8.2,5, or 6" Ring Gear Black 216.99 ea.
 BM-70503 10 Bolt 8.2" BOP Ring Gear Silver 177.99 ea.
 No volume discount.



GCS-R0002X



GCS-S4787

Custom Rear End Covers

Choose from high quality chrome or bright polished aluminum. A great finishing touch!

GCS-S4787 12 Bolt Chrome 13.59 ea.
 GCS-S5082 12 Bolt Polished 76.49 ea.
 GCS-R0002X Bolt Kit 8.99 kit

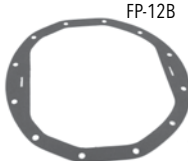

FP-12B



NP-109

Rear End Cover

OE style reproduction rear end covers.

NP-109 12 Bolt Cover 49.95 ea.
 FP-10B 10 Bolt Gasket 6.95 ea.
 FP-12B 12 Bolt Gasket 6.95 ea.
 BRE-2008 Cover Bolt 0.95 ea.

FPF-49



FPF-668



Rear End Fluid

AC Delco rear end fluid and posi additive.

FPF-668 Rear End Fluid 24.95 ea.
 FPF-49 Posi Additive 14.95 ea.

Typical GM rear ends require 1 bottle of additive and 3 bottles of fluid.

FY-2122



TTP-68



TTP-71



TTP-70



TTP-6972



Turbo HydraMatic Transmission ID Tags

Turbo HydraMatic transmission ID tag with rivet, measuring 1-1/8 inch x 1-15/16 inch. This installs on the side of the transmission case with the rivet. You must punch your own info onto the tag.

TTP-68 1968 Dark Olive 29.95 ea.
 TTP-6972 1969 & 72 Yellow 29.95 ea.
 TTP-70 1970 Black 29.95 ea.
 TTP-71 1971 Light Blue 29.95 ea.



HBB-5847



FDP-3R



FPT-3



FDP-5R



N-7081

Rear End Plugs & Posi Tag

OE style reproduction plugs and posi tag.

HBB-5847 All Metal Tag 6.95 ea.
 FDP-5R 1967-68 Plug 1" 16.95 ea.
 FPT-3 1967-68 Posi Tag 1" 12.95 ea.
 FDP-3R 1969-72 Plug 3/4" 16.95 ea.
 FPT-1 1969-72 Posi Tag 3/4" 12.95 ea.
 N-7081 1967-72 Vent Plug 9.95 ea.



TCS Wire Retainer

Correct reproduction for Muncie.

ATS-653 1970-74 w/ Muncie 19.95 ea.



ATS-21MP



ATS-21MS

TCS Transmission Switches

Correct TCS switch located on transmission.

ATS-21MP 1970-75 Pin Style 32.95 ea.
 ATS-21MS 1970-75 Spade Style 32.95 ea.

Screw-On
up to 1968



Clip-On
1969 & up



Speedometer Cables

New complete cables with casings and correct ends ready to install.

1967-68 Cables came with screw on fittings on both ends.

1969 and up cables had a screw end on the transmission and a clip on end on the speedometer.

Check your speedometer fitting and length before ordering.

FCC-006	1967-68 38" Upper (Screw On).....	18.95 ea.
FCC-201	1967-68 64" LH (Screw On).....	18.95 ea.
FCC-203	1967-68 83" RH (Screw On).....	18.95 ea.
FCC-202	1969-92 100" (Clip On).....	18.95 ea.
FCC-205	1969-92 80" (Clip On).....	18.95 ea.
FCC-305	1969-92 61" (Clip On).....	18.95 ea.
FCC-309	1969-92 41" (Clip On).....	18.95 ea.
FSG-100	1967-69 Grommet.....	6.95 ea.

Longer cables are for cars with a RH passenger side speedometer drive on the transmission.



FCA-877

Speedometer Cable Assembly

Manufactured to OE style original specifications, these assemblies come complete with a high quality firewall grommet already installed to save time and hassles.

FCA-870	1967-68 58".....	32.99 ea.
FCA-871	1967-68 69".....	32.99 ea.
FCA-872	1967-68 73".....	32.99 ea.
FCA-874	1967-68 Upper 37.5".....	32.99 ea.
FCA-876	1969 62".....	36.99 ea.
FCA-877	1969 71".....	32.99 ea.



IRC-006

Speedometer Cable Retaining Clip

Holds the cable to the back of speedometer.

IRC-006	1969-81 All.....	5.99 ea.
---------	------------------	----------



FSG-100

Speedometer Cable Grommet

Correct rubber seal for firewall.

FSG-100	1967-69 All.....	6.95 ea.
FSG-22	1970-81 All.....	7.95 ea.



FSP-10

Speedometer Cable Plug

For 4 Speed Muncie only.

FSP-10	All.....	1.95 ea.
--------	----------	----------



FHB-115

Speedometer Cable Clip

OE style reproduction of the speedometer cable clip that mounts on the firewall and transmission hump.

FHB-115	1967-69 All.....	11.95 ea.
---------	------------------	-----------



6454841



3954257

Speed Warning Indicator Cables

This high quality reproduction speed warning cable was originally found on cars with RPO code U15 (speed warning indicator).

6454841	1967-68 All.....	29.99 ea.
6476813	1969 All.....	29.99 ea.
3954257	1969 Cable Bracket.....	29.99 pr.



FHB-13653

Speedometer Cable Clip

Bolts to the bottom of the transmission tail shaft bolt to keep the speedometer cable from hanging down.

FHB-13653	1970-79.....	14.95 ea.
-----------	--------------	-----------



1993413

Reverse Lamp Switch

Correct switch assembly for activating reverse lamps.

1993413	1967-68 w/ Muncie.....	74.99 ea.
GNS-33	1969-73 4 Speed.....	49.99 ea.



10665

Reverse Switch Extension Harness

Correct harness which plugs into firewall.

10665	1967-68.....	23.99 ea.
-------	--------------	-----------

BUY 'N SAVE WITH KITS



REVSKIT-67F

Reverse Switch Kit

This kit includes all components needed for a complete installation: Switch, extension harness, bracket, shield and rod.

REVSKIT-67F	1967-68.....	127.74 kit
-------------	--------------	------------

No Volume Discount

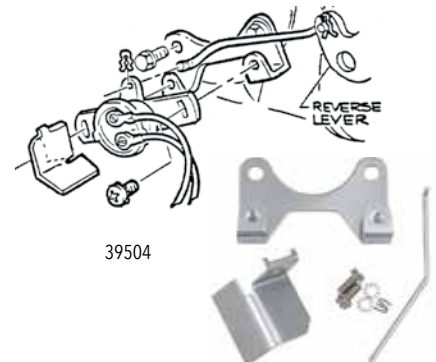

39504

Reverse Switch Mounting Kit

Complete with bracket, shield, rod, clips and hardware for mounting the reverse switch.

39504	1967-68 Complete.....	42.95 kit
GRB-342	1967-68 Bracket Only.....	14.95 ea.
GWT-17	1967-68 Shield Only.....	9.95 ea.
GRR-58	1967-68 Rod/Clips Only.....	17.95 ea.



GNS-1969

Neutral Start Switches

Correct safety switch located at the pedal to prevent the car from starting in gear.

GNS-1969	1969 Manual.....	59.95 ea.
FSR-372	Switch Rod & Clip.....	16.99 ea.



GNS-23

Neutral Start/Reverse Lamp Switch

Correct switch for proper engine and reverse light activation.

GNQ-375	1967 Console.....	39.99 ea.
GNS-23	1967-68 TH350/TH400.....	21.99 ea.
GDR-411	1969-73 Automatic.....	21.95 ea.

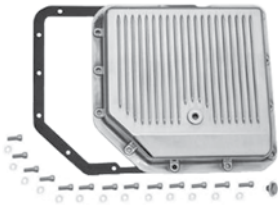

GCS-S8491

Polished Finned Transmission Pans

Show quality polished stock depth pan crafted from cast aluminum and polished to a bright finish. Includes gasket, drain plug and bolts.

GCS-S8491	TH35042.39 ea.
GCS-S8492	TH40050.39 ea.
GCS-S8493	TH700-R462.99 ea.



GCS-S9074

Chrome Transmission Pans

Stock depth. Chrome plated steel for a show quality finish.

GCS-S9074	TH35015.99 ea.
GCS-S7599	TH700-R424.99 ea.



GCS-S9124

Chrome Finned Transmission Pans

Stock depth. Chrome plated steel with fins.

GCS-S9124	Powerglide15.99 ea.
GCS-S9122	TH35014.39 ea.
GCS-S9121	TH40014.39 ea.
GCS-S9712	TH700-R419.99 ea.

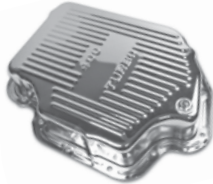

GCS-S9197

Extra Capacity Chrome Finned Transmission Pans

Same quality show finish as our stock pans but with extra fluid capacity for better cooling.

GCS-S9197	1.5 Extra Qts TH40016.79 ea.
GCS-S9196	2.5 Extra Qts TH40028.99 ea.

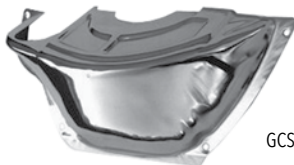

GCS-S9417

Custom Flywheel Inspection Covers

Looks great on any show car!

GCS-S9417	PG Chrome21.59 ea.
GCS-S8607	TH350/TH400 Polished38.39 ea.
GCS-S9588	TH350/TH400 Chrome18.89 ea.
GCS-S9587	TH700-R4 Chrome22.39 ea.



B&M Deep Transmission Pan Cast

These B&M automatic transmission deep pans provide additional fluid capacity and cooling ability. No modifications to the dipstick are needed. They include a drain plug for clean and easy fluid changes. Adds 2-3 quarts to the Transmission.

BM-30280	All TH350, TH250 3Qts186.99 ea.
BM-20280	All TH400 2Qts169.99 ea.
BM-70280	All Powerglide 2Qts180.99 ea.
BM-70260	All TH700RH, 4L60/65E 3Qts259.99 ea.

No volume discount.



FDT-350

Dipstick & Tubes

GM replacement dipstick and tubes.

FDT-350	TH350 Tube21.95 ea.
FDT-400	TH400 Tube21.95 ea.
FDS-3	TH350 Stick9.95 ea.
FDS-4	TH400 Stick9.95 ea.



GCS-S9422

Chrome Dipsticks and Tubes

Show quality dipsticks are an excellent upgrade to any engine compartment. Includes dipstick & tube.

GCS-S9422	Powerglide11.19 ea.
GCS-S9421	TH35010.39 ea.
GCS-S9421BA	TH350 Billet Handle17.59 ea.
GCS-S4994	TH350 34"13.99 ea.
GCS-S4994BA	TH350 34" Billet Handle17.99 ea.
GCS-S4995	TH400 24"9.34 ea.
GCS-S4995BA	TH400 24" Billet Handle11.99 ea.



GCS-S5004

Chrome Dipsticks w/ Braided Tubes

Stainless steel braided tube with chrome handle.

Bellhousing Mount

GCS-S5004	TH35036.54 ea.
GCS-S5005	TH40036.54 ea.
GCS-S5006	TH700-R434.39 ea.

Firewall Mount

GCS-S5104	TH350/TH400 29"41.64 ea.
GCS-S5106	TH700-R441.64 ea.



GCS-S6053

Stainless Steel Kickdown Cables

Show quality look with more adjustability than your factory cable.

GCS-S6053	TH35041.99 ea.
GCS-S6051	TH700-R444.99 ea.

Note: For carburetor applications only.



Muncie M20, M21, M22

TH350, TH400

Transmission Speedometer Gears

These are the correct speedometer drive gears which go inside the transmission case. Please compare the gear you have to what you are ordering as the color or tooth count may vary from original. We do not have an application chart for these, so if changing axle ratios or tire size, please consult various online resources.

Muncie M20, M21, M22,

Saginaw 3 & 4 Speed and Powerglide

FR-158RB	17 Tooth Purple16.95 ea.
FR-158RD	18 Tooth Brown16.95 ea.
FR-158RF	19 Tooth Natural16.95 ea.
FR-158RH	20 Tooth Blue16.95 ea.
FR-158RK	21 Tooth Red16.95 ea.
FR-158RM	22 Tooth Gray16.95 ea.
FR-158RS	23 Tooth Black16.95 ea.
FR-158RV	24 Tooth Orange16.95 ea.

TH350, TH375, TH400, TH475

FR-158SB	35 Tooth Pink16.95 ea.
FR-158SD	36 Tooth White16.95 ea.
FR-158SF	37 Tooth Red19.95 ea.
FR-158SH	38 Tooth Blue16.95 ea.
FR-158SM	40 Tooth Black16.95 ea.
FR-158SP	41 Tooth Yellow16.95 ea.
FR-158SS	42 Tooth Green16.95 ea.
FR-158SV	43 Tooth Purple16.95 ea.
FR-158SX	44 Tooth Dark Gray16.95 ea.
FR-158SZ	45 Tooth Light Blue16.95 ea.



BM-70264

B&M Transmission Coolers & Kits

B&M Super Coolers are 100% aluminum stacked plate style core which is ideal for additional transmission cooling. With oven brazed construction this sturdy cooler design is practically impervious to flying rocks or other debris.

Small

BM-70265	All 7,500 BTU Polished97.99 ea.
BM-70273	All 15,000 BTU Black89.99 ea.

Medium

BM-70268	All 13,000 BTU Black90.99 kit
BM-70266	All 20,500 BTU Black121.99 ea.
BM-70272	All 20,500 BTU Polished166.99 ea.

Large

BM-70264	All 14,400 BTU Black105.99 kit
BM-70274	All 29,200 BTU Black147.99 ea.

No volume discount.



BM-70298

B&M HiTek Cooling Systems

Hi-Tek Super Coolers are fitted with a high quality 12 Volt cooling. Suitable for many fluids including ATF, engine oil, differential oil and power steering fluid.

BM-70298	All 350 CFM Black330.99 ea.
BM-70297	All 590 CFM Black364.99 ea.

No volume discount.

Centerforce Clutches & Flywheels

Whether you are building a street cruiser or a high powered drag race car, Centerforce clutches and flywheels will get you down the road reliably. With kits ranging from your basic entry-level performance clutch, to their radical twin disc kits, Centerforce offers the kit for you.

Steel Flywheels

Centerforce steel flywheels are manufactured from high quality billet steel and match closely to the original equipment flywheel weight. Please make sure to double check application before ordering.

700120	11" 168 Tooth, Internally Balanced Engines 454 BB 33 in/oz	298.99 ea.
700140	11" 168 Tooth, Externally Balanced Engines	381.99 ea.

Flywheels for externally balanced engines have a 23.4 in/oz. counter balance.

Centerforce I Clutch Kits

The Centerforce 1 Clutch Series is designed as a high-quality entry-level performance clutch for those in need of a superior stock replacement. Please make sure to double check application before ordering.

KCF523516	1966-70 396ci, 168 Tooth, 11" Clutch, 10 Spline	334.99 kit
KCF523516	1967-70 350ci, 168 Tooth, 11" Clutch, 10 Spline	334.99 kit
KCF523516	1970 400ci, 168 Tooth, 11" Clutch, 10 Spline	334.99 kit
KCF523516	1972 402ci 168 Tooth, 11" Clutch, 10 Spline	334.99 kit

Centerforce II Clutch Kits

The Centerforce II Clutch Series utilizes a full facing disc with premium friction materials and a pressure plate with patented centrifugal weights (where applicable). Furthermore, static clamp load is increased via a patented machining processes; this combination allows superb holding power and maximum clutch life, making this clutch ideal for selected street/strip applications. Please make sure to double check application before ordering.

KCFT355216	1966-70 396ci, 168 Tooth, 11" Clutch, 10 Spline.....	404.99 kit
KCFT355216	1967-70 350ci, 168 Tooth, 11" Clutch, 10 Spline	404.99 kit
KCFT355216	1970 400ci, 168 Tooth, 11" Clutch, 10 Spline	404.99 kit
KCFT355216	1972 402ci, 168 Tooth, 11" Clutch, 10 Spline.....	404.99 kit



KCFT355216



N1716

Centerforce Accessories

N1716	Throw-out Bearing, All	47.99 ea.
-------	------------------------------	-----------

HAYS-92-1003

Hays Manual Clutches

Hays Street 450 single disc kits are an excellent upgrade offering up to 30% more holding power over your stock clutch. Designed to handle stock to mildly modified engines up to 450 horsepower. This is a great clutch where drivability is the most important factor along with a stock pedal feel.

HAYS-91-1003	10.5" 26 Spline	289.99 kit
HAYS-91-1002	10.5" 10 Spline	286.99 kit
HAYS-91-1004	11" 10 Spline	296.99 kit
HAYS-91-1005	11" 26 Spline	296.99 kit

Hays Street 650 single disc kits are designed to handle highly modified naturally aspirated engines up to 650 horsepower. Designed as a true street/strip clutch for spirited high performance driving or frequent track use.

HAYS-92-1003	10.5" 26 Spline	574.99 kit
HAYS-92-1002	10.5" 10 Spline	553.99 kit
HAYS-92-1004	11" 10 Spline	589.99 kit
HAYS-92-1005	11" 26 Spline	584.99 kit

No volume discount.

Lakewood Bellhousing

The Lakewood 15000LKW bellhousing connects Chevy small and big block engines to transmissions utilizing the standard GM pattern such as the Muncie, Saginaw, Borg Warner T10 and Tremec TKO transmissions. This bellhousing is hydro formed to fit '58-'87 GM full and midsize cars, 67-81 F-body vehicles and 68-79 Novas. This bellhousing is S.F.I. 6.1 certified which is required by many sanctioning bodies for cars running 11.49 or faster in the quarter mile. The Lakewood 15000 comes complete with engine block plate and Grade 8 mounting hardware.

LW-15000LKW	1967-1981 SBC, BBC	524.99 ea.
FEH-397	1967-1981 All Resto Clutch Fork.....	52.99 ea.
FKW-4999	1967-1981 All Clutch Fork Boot.....	8.95 ea.
FKW-11LW	1967-1981 All Clutch Fork Boot.....	30.99 ea.
FTE-9000-ADJ	1967-1981 All Adjustable Clutch Fork Ball	29.95 ea.

No volume discount.



LW-15000LKW

FKW-11LW

FKW-4999

FEH-397



HAYS-10-010



Hays Automatic Flexplate

Hays heavy duty Flexplate for high performance competition Chevy engines are constructed of a thicker than stock steel plate. This enables them to withstand the stress of high-stall torque converters and high-RPM engines. These flexplates are supplied with a ring gear that is securely welded in place and feature a dual bolt pattern for use with a Powerglide or Turbo style torque converter.

HAYS-10-010	168t 57-85 SBC 65-70 BBC*	95.99 ea.
HAYS-10-020	168t SBC 70-90 BBC**.....	89.99 ea.

*Internally balanced. **Externally balanced.
No volume discount.



BM-20230



B&M Automatic Flexplate

Heavy duty flexplate for extreme racing or street applications. SFI certified for NHRA & IHRA.

BM-20230	55-85 168t SBC up to 1991 BBC 109.99 ea.	
BM-20232	55-85 168t SBC 400	117.99 ea.
BM-20233	55-85 168t BBC 454	106.99 ea.
BM-20232	55-85 153t SBC.....	117.99 ea.

*Except SBC 400 and BBC 454. No volume discount.





XT-67KUS



BUY'N SAVE
WITH KITS

Fuel Tank Super Kits

If your original tank & hardware has seen better days, you can replace everything in one shot with this complete kit! We give you the choice of a beautiful OEM tank (made in North America) for the ultimate in show quality or an IMPROVED QUALITY import tank. Both tanks are galvanized. Each kit includes (1) tank, (1) tank to filler neck (1967-68 only), (1) upper neck (1967-68), (1) neck sleeve, (1) anti-squeak kit, (1) bolt kit, (1) lock ring and (1) o-ring gasket.

OEM		Import	
XT-67KUS	1967-68 All229.02 kit	XT-67KI	1967-68 All223.90 kit
XT-69KUS	1969 All165.06 kit	XT-69KI	1969 All151.95 kit
			<i>No Volume Discount. Ships Oversize 2.</i>

1967-81 Sniper Fuel Injection Fuel Tanks



Converting the carbureted fuel system on your car or truck over to EFI can be a daunting task. We have made this conversion easy with our complete tank and fuel system kits! When converting to EFI, it is crucial that you do not contaminate your new parts with dirt, rust, and sludge from an old fuel tank. Sniper fuel tanks are designed to meet or exceed the quality of your factory fuel tank. Sniper tanks are made from steel with a galvanized finish that are manufactured to the OEM specifications. Narrow corner tanks offer more room for large tire combos.

Tank With Pump & Sender Stock Width

HOL-19-100	1967-68* 550HP	549.99 ea.
HOL-19-400	1967-68* 750HP	599.99 ea.
HOL-19-104	1969** 550HP	549.99 ea.
HOL-19-404	1969** 750HP	599.99 ea.

HOL-19-100



Tank With Pump & Sender Narrow Corners

HOL-19-101	1967-68* 550HP	599.99 ea.
HOL-19-401	1967-68* 750HP	649.99 ea.
HOL-19-103	1969** 550HP	599.99 ea.
HOL-19-403	1969** 750HP	649.99 ea.

Install Kit (hose, filter & fittings)

HOL-526-10	Universal For EFI	237.99 ea.
------------	-------------------------	------------

Hose clamps are not included with kits with 2 piece filler necks.

*Steel filler neck that extends to rear valance is not included. You must use your existing stock filler neck or purchase a new one. **You may have to switch to the shallow reach gas cap 1.25 inch depending on your application. *No volume discount. Ships oversize. Not eligible for free shipping.*



XT-67F

OEM Fuel Tanks

When you want the highest quality original style fuel tank, look no further than Ground Up's line of OEM fuel tanks! Made in North America, these fuel tanks are galvanized as original and are perfect for your show car.

XT-67F	1967-68 All (18 gal.).....	139.99 ea.
XT-69F	1969 All (18 gal.).....	139.99 ea.
XT-70F	1970 w/o EEC (18 gal.).....	199.99 ea.
XT-71F	1970-73 w/ EEC (18 gal.).....	199.99 ea.
XT-74F	1974-77 All (21 gal.).....	199.99 ea.
XT-78F	1978-81 All (21 gal.).....	199.99 ea.

1969 includes filler neck. *Ships Oversize 2.*

XT-67X



XTS-69X

Stainless Steel Fuel Tanks

These stainless steel fuel tanks are shiny enough for any show car and rust proof enough for any daily driver! Installation is easy because this tank is a direct bolt in replacement for your OEM tank.

XTS-67F	1967-68 All	239.99 ea.
XTS-69F	1969 All	239.99 ea.
XTS-70F	1970-73 w/o EEC	239.99 ea.
XTS-71F	1970-73 w/ EEC	239.99 ea.
XTS-74F	1974-77	239.99 ea.
XTS-78F	1978-81	239.99 ea.

Ships Oversize 2



XT-69K-SS

Stainless Fuel Tank Super Kits

These stainless tank kits will probably outlast your car and still look very close to OEM. Each kit includes (1) tank, (1) tank to filler neck (1967-68 only), (1) upper neck (1967-68), (1) neck sleeve, (1) anti-squeak kit, (1) bolt kit, (1) lock ring and (1) o-ring gasket.

XT-67K-SS	1967-68 All	335.06 kit
XT-69K-SS	1969 All	266.34 kit

No Volume Discount. Ships Oversize 2.



TANK-3

Fuel Tank Mounting Kit

If your tank is good but you need to replace your hardware, this complete kit has it all! Includes straps, insulation and all hardware.

TANK-3	1967-69 All	36.46 kit
--------	-------------------	-----------



Fuel Tank Straps

OE style reproduction fuel tank straps.

XTS-679	1967-69	19.95 pr.
XTS-703	1970-73	19.99 pr.
XTS-768	1974-81	24.99 pr.
4022-749-82P	1982-92	23.95 pr.

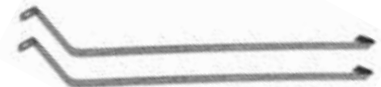

Stainless Steel Fuel Tank Straps

Perfect for your new stainless steel tank!

XTS-F67S	1967-69	39.99 pr.
XTS-F70S	1970-73	39.99 pr.
XTS-F768S	1974-81	44.95 pr.



Fuel Tank Hardware

Correct OEM bolts and clips for mounting fuel tank as original.

BCI-4753	1967-69 All	8.95 kit
----------	-------------------	----------

NH-4381

Fuel Tank Insulation

Correct foam insulation which is glued to the top of the fuel tank to prevent squeaks and rattles, and tar paper which goes between the tank and the straps.

NH-4381	1967-81	13.99 kit
NH-UNI	1967-01 Universal 36" x 21"	19.99 ea.



Fuel Tank Caps

OE style reproduction fuel tank caps with correct logos.

XTC-043	1967-68 Paintable.....	22.95 ea.
XTC-045	1967-68 SS.....	40.99 ea.
XTC-059	1967 SS 350.....	40.99 ea.
XTC-057	1967-68 RS.....	42.99 ea.
XTC-250	1967-68 Bowtie.....	37.99 ea.
XTC-149	1969-70 Short Cam.....	11.95 ea.
XTC-807	1971-74 Long Cam.....	16.99 ea.
XTC-817	1975-81 Non Vented.....	9.95 ea.
XTC-819	1975-81 Vented.....	12.95 ea.



1967-68 Steel Filler Neck

OE style reproduction fuel filler neck assembly.

XN-113	1967-68 All.....	39.99 ea.
--------	------------------	-----------



1967-68 Filler Neck Sleeve

Correct rubber sleeve that covers the fuel filler neck assembly.

XNS-517	1967-68 All.....	22.99 ea.
---------	------------------	-----------



1967-68 Filler Neck Hose

Correct fuel filler neck hose.

XNH-40	1967-68 All.....	9.99 ea.
--------	------------------	----------



1967-68 Filler Neck Hose Clamp

Correct OEM clamp for filler neck hose.

XNC-300	1967-68 All.....	3.99 ea.
---------	------------------	----------



Fuel Tank Doors

Correct spring loaded fuel tank door.

XTD-1630	1969 Door.....	22.95 ea.
XTD-344	1970-77 Door.....	22.95 ea.
XTD-10B	Door Bumper.....	1.95 ea.
BTB-56	Door Bolt/Nut.....	1.25 ea.
BPA-53K	1967-81 Plate To Bracket Hardware.....	3.95 kit



Fuel Tank Sending Units

Original GM or OE style reproduction sending units.

XSU-016	1967-69 3/8" GM.....	194.99 ea.
XSU-19	1967-69 3/8" Repro.....	34.99 ea.
XSU-93	1967-69 3/8" w/ 1/4" Return Repro.....	34.99 ea.
XSU-848	1970-73 3/8" Repro.....	59.99 ea.
XSU-846	1970-73 3/8" w/ 1/4" Return Repro.....	46.95 ea.
XSU-741	1974-81 3/8".....	45.99 ea.
XSU-742	1974-81 3/8" w/ 1/4" Return.....	45.99 ea.
DSE080201	0-90 Ohm Sending Unit for DSE Tank.....	51.99 ea.

No Volume Discount on GM.



Sender Filter

Correct mesh filter to keep debris out.

XFF-092	All 3/8".....	17.95 ea.
---------	---------------	-----------



Sending Unit Lock Rings

Correct locking rings used to secure the sending unit to the tank.

XLR-937	1967-69 w/ Gasket.....	5.95 ea.
XLR-999	1970-73 w/ Gasket.....	5.95 ea.
XLR-7481	1974-81 w/ Gasket.....	5.95 ea.



Sending Unit Harness

New OE style reproduction with correct boot.

18915	1967-68 All.....	16.99 ea.
18910	1969 All.....	16.99 ea.
33825	1970-71 All.....	16.99 ea.
33835	1972-73 All.....	17.99 ea.
36272	1974-77 All.....	17.99 ea.
36269	1978-80 All.....	23.99 ea.



Fuel Tank Hose Kits

Correct GM style hose and pinch clamps.

AXP-3800	All 3/8".....	4.95 kit
AXP-1438	All 3/8" - 1/4".....	6.95 kit



Fuel Tank Vent

Correct fuel tank vent.

XTV-689	1968-70.....	39.95 ea.
---------	--------------	-----------



Fuel Line Clips

Correct clips for attaching fuel lines to frame.

ELC-1516	5/16" Line.....	3.99 ea.
ELC-516	5/16" w/ Tab.....	3.99 ea.
ELC-038	3/8" Line.....	4.99 ea.
ELC-038T	3/8" w/ Tab.....	3.95 ea.
ELC-1438	1/4" - 3/8" Line.....	4.99 ea.
ELC-1438T	1/4" - 3/8" w/ Tab.....	3.99 ea.
BLC-056	Correct Bolt.....	0.50 ea.
XLB-679	1967-69 Retainer at Rear Frame.....	15.95 ea.



Fuel Line Clip Kits

These convenient kits include all of the correct clips needed to install a set of factory fuel lines.

INL-CCF201	1967-68 7pc.....	22.95 kit
INL-CCF202	1969 w/o Return 7pc.....	20.95 kit
INL-CCF203	1969 w/ Return 7pc.....	26.95 kit
INL-CCF205	1970-71 3/8" w/o Return 10pc.....	26.95 kit
INL-CCF206	1970-71 3/8" w/ Return 10pc.....	36.95 kit
INL-CCF207	1972-77 3/8" w/o Return 10pc.....	28.95 kit
INL-CCF208	1972-77 3/8" w/ Return 10pc.....	36.95 kit
INL-CCF209	1978-81 3/8" w/ Return 10pc.....	36.95 kit

THE
RIGHT
Stuff

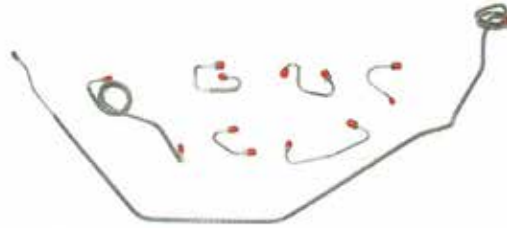

Fuel Lines Front to Rear

OE style reproduction pre-bent fuel lines featuring correct armor shielding and cloth insulation as original. Available in original material (OM) and stainless steel (SS).

Main Lines

	OM	SS
EGL6703	1967 V8 Small Block 3/8" (1pc.)	66.99 ea..... 103.99 ea.
EGL6704	1967 V8 Big Block 3/8" 1pc.	66.99 ea..... 103.99 ea.
EGL6701	1967-68 5/16" 1pc.	66.99 ea..... 103.99 ea.
EGL6803	1968 V8 Small Block 3/8" 1pc.	66.99 ea..... 103.99 ea.
EGL6805	1968 V8 Big Block 3/8" 1pc.	66.99 ea..... 103.99 ea.
EGL6905	1969 6 Cylinder 5/16" 1pc.	66.99 ea..... 103.99 ea.
EGL6907	1969 V8 All 3/8" 1pc.	66.99 ea..... 103.99 ea.
EGL7001	1970-73 3/8" 2pc.	66.99 ea..... 103.99 ea.
EGL7006	1970-74 6 Cylinder 3/8" 2pc.	66.99 ea..... 103.99 ea.
EGL7201	1972 396 3/8" 2pc.	66.99 ea..... 103.99 ea.
EGL7202	1972 396 1/4" Vapor Line 2pc.	66.99 ea..... 103.99 ea.
EGL7401	1974 3/8" 2pc.	66.99 ea..... 103.99 ea.
EGL7506	1975-76 3/8" 2pc.	66.99 ea..... 103.99 ea.
EGL7705	1977 Front 5/16" X-Over 1pc.	41.99 ea..... 51.99 ea.
EGL7704	1977 5/16" Vapor Line 1pc.	66.99 ea..... 103.99 ea.
EGL7801	1977-79 3/8" 2pc.	66.99 ea..... 103.99 ea.
EGL8001	1980-81 (except Z/28) 3/8" 2pc.	66.99 ea..... 103.99 ea.
EGL8005	1980-81 Z/28 only 3/8" 2pc.	66.99 ea..... 103.99 ea.

Ships Oversize 2.

Fuel Return Lines

	OM	SS
EGL6909	1969 V8 All 1/4" 1pc.	66.99 ea..... 103.99 ea.
EGL7002	1970-73 All 1/4" 2pc.	66.99 ea..... 103.99 ea.
EGL7402	1974 1/4" 2pc.	66.99 ea..... 103.99 ea.
EGL7504	1975-76 1/4" 2pc.	66.99 ea..... 103.99 ea.
EGL7802	1977-79 1/4" 2pc.	66.99 ea..... 103.99 ea.
EGL8002	1980-81 (except Z/28) 1/4" 2pc.	66.99 ea..... 103.99 ea.
EGL8006	1980-81 Z/28 1/4" 2pc.	66.99 ea..... 103.99 ea.

Ships Oversize 2.

Vapor Return Lines

	OM	SS
FEM04	1970-73 V8 4pc.	99.99 ea..... 143.99 ea.
FEM03	1970-74 6 cyl 1pc.	101.99 ea..... 144.99 ea.
FEM74	1974 V8 4pc.	101.99 ea..... 144.99 ea.
FEM05	1975-77 1pc.	101.99 ea..... 144.99 ea.
FEM08	1978 2pc.	101.99 ea..... 143.99 ea.
FEM10	1979-81 2pc.	101.99 ea..... 144.99 ea.

GM Restoration Parts

AXD-69



Exhaust Manifolds

New GM restoration manifolds. These brand new manifolds are sold in matched pairs and come with GM cast numbers. AXD-67 features alternator bracket provision as original for some cars.

AXD-67*	1967-68 SB non-SMOG	
	3840912 / 3892679	339.95 pr.
AXD-69**	1969-72 SB non-SMOG	
	3932376 / 3942529	359.95 pr.
AXD-69S	1969-72 SB w/ SMOG	
	3946826 / 3942527	379.95 pr.
AXD-396	BB non-SMOG	
	3916178 / 3909879	379.95 pr.
AXD-396S	BB w/ SMOG	
	3916178 / 3909879	379.95 pr.

*Features alternator mount provision. **Use for early cars without alternator mount provision. No volume discount. Ships Oversize.

OEM Exhaust Manifold Bolts

Correct head marked and colored bolts for mounting exhaust manifolds to block.

APB-1382	SB w/ Washers 24pc.	27.99 kit
APB-1821	BB Flanged Head 16pc.	23.99 kit
APB-3506	BB Loose Washer 32pc.	26.99 kit



ALI-2228

Exhaust Stud Kit

Steel studs for attaching pipe to manifolds.

ALI-2228	All V8	24.99 kit
----------	--------	-----------



EXL-200

Exhaust French Locks

This kit is a correct set of four stainless steel stamped french locks for corners of exhaust manifold as installed by factory.

EXL-100	1967-73 SB	14.95 kit
EXL-200	1967-73 BB	14.95 kit



Upper & Lower Heat Stove

Works in conjunction with the air heat tube to preheat the air cleaner thermo-sensor.

EHS-471	1969-76 Upper Heat Stove	9.99 ea.
EHS-473	1969-81 Lower Heat Stove	19.99 ea.
EHS-128	1968-81 Heat Riser Tube	13.95 ea.



AHR-1190

Heat Riser Valves

Correct valve for pre-heating engine on cold start.

AHR-1190	Valve SB 2"	49.95 ea.
AHR-1180	Valve BB 2.5"	69.99 ea.



N-660

Heat Riser Spacers

Takes the place of the heat riser for increased flow.

N-660	2" Spacer SB	54.95 ea.
N-733	2.5" Spacer BB	46.99 ea.



Exhaust Gaskets & Donuts

XG-20	Riser Gasket 2" SB	1.95 ea.
XG-225	Riser Gasket 2.5" BB	1.95 ea.
XD-400	Donut 2" SB	3.95 ea.
XD-500	Donut 2.5" BB	4.95 ea.
XE-152	Extension 2" SB	12.99 ea.
XE-153	Extension 2.5" BB	15.99 ea.



XSF-67

OEM Style Exhaust Systems

These complete aluminized exhaust systems are a perfect replacement for standard dual exhaust. All components are aluminized inside and out for long lasting beauty. Pipes are slightly polished giving a stainless steel-like appearance. Systems are available for big block and small block engines with or without resonators.

XSF-67	1967-68 SB 2".....	425.95 kit
XSF-67BB	1967-68 BB 2.5".....	425.95 kit
XSF-69	1969 SB 2".....	425.95 kit
XSF-69Z	1969 Z/28 2.25".....	379.95 kit
XSF-69BB	1969 BB 2.5".....	399.95 kit

Ships Oversize 2.



XCE-200K

Chambered Exhaust Systems

OE style reproduction of this radical factory installed high performance exhaust system. This is a high quality aluminized system and features all of the correct features with correct tailpipe exits.

	Aluminized	SS
XCE-80K	1967-68 SB.....559.95 kit.....	899.95 kit
XCE-90K	1967-68 BB.....529.95 kit.....	899.95 kit
XCE-100K	1969 SB.....529.95 kit.....	899.95 kit
XCE-200K	1969 BB.....559.95 kit.....	899.95 kit

Ships Oversize 2.



XHP-678K

Exhaust Hanger Kits

Complete with all necessary hardware to install your new OEM style dual exhaust system.

XHP-678K	1967-68 Dual.....	112.95 kit
XHP-69K	1969 Dual.....	112.95 kit
XCI-69K	1967-69 Chambered.....	119.95 kit



PVD13

Downturns

These universal downturns are perfect for off road applications when tail pipes are not desired.

PVD10	2.5" 409 Stainless.....	59.99 pr.
PVD13	3" Aluminized.....	72.99 pr.



DGU14S



Downpipes

If you are using stock manifolds, you will need a pair of these downpipes to connect to the system. 409 Stainless steel.

DGU14S	1967-81 SB.....	152.99 pr.
DGU20S	1967-81 BB.....	140.99 pr.

PVR19S



Collector Reducers

These act as connectors from your header collectors to intermediate pipes for a clean look.

PVR10S	3" Header to 3" Pipe.....	84.99 pr.
PVR13S	3.5" Header to 3" Pipe.....	84.99 pr.
PVR16S	3" Header to 2.5" Pipe.....	84.99 pr.
PVR19S	3.5" Header to 2.5" Pipe.....	84.99 pr.



EVT59

EVT49

Pypes Exhaust Tips

Add the finishing touch to your exhaust system with a set of triple chrome plated tips from Pypes! All tips are slip fit.

EVT49	2.5" Angle Cut.....	38.99 pr.
EVT50	3" Angle Cut.....	48.99 pr.
EVT59	2.5" Hockey Stick Style.....	100.99 pr.
EVT61	3" Hockey Stick Style.....	100.99 pr.



HDR100S



Pypes Big Block Headers

Pypes big block headers feature large 2" primary tubes and 3.5" collectors with power spikes. Constructed of 304 mandrel bent stainless steel and fully TIG welded they include stainless collector reducers, premium hardware and gaskets.

HDR100S	1968-69 BB.....	643.99 ea.
---------	-----------------	------------

No volume discount.

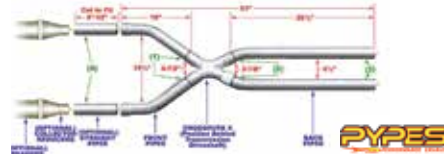

Pypes Universal X-Pipes

XVA10

If you are really looking to give your muscle car an easy 15-30 horsepower boost, toss your old balance tube and go with one of these new X-Crossovers from Pypes. This new siamese design is dyno proven to increase horsepower and torque.

	409	Polished
XVX10	1967-81 2.5".....	299.99 ea.....N/A
XVX13	1967-81 3".....	299.99 ea.....N/A
XVA14	1967-81 3.5".....	319.99 ea.....N/A

Driveshaft Tunnel X-Pipes

XVF10	1967-81 2.5".....	199.99 kit.....279.99 kit
XVF13	1967-81 3".....	239.99 kit.....N/A

Ships Oversize 2.



XVX10F

Pypes Driveshaft Tunnel X-Pipe Legs w/ Dumps

This is a pair of Pypes dump pipes for the XVF10 X-pipe kit. These pipes replace the front legs of the XVF10 and dump straight back.

XVX10F	1967-81 2.5" 409.....	129.99 kit
XVX13F	1967-81 3" 409.....	137.99 kit



SGF70



Pypes Crossflow Exhaust System

This crossflow system was designed for incredible clearance but with an ultra high flow crossflow muffler. Includes the ONLY horsepower generating X-pipe kit designed to specifically run in the drive shaft tunnel for extra ground clearance.

SGF70	1970-81 2.5" 409 Stainless.....	599.99 kit
SGF70S	1970-81 2.5" 304 Polished Stainless.....	799.99 kit

Ships Oversize 2.



HVE10

Electronic Exhaust Cut Out Kit

This kit comes with 2-electric exhaust cutouts, wiring harness to control both cutouts w/ one switch, stainless steel mounting hardware and extra thick gaskets. This is the most weather resistant and water tight cut out kit on the market!

HVE10	3" All.....	375.99 ea.
-------	-------------	------------

Connects to any standard 3 inch collector including the following Pypes products: XVX10F and XVX13F.



Pypes Performance Exhaust Systems

Fabricated using the highest quality materials, the smooth, 16 gauge, mandrel-bent stainless steel pipe ensures maximum exhaust gas flow, which can significantly boost horsepower. The mufflers are precision matched to deliver the ultimate in sound and performance. Pypes systems come complete with a pair of precision matched Pypes mufflers, correct tailpipes, clamps and hangers. These systems can be installed at home without any special tools.

	409 SS	
SGF60R	1967-69 w/ X-Pipe 2.5" w/ Race Pros.....	549.99 kit
SGF60S	1967-69 w/ X-Pipe 2.5" w/ Street Pros.....	549.99 kit
SGF63R	1967-69 w/ X-Pipe 3" w/ Race Pros.....	599.99 kit
SGF63S	1967-69 w/ X-Pipe 3" w/ Street Pros.....	599.99 kit
SGF11R	1970-81 w/ X-Pipe 2.5" w/ Race Pros.....	499.99 kit
SGF11S	1970-81 w/ X-Pipe 2.5" w/ Street Pros.....	499.99 kit
SGF13R	1970-81 w/ X-Pipe 3" w/ Race Pros.....	575.99 kit
SGF13S	1970-81 w/ X-Pipe 3" w/ Street Pros.....	575.99 kit
SGF31R	1970-81 w/o X-Pipe 2.5" w/ Race Pros.....	499.99 kit
SGF31S	1970-81 w/o X-Pipe 2.5" w/ Street Pros.....	499.99 kit

Ships Oversize 2.



FLOW-17129

Flowmaster American Thunder Dual Exhaust Systems

With easy fit in mind, these systems are mandrel bent for maximum performance and include specially selected mufflers. American Thunder systems deliver a moderate to aggressive interior and exterior tone and are suited to the enthusiast who wants their performance to be heard.

- Mandrel bent 16 gauge aluminized tubing
- Includes hangers and hardware for easy installation
- Made in the USA

Below includes Super 40 Series Mufflers; Aggressive & Powerful Exterior Exhaust Tone

FLOW-17201	1967-69, 3", Aluminized, Dual Rear Exit.....	799.99 kit
------------	--	------------

Below includes Super 44 Series Mufflers; Moderate to Aggressive Exterior Exhaust Tone

FLOW-17129	1967-68, 2.5", Aluminized, Dual Side Exit.....	481.99 kit
FLOW-817129	1967-68, 2.5", Stainless, Dual Side Exit.....	611.99 kit
FLOW-17139	1969, 2.5", Aluminized, Dual Rear Exit.....	549.99 kit
FLOW-817139	1969, 2.5", Stainless, Dual Rear Exit.....	689.99 kit
FLOW-1050	1967-69 3" Aluminized Dual Rear Exit.....	330.99 kit

Crossmember back with weld in H pipe.



FLOW-17104

Below includes 80 Series Crossflow (Transverse) Muffler; Moderate Exterior Exhaust Tone

FLOW-17104	1967-74, 2.5", Aluminized, Transverse.....	580.99 kit
FLOW-817104	1967-74, 2.5", Stainless, Transverse.....	707.99 kit

Below includes 50 Series Delta Flow Mufflers; Moderate to Aggressive Exterior Exhaust Tone

FLOW-17149	1970-74, 2.5", Aluminized, Dual Rear Exit.....	599.99 kit
------------	--	------------

Below includes 50 Series Slim Line Mufflers; Moderate to Aggressive Exterior Exhaust Tone

FLOW-817571*	1975-81, 2.5", Stainless, Dual Rear Exit.....	778.97 kit
--------------	---	------------

*Off Road racing use only - not legal for use on catalyst equipped vehicles. Requires double hump crossmember. Requires fabrication and/or welding to adapt system to manifolds or headers. Note: These systems do not fit convertibles without a body X-brace modification.



FLOW-17233

Flowmaster American Thunder Cat Back Systems

American Thunder systems deliver a moderate to aggressive interior and exterior tone and are suited to the enthusiast who wants their performance to be heard. Like all Flowmaster systems, the benefits include improved throttle response, power and mileage. Designed for an easy fit, these systems include all necessary parts and hardware for easy installation.

- Dyno tuned for maximum performance
- Includes hangers and hardware for easy installation
- Moderate to aggressive sound exterior exhaust tone
- Mandrel bent 16 gauge tubing

For the person who wants the look of a traditional dual exhaust system with all the benefits that a Flowmaster Cat-back exhaust system provides. D.O.R. (Dual out rear) systems are the perfect choice.

FLOW-17233	1986-91 5.0/5.7L 3" w/ 3" Flanged Cat*.....	499.99 kit
FLOW-17234	1986-91 5.0/5.7L 3" w/ 2.5" Flanged Cat**.....	457.99 kit
FLOW-17143	1993-95 5.7L LT1 2.5" w/ 3" Flanged Cat**.....	399.99 kit
FLOW-17133	1995-97 5.7L LT1 2.5" w/ Dual Cat**.....	399.99 kit
FLOW-17199	1998-02 5.7L LS1 3" w/ Dual Cat**.....	499.99 kit
FLOW-17358	1998-02 3.6L V6 2.5" w/ Slip Fit Cat*.....	999.99 kit
FLOW-817481	2010-13 6.2L SS 3" ***.....	999.99 kit
FLOW-817609	2010-13 6.2L SS ZL1 3" ****.....	1066.99 kit

*Moderate sound. **Aggressive sound. *** Will not fit with ground effects package. Does not fit models with dual mode exhaust option. Does not fit convertible models. **** Fits 2013-2015 Chevrolet Camaro SS and ZL1 with a 6.2L V8 engine and Dual Mode Exhaust Option. Also fits 2015 3.6L V6 with D/M Option. Fits Hardtop Coupe Models Only. No volume discount.



FLOW-817506

Flowmaster Force 2 Axle Back Systems

These quieter sounding systems are designed to replace original rear mounted mufflers located behind the rear axle using factory style connections. With easy fit in mind, these systems are mandrel bent for maximum performance, include specially selected mufflers and all necessary parts and hardware for easy installation. This Force II systems deliver a mild exterior and interior tone, and are suited to customers looking for efficiency improvements without a lot of noise. Like all Flowmaster systems, the benefits include improved throttle response, power and mileage.

- Dyno tuned for maximum performance
- Includes hangers and hardware for easy installation
- Stock to mild exterior exhaust tone
- Mandrel bent 16 gauge tubing

For the person who wants the look of a traditional dual exhaust system with all the benefits that a Flowmaster axle-back exhaust system provides. D.O.R. (Dual out rear) systems are the perfect choice

FLOW-817506	2010-13 6.2L SS 3**.....	659.99 kit
-------------	--------------------------	------------

* Will not fit with ground effects package. No volume discount.



FLOW-817744

Flowmaster American Thunder Axle Back Systems

This aggressive sounding system is designed to replace the original rear mounted mufflers located behind the rear axle. With easy fit in mind, the system is mandrel bent for maximum performance and includes specially selected mufflers to support the performance image of the car.

- Dyno tuned for maximum performance
- Includes hangers and hardware for easy installation
- Moderate to aggressive sound exterior exhaust tone
- Mandrel bent 16 gauge tubing

For the person who wants the look of a traditional dual exhaust system with all the benefits that a Flowmaster axle-back exhaust system provides. D.O.R. (Dual out rear) systems are the perfect choice

FLOW-817483	2010-15 3.6L V6 Hardtop 2.5" ...	669.99 kit
FLOW-817495	2012-13 6.2L SS Hardtop 3**.....	645.99 kit
FLOW-817743	2016-18 3.6L V6 2.5***.....	599.99 kit
FLOW-817744	2016-18 6.2L SS 3***.....	583.99 kit
FLOW-817746	2016-18 6.2L SS 3****.....	1158.99 kit
FLOW-817746	2016-19 6.2L ZL1 3****.....	1158.99 kit

* Will not fit with ground effects package. Does not fit models with dual mode exhaust option. Does not fit convertible models. **Does NOT Fit Vehicles Fitted With Performance Exhaust Option (Quad Tip). ***Fits WITH Performance Exhaust Option (NPP-Quad Tip). Does not fit with factory ground effects. No volume discount.



FLOW-817504

Flowmaster Outlaw Axle Back Systems

Our race-oriented Outlaw systems are designed to replace original rear mounted mufflers located behind the rear axle using factory style connections. With easy fit in mind, these systems are mandrel bent for maximum performance and include specially selected mufflers. Outlaw systems deliver an ultra aggressive interior and exterior tone and are suited to the enthusiast who wants the most aggressive components they can purchase. Like all Flowmaster systems, the benefits include improved throttle response, power and mileage.

- Dyno tuned for maximum performance
- Includes hangers and hardware for easy installation
- Aggressive loud exterior exhaust tone
- Mandrel bent 16 gauge tubing

For the person who wants the look of a traditional dual exhaust system with all the benefits that a Flowmaster axle-back exhaust system provides. D.O.R. (Dual out rear) systems are the perfect choice

FLOW-817504	2010-13 6.2L SS 3**.....	599.99 kit
FLOW-817686	2014-15 6.2L SS 3***.....	625.99 kit
FLOW-817745	2016-18 6.2L SS 3****.....	599.99 kit

*Fits hard top and convertible models, does not fit vehicles equipped with factory ground effects package. Does not fit models with dual mode exhaust option **Fits hard top and convertible models. Does not fit models with dual mode exhaust option *** Does NOT Fit Vehicles Fitted With Performance Exhaust Option (Quad Tip). No volume discount.



FLOW-81083



Flowmaster Scavenger Series X-Pipe

Flowmaster's new Scavenger X-pipe kit for the 2016-2019 Camaro SS and 2017-2019 Camaro ZL1 is a great way to improve the performance of your engine while giving your car a unique race inspired tone letting others know your serious when it comes to performance. Features dual 3.00 inch mandrel-bent 409s stainless steel tubing and utilizes Flowmaster's patented D-port design to help maximize exhaust scavenging. These Scavenger Series X-pipe assemblies are intended to be used as an upgrade to Flowmaster's rear section Axle-back kits, and replace the heavily flattened section of the factory system. Does not fit convertibles.

- Flowmaster reliability • Race proven technology
- Dyno tuned for maximum performance
- Stainless steel construction

FLOW-81083	2016-19 6.2L SS 3" Manual.....	327.99 kit
FLOW-81083	2017-19 6.2L ZL1 3" Manual.....	327.99 kit
FLOW-81084	2016-18 6.2L SS 3" Automatic.....	764.99 kit

No volume discount.



FLOW-15801



Flowmaster Pre-bent Tail Pipes

These 16 gauge mandrel bent pipe kits are designed to fit perfectly onto your vehicle with all the quality and performance that you would expect from Flowmaster.

- Premium Flowmaster quality
- Mandrel bent 16 gauge tubing • Rear exit

Aluminized Steel

FLOW-15801	1967-81 2.5"	155.99 pr.
FLOW-15822	1967-69 3".....	150.99 pr.

409 Stainless Steel

FLOW-815801	1967-81 2.5"	200.99 pr.
-------------	--------------------	------------

No volume discount.



FLOW-2010001



Flowmaster Direct Fit Catalytic Converters

Flowmaster Federal direct fit catalytic converters are stainless steel and meet USEPA standards and include a 25,000 mile emissions, and 50,000 mile/5 year exterior casing warranty.

- Flowmaster quality
- Meets or exceeds all USEPA 49-state requirement

FLOW-2010001	1982-94 V6/V8 2.5"	116.99 ea.
FLOW-2010008	1998-02 5.7L V8 2.25" LH.....	199.99 ea.
FLOW-2010009	2000-02 5.7L V8 2.25" RH.....	237.99 ea.

Not for use in California. No volume discount.



HKR-11051HKR



Hooker Dual Exhaust Cut-Out Kits

The choice is yours - Tease the Street or Please the Track with Hooker's new "Street-Tease" exhaust cut-outs! Good and "old" ideas improved with new materials, that's what we have here! These cut-outs will provide years of worry free use with a mixture of stainless steel and aluminum. The materials will keep the elements out, and the sound. Well that's up to you, with a flip of the toggle or a push of the remote button.

- Tig-welded T-304 stainless steel tubing for a clean and weather resistant finish
- 6061 aircraft aluminum motor and valve bracket
- Instant performance gains when opened
- Stainless tip can be positioned for any direction of exhaust
- Simple 12v cigarette lighter plug in for main power supply
- Welding Required

HKR-11051HKR	Dual 2.5"	425.99 kit
HKR-11052HKR	Dual 3"	425.99 kit

No volume discount.



FT-51606FLT



Flowtech Axle Back Exhaust Systems

Flowtech Exhaust Products are the perfect combination of quality and value.

- Quality welds for strength, longevity, and good looks
- Tube Geometry designed for maximum ground clearance and hassle free installation
- Lightweight 18-gauge, Stainless Steel material maximizing strength and durability
- Factory mounting points for ease of installation

FT-51600FLT	2010-15* SS 6.2L V8 2.5" 304 Stainless.....	397.99 kit
FT-51601FLT	2010-15** SS 6.2L V8 2.5" 304 Stainless	819.99 kit
FT-51604FLT	2010-15 SS 6.2L V8 3" 409 Stainless.....	353.99 kit
FT-51606FLT	2016-19*** SS 6.2L V8 2.75" 304 Stainless.....	393.99 kit
FT-51605FLT	2016-18*** 2L/3.6L 2.25" Stainless.....	393.99 kit
FT-51605RFLT	2016-18*** 2L/3.6L 2.25" w/o Mufflers Stainless.....	319.99 kit

*Fits coupe only. **Full cat back system.
***Without dual mode exhaust.



FT-16102-1FLT



Flowtech Mid-Length Headers

Flowtech headers are the perfect combination of performance and value. Flowtech Mid-Length headers are precision engineered using mandrel bent tubing, formed collectors and 5/16" flanges with sealing rings for a leak-free seal.

- Tuned-length primary tubes for street performance
- Mandrel-bent tubing for smooth exhaust flow
- Light weight & sturdy 16 gauge tubing
- Mandrel-formed Power Plenum collector for low back pressure
- Sturdy, leak-tested O-Ring port seals
- Engineered for an easy, trouble-free precision fit
- Includes all mounting hardware and premium gaskets

Small Block

FT-11108FLT	1967-81 Black Paint 1-1/2" Tubes 2.5" Collector.....	165.99 pr.
FT-11102FLT	1982-92* Black Paint-1 1/2" Tubes 2.5" Collector.....	170.99 pr.
FT-11102YFLT	1982-92 Y-pipe For FT-11102FLT 2.5" To 3	168.99 ea.

Kits below include Y-pipe

FT-16102FLT	1986-92* Black Paint 1-1/2" Tubes 2.5" Collector.....	378.99 pr.
FT-16102-1FLT	1986-92* Silver Ceramic 1-1/2" Tubes 2.5" Collector.....	592.99 pr.

*Features O2 oxygen sensor bung. No volume discount.



FT-49100FLT



Flowtech Afterburner Headers

Flowtech's Afterburner Turbo Chamber Headers represent the first new major design change in exhaust technology in decades. This design combines the race-proven 4 into 1 design with the torque managing capabilities of a Tri-Y header. The turbo chamber helps smooth out exhaust turbulence for increased performance and a broad power curve.

- Horsepower and Torque increased over conventional header design
- Big 3" secondary collector for reduced back pressure
- Tuned-length primary tubes combine with Velocity Tube to smooth out exhaust pulses
- All hardware and premium gaskets included for a complete installation
- Patented Velocity Tube increases cylinder scavenging

FT-49100FLT	1967-81 Black Paint 1 5/8" 3" Collector.....	261.99 pr.
FT-49100-1FLT	1967-81 Silver Ceramic 1 5/8" 3" Collector.....	453.99 pr.

No volume discount.



FLOW-814112



Flowmaster Scavenger Series Elite Headers

- Stainless steel construction • Ball & socket collector connections
- Dyno tuned for maximum performance
- High temperature ceramic coated • 0.375 thick laser cut flanges

FLOW-814110 1967-81, 265-400 SB,
1-5/8" Primary.....717.99 kit

3" collector outlet diameter; reducers included. Fits D port cylinder heads.

FLOW-814111 1967-81, 396-502 BB,
1-3/4" Primary.....717.99 kit

3" collector outlet diameter; reducers included. Will not fit Saginaw close ratio with 825 power steering box. Big block frame stands and motor mounts must be used to ensure proper engine location and header fit.

FLOW-814112 1967-69, 396-502 BB,
2" Primary.....717.99 kit

3.5" collector outlet diameter; reducers included. Big block frame stands and motor mounts must be used to ensure proper engine location and header fit.

FLOW-814115 1967-69, LS1, LS6,
1-3/4" Primary.....649.99 kit

3.5" collector outlet diameter; reducers included



FLOW-814121



Flowmaster Scavenger Series Elite Shorty Headers

Flowmaster's Scavenger Series Elite shorty headers are designed to replace the restrictive factory manifolds. These high quality headers are manufactured from stainless steel and are ceramic coated for maximum durability. They feature 1-3/4 in. primary tubes, 3/8 in. thick laser cut flanges and factory collector connections, ensuring a direct-fit, leak free installation. Like all Flowmaster products, the benefits include improved throttle response, power and engine efficiency.

- 3/8" laser cut flanges
- Dyno tuned for maximum performance
- High temperature ceramic coating
- 409 stainless steel construction

FLOW-814121 2010-14 SS 6.2L
1-3/4" Primary.....717.99 pr.

No volume discount.



HKR-8501-1HKR



Hooker Cast Iron Exhaust Manifolds

Hooker cast iron exhaust manifolds have been designed to hug close to the engine block so they fit into a wide variety of replacement and engine-swap applications. Their shorty design means you can route exhaust tubing close to your frame/ floor pan for maximum ground clearance. "Hook" up your GM LS engine with Hooker cast iron manifolds today!

- Intended for all GM LS (except LS7 and LS9) engine swap applications where durability, quiet operation, emissions compliance and leak-free sealing is desired
- Cast from Hi-Silicon-Moly Ductile Iron to provide durability and corrosion resistance
- 2.25-inch outlet diameter
- Free-flowing for good performance and catalytic converter efficiency
- Recommended for strong performance on engines making up to 500 horsepower

HKR-8501-1HKR Silver Ceramic Coated.....431.99 kit
 HKR-8501-3HKR Black Ceramic Coated.....431.99 kit
 HKR-8501-4HKR Titanium Ceramic Coated.....431.99 kit
 HKR-8501HKR Natural Cast Finish.....323.99 kit
 HKR-8510HKR Natural Cast Finish Turbo*.....477.99 kit

*For use with a turbo charger. No volume discount.



FT-11100FLT

Flowtech Long Tube Headers

Flowtech headers are the perfect combination of performance and value. Flowtech long tube headers are precision engineered using mandrel bent tubing, formed collectors and 5/16" flanges with sealing rings for a leak-free seal. All mounting hardware and gaskets are included for a simple installation. This header is coated in a high heat resistant black paint for a stealthy appearance. Instant performance gains when opened

- Tuned-length primary tubes for street performance
- Mandrel-bent tubing for smooth exhaust flow
- Light weight & sturdy 16 gauge tubing
- Mandrel-formed Power Plenum collector for low back pressure
- Sturdy, leak-tested O-Ring port seals
- Engineered for an easy, trouble-free precision fit
- Includes all mounting hardware and premium gaskets

Small Block

FT-11100FLT 1967-81 Black Paint 1-5/8" Tubes
3" Collector.....167.99 pr.

FT-31100FLT 1967-81 Silver Ceramic 1-5/8" Tubes
3" Collector.....355.99 pr.

Big Block

FT-11130FLT 1967-81 Black Paint 1-3/4" Tubes
3" Collector.....191.99 pr.

FT-11132FLT 1967-81 Black Paint 1-7/8" Tubes
3.5" Collector.....223.99 pr.

No volume discount.



FT-11701FLT

Flowtech Block Hugger Headers

Flowtech Block Hugger headers are ideal for street rods where fit and finish is really important. Block Huggers make performance and style easy for engine swaps and with our new Hugger Toobs you Can hook up to an existing system with ease.

- Computer-controlled mandrel-bent tubing for smooth exhaust flow
- Sturdy 16 gauge tubing
- Easy installation - can be used with stock motor mounts
- Precision die-cut exhaust port flanges
- Engineered and tested for a leak-proof seal
- All necessary hardware included for a complete installation

Small Block

FT-11000FLT 1967-92 Black Paint 1-5/8" Tubes
2.5" Collector.....187.99 pr.

FT-31000FLT 1967-92 Silver Ceramic 1-5/8" Tubes
2.5" Collector.....365.99 pr.

Big Block

FT-31030FLT 1967-92 Silver Ceramic 1-3/4" Tubes
2.5" Collector.....492.99 pr.

Big Block Tight Fit

FT-11701FLT 1967-92 Black Paint 1-3/4" Tubes
2.5" Collector.....228.99 pr.

FT-11701-1FLT 1967-92 Silver Ceramic 1-3/4" Tubes
2.5" Collector.....340.99 pr.

FT-11701-7FLT 1967-92 Stainless 1-3/4" Tubes
2.5" Collector.....340.99 pr.

FT-11701-2FLT 1967-92 Chrome 1-3/4" Tubes
2.5" Collector.....340.99 pr.

No volume discount.

Flowtech Shorty Headers

Flowtech headers are the perfect combination of performance and value. Flowtech headers are precision engineered using mandrel bent tubing, formed collectors and 5/16" flanges with sealing rings for a leak-free seal.

- Short tube header design for maximum ground clearance
- Mandrel-Formed Power Plenum for maximum flow
- Constructed of .049 cold roll flash mild steel tubing
- Sturdy, leak-tested O-Ring port seals
- Engineered for an easy, trouble-free precision fit
- Includes all mounting hardware and premium gaskets

Small Block

FT-11114FLT 1982-89 Black Paint 1-1/2" Tubes
2.5" Collector.....168.99 pr.

FT-11116FLT 1982-92 Black Paint 1-1/2" Tubes
2.5" Collector.....168.99 pr.

FT-31138FLT 2010-14 Silver Ceramic 1-3/4" Tubes
2.5" Collector.....569.99 pr.

No volume discount.



COLD-18A



COLD-545AFK



COLD-547AFK

1967-81 Cold Case Radiators

These COLD-CASE radiators are TIG welded 100% aluminum. These radiators have dual oversize 1-1/4" cooling rows making them more efficient than four 1/2" rows seen on 4 row models. Cold Case aluminum radiators cool 20% better than OEM copper radiators and are more than 50% lighter. They are original in appearance with OEM style stamped tanks for strength and that OEM original look. Once painted, they look like originals to all but the concourse fanatic. Each radiator is pressure tested, direct fit and carries a Lifetime Warranty!

COLD-549M	1967-69 SB Manual	359.99 ea.
COLD-549A	1967-69 SB Auto	369.99 ea.
COLD-11M	1967-69 BB Manual	359.99 ea.
COLD-11A	1967-69 BB Auto	369.99 ea.
COLD-18M	1970-81 SB Manual	369.99 ea.
COLD-19A	1970-81 SB Auto	359.99 ea.

Kits With Electric Fans And Shroud

Cold Case made it easy with kits that include the radiator, fan and shroud. All kits come with transmission cooler fittings in the radiator.

COLD-11AFK	1967-69 BB All Single 16" Fan	549.99 kit
COLD-547AFK	1967-69 LS Swap All 16" Fan	549.99 kit
COLD-545AFK	1970-81 SB/BB All Dual 12" Fans	584.99 kit
COLD-557AFK	1970-81 LS Swap All 16" Fan	584.99 kit
COLD-RC100	Radiator Cap All	24.99 ea.
COLD-FAN12	12 Inch Cooling Fan 1400 CFM	59.95 ea.
COLD-FAN16	16 Inch Cooling Fan 2500 CFM	75.99 ea.
COLD-EF1	Fan Wiring Kit All	89.99 kit

All radiators are shipped Oversize. Not eligible for free shipping.

Frostbite Performance Cooling

High-Horsepower street cars and race cars can be a challenge to keep cool. A proper cooling system starts with Frostbite. When it comes to keeping your ride cool, Make it Frostbite!



Aluminum Radiators

Our line of Performance Aluminum Radiators are available in 2, 3 and 4-row sizes as well as specific LS-Swap applications.

- 100% TIG welded (brazed) seams
- Aircraft quality aluminum core, fittings and tanks (up to 30% weight savings)
- Billet Aluminum Filler Neck and OEM style Brass Petcock
- Custom Frostbite High Performance 16lb radiator cap
- Polished top and tanks for custom show appearance
- 2-Row Radiators supporting applications with 300-500 horsepower • Transmission cooler provisions

Direct Fit

FROST-FB144	67-69 V8 All 2 Row 20.75" Wide	251.99 ea.
FROST-FB145	67-69 V8 All 3 Row 20.75" Wide	314.99 ea.
FROST-FB146	67-69 V8 All 4 Row 20.75" Wide	418.99 ea.
FROST-FB147	67-69 V8 All 2 Row 23" Wide	251.99 ea.
FROST-FB148	67-69 V8 All 3 Row 23" Wide	314.99 ea.
FROST-FB149	67-69 V8 All 4 Row 23" Wide	418.99 ea.
FROST-FB162	70-81 V8 All 2 Row 26" Wide	251.99 ea.
FROST-FB163	70-81 V8 All 3 Row 26" Wide	314.99 ea.
FROST-FB164	70-81 V8 All 4 Row 26" Wide	418.99 ea.
FROST-FB188	82-92 All 2 Row 17.25" Tall	248.99 ea.
FROST-FB189	82-92 All 3 Row 17.25" Tall	311.99 ea.
FROST-FB190	82-92 All 4 Row 17.25" Tall	414.99 ea.
FROST-FB185	98-99 All 2 Row 17.75" Tall	248.99 ea.
FROST-FB186	98-99 All 3 Row 17.75" Tall	311.99 ea.

LS Swap

Hose fittings sold separately.		
FROST-FB300	67-69 LS All 2 Row 20.75" Wide	501.99 ea.
FROST-FB301	67-69 LS All 3 Row 23" Wide	501.99 ea.
FROST-FB302	70-81 LS All 3 Row 26.25" Wide	501.99 ea.
FROST-FB303	82-92 LS All 3 Row 26.25" Wide	501.99 ea.

Electric Fan & Shroud Kits

Fans & Shroud Kits E= Economy H= High Performance

FROST-FB513E	Dual 10" Fits FB 144, 145, 146 Radiators	311.99 kit
FROST-FB513H	Dual 10" Fits FB 147, 148, 149 Radiators	393.99 kit
FROST-FB523E	Dual 12" Fits FB 188, 189, 190 Radiators	311.99 kit
FROST-FB523H	Dual 12" Fits FB188, 189, 190 Radiators	403.99 kit

Shroud Only Dual Opening

FROST-FB513	Dual 10" Fits FB 147, 148, 149, 301 Radiators	174.99 ea.
FROST-FB502	Dual 10" Fits FB 162, 163, 164, 302 Radiators	174.99 ea.
FROST-FB523	Dual 12" Fits FB 188, 189, 190, 303 Radiators	174.99 ea.

Note: Width and height measurements are for the core not overall. No volume discount.

Fan Relay & Wiring Kit

This relay kit will allow you to custom configure your fans as pusher or puller resulting in increased cooling performance and a reduction in noise/vibration in your engine bay. Does 1 or 2 fans.

FROST-FB403	All With Electric Fans	93.99 kit
-------------	------------------------	-----------

No volume discount.

Hose Fittings

FROST-FB400	LS Swap 1.25"	50.99 ea.
FROST-FB401	LS Swap 1.5"	50.99 ea.
FROST-FB402	LS Swap 1.75"	50.99 ea.

No volume discount.



FROST-FB188



FROST-FB513E



FROST-FB523H



FROST-FB-400



FROST-FB-401



FROST-FB-402



CCS-CCFK10



CCS-CCFKRL



Aluminum Radiators by Champion Cooling Systems

These aluminum radiators are made to the highest of standards paired with unequalled quality precision and workmanship. All Champion aluminum radiators are constructed using 100% welded seams brazed core technology and absolutely no epoxy. All Champion radiators come with a lifetime limited warranty and are made to install with little or no modifications using your original mounts, giving you the confidence you deserve. Choose from the following series:

Economy Core Series - 2 Rows of 3/4" Tubes = Approx. 400-600+ HP Cooling Capacity.

Champion Core Series - 3 Rows of 5/8" Tubes = Approx. 600-800+ HP Cooling Capacity.

Monster Core Series - 4 Rows of 5/8" Tubes = Approx. 800-1200+ HP Cooling Capacity.

SB = Small Block, BB = Big Block

CCS-EC337	1967-69 Economy Core Series SB 19 1/4" x 28 3/4".....	196.95 ea.
CCS-EC370	1967-69 Economy Core Series BB 19 1/4" x 30 1/4".....	196.95 ea.
CCS-CC337	1967-69 Champion Core Series SB 19 1/4" x 28 3/4".....	259.95 ea.
CCS-CC370	1967-69 Champion Core Series BB 19 1/4" x 30 1/4".....	249.95 ea.
CCS-MC337	1967-69 Monster Core Series SB 19 1/4" x 28 3/4".....	344.95 ea.
CCS-CC337B-M	1967-69 Champion 3 Core Series SB 19 1/4" x 28 3/4".....	259.95 ea.
CCS-MC370	1967-69 Monster Core Series BB 19 1/4" x 30 1/4".....	344.95 ea.
CCS-EC162	1970-81 Economy Core Series 18 1/4" x 31 5/8".....	196.95 ea.
CCS-CC162	1970-81 Champion Core Series SB 18 1/4" x 31 5/8".....	259.95 ea.
CCS-MC162	1970-81 Monster Core Series 18 1/4" x 31 5/8".....	344.95 ea.
CCS-EC951	1982-92 Economy Core Series 20 x 32".....	196.95 ea.
CCS-CC951	1982-92 Champion Core Series 20 x 32".....	259.95 ea.
CCS-CC951-M	1982-92 Champion 3 Core Series SB 20" x 30".....	259.95 ea.
CCS-MC951	1982-92 Monster Core Series 20 x 32".....	344.95 ea.

Electric Cooling Fans

Features a reversible swept blade design meaning it can be configured as a puller or pusher. The blades are computer balanced.

CCS-CCFK10	10", 7.5 Amp Draw, 650 CFM.....	39.95 ea.
CCS-CCFK12	12", 10 Amp Draw, 870 CFM.....	39.95 ea.
CCS-CCFK14	14", 12 Amp Draw, 1200 CFM.....	44.95 ea.
CCS-CCFK16	16", 14 Amp Draw, 1600 CFM.....	59.95 ea.
CCS-CCFKRL	Fan Relay.....	59.95 ea.

Aluminum Fan Shrouds

Designed to fit Champion aluminum radiators and hold electric fans.

CCS-FS162	Fits 162 Radiators Holds (2) 14" Fans.....	132.95 ea.
CCS-FS337	Fits 337 Radiators Holds (2) 10" Fans.....	132.95 ea.
CCS-FS370	Fits 370 Radiators Holds (2) 10" Fans.....	132.95 ea.
CCS-FS951	Fits 951 Radiators Holds (2) 12" Fans.....	132.95 ea.

Factory Replacement Radiators

These direct factory replacement Super Cooler radiators come complete with new high density cores, correct screw in fittings for automatics, correct mounting brackets where applicable and are ready to install.

AXX-214A	1967-69 SB 3 Row 21" Automatic.....	389.95 ea.
AXX-214M	1967-69 SB 3 Row 21" Manual.....	419.95 ea.
AXX-334A	1967-69 BB 4 Row 23" Automatic.....	449.99 ea.
AXX-334M	1967-69 BB 4 Row 23" Manual.....	449.99 ea.
AXX-23CA	1967-69 BB 4 Row SHP Bent Neck Automatic.....	399.95 ea.
AXX-23CM	1967-69 BB 4 Row SHP Bent Neck Manual.....	399.95 ea.
AXX-263A	1970-73 All 4 Row 26" Automatic.....	422.95 ea.
AXX-263M	1970-73 All 4 Row 26" Manual.....	462.95 ea.
VHT-SP139	Radiator Paint.....	7.99 ea.

All radiators are shipped Oversize. No Volume Discount.



AXX-679A



AXX-679A-KIT



AXX-70R

1967-81 Aluminum Radiator

This Camaro aluminum radiator features an oversized two core design that will keep your high performance engine running cool. The shiny finish of the aluminum will look great on any show car!

AXX-679A	1967-69 23L x 19H x 2.75W.....	239.99 ea.
AXX-679A-KIT	1967-69 23L x 19H x 2.75W w/ Fan Shroud & Relay.....	321.47 kit
AXX-70R	1970-81 26".....	199.95 ea.

Note: May require modifications to fan shroud. Aftermarket electric fans recommended because of tight clearance issues with stock fan depending on engine application. All radiators are shipped Oversize. No Volume Discount.



Dakota Digital Fan Controller

PAC-2750

The PAC-2750 was designed for the ultimate in flexibility and to be a simple add-on in any application using an electric fan. Included is a 70amp relay, enough for even the most power hungry of cooling fans. Fully programmable, the PAC-2750 will work with your existing water temp gauge, operating from the temperature sending unit already installed.

PAC-2800BT	All.....	128.99 kit
------------	----------	------------

Not eligible for volume discounting.





ACR-001

Universal Coolant Recovery Tank

This compact tank can be mounted anywhere and is used to recover coolant overflow. 6" wide x 4" deep x 5" tall.

ACR-001 Universal..... 10.95 ea.



AOF-172

Stainless Overflow Tank

This polished stainless steel universal fluid reservoir is perfect for older muscle cars that did not come from the factory with a coolant recovery tank.

AOF-103 10" x 3" 54.99 ea.
 AOF-132 13" x 2" 54.99 pr.
 AOF-152 15" x 2" 54.99 ea.
 AOF-172 17" x 2" 54.99 ea.

Note: 1/4 in. Hose Barb Inlet/Outlet



AP-70-AC

Radiator Top Panels

Correct reproduction top panels that hold your radiator in place.

AP-70 1970-81 w/o AC 23 3/4" x 5-1/4" 3 Bolt. 24.95 ea.
 AP-70-AC 1970-81 w/ AC 28 1/2 x 5-5/8" 3 Bolt..... 24.95 ea.
 GCS-S9427 1968-73 Chrome 3 Bolt w/o AC
 23-3/4" x 5-1/4" 17.84 ea.
 GCS-S9425 1970-81 3 Bolt
 23-7/8" Long Chrome 16.79 ea.
 GCS-S9426 1970-81 3 Bolt HD Cooling
 28-11/16" Long Chrome..... 16.79 ea.



AB-31X

Radiator Attaching Hardware

Correct OEM hardware for attaching the radiator to the support.

AB-31X 1967-81 All 5.95 kit



AEF-14

Electric Cooling Fans

This electric cooling fan is perfect for cars where an electric water pump is being used or as supplemental cooling.

AEF-12 12" Universal 54.99 ea.
 AEF-14 14" Universal 54.99 ea.
 AEF-16 16" Universal 56.99 ea.



ABR-3996

Fan Blades

Reproduction fan blades to be used with fan clutches only.

APR-705 1967-68 5 Blade 17.5" 99.95 ea.
 ABR-6BLD 1967-68 6 Blade 17.5" 79.95 ea.
 ABR-7BLD 1967-68 7 Blade 17.5" Curved Tips 99.95 ea.
 ABR-3996 1969-72 7 Blade 17.5" 79.95 ea.



AWT-7719



ABR-2710



BKP-516

Fan Clutches

Heavy duty fan clutch with gold cadmium coloring, in limited supply!

AWT-7719 1967-68 Short Pump Replacement 52.95 ea.
 ABR-2710 1969-81 Long Pump 69.95 ea.
 BKP-516 Correct Attaching Nuts 4pc 1.50 kit



Fan Attaching Kits

BPX-2792

Correct style bolts/studs for attaching fan to water pump.

BPX-2792 Attaching Stud Kit 12pc 6.95 kit
 BPX-2791 Attaching Bolt Kit 8pc 5.95 kit

AJC-194



AOJ-153

Radiator Overflow Jars

Overflow jar is manufactured from high grade plastic and features the correct ADD/FULL lines for 1973-77 models and HOT/COLD lines for 1978-79 models as original.

AOJ-153 1973-77 Jar 29.99 ea.
 AOJ-563 1978-79 Jar 39.99 ea.
 AJC-194 1974-75 Cap 7.95 ea.
 AOJ-978 1978-81 Cap 9.99 ea.
 AOJ-175 1989-92 Jar 69.95 ea.



AAC-6072
Detail



AAC-6072

Radiator Caps

Your choice of exact reproduction GM RC15 cap with correct large ears and correct wording or new GM replacement.

AAC-6072 Reproduction 29.99 ea.
 AAC-6415 Replacement 18.95 ea.



ATE-4100

ATE-6041

Radiator Mounting Pads

Correct upper and lower rubber pads for mounting your radiator into the support. Lower pads feature steel cores.

ATE-6041 1970-81 HD 4 Core Upper 9.95 pr.
 ATE-4100 1970-81 HD 4 Core Lower 9.95 pr.
 ATE-6SB 1970-81 SB 3 Core All 9.99 ea.



FANKIT-6BS

BUY 'N SAVE
WITH KITS



Fan Clutch Kits

Complete kit to convert your car to this heavy duty GM fan clutch option. This kit includes fan, fan clutch and all necessary hardware.

FANKIT-6BS 1967-68 6 Blade SWP 111.88 kit
 FANKIT-5BR 1967-68 5 Blade SWP 127.88 kit
 FANKIT-7BS 1967-68 7 Blade Curved SWP 127.88 kit
 FANKIT-7BL 1969-73 7 Blade LWP 125.48 kit

OEM Fan Shrouds

These are OE style fan shrouds unless otherwise stated. These fan shrouds will mount correctly to all original OE radiators and are a must for final engine compartment detailing.

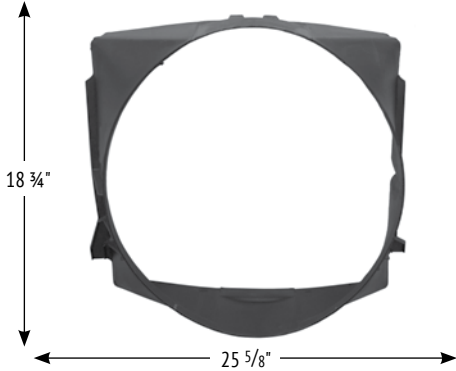

ABC-3812 1967-68 SB w/o A/C for 21" Radiator, GM..... 194.95 ea.

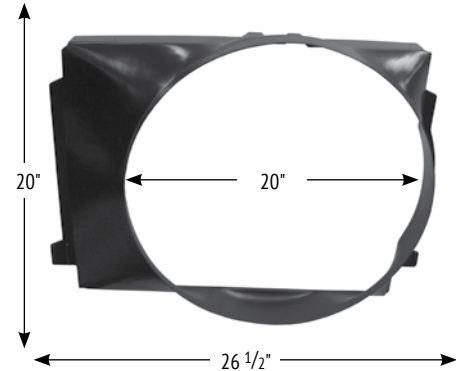

ACL-9956 1967-68 BB..... 94.95 ea.
Note: This is a high quality, concourse quality reproduction which meets or exceeds OEM.

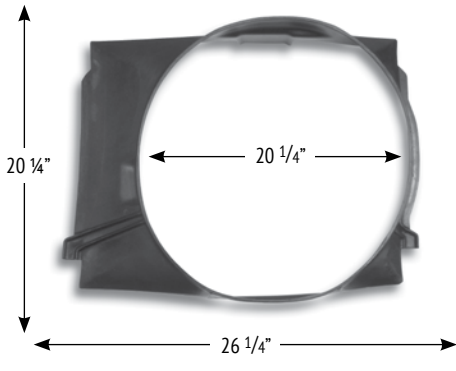

3947619 1969 BB..... 99.99 ea.
Note: This is a high quality, concourse quality reproduction which meets or exceeds OEM.



Fan Shroud Clip Kit

Correct lower shroud attaching clip set for all 1967-69 Camaros with factory Harrison radiators. (The large clip attaches to the lower right side of the tank.)

AHB-679K 1967-69 All20.61 kit

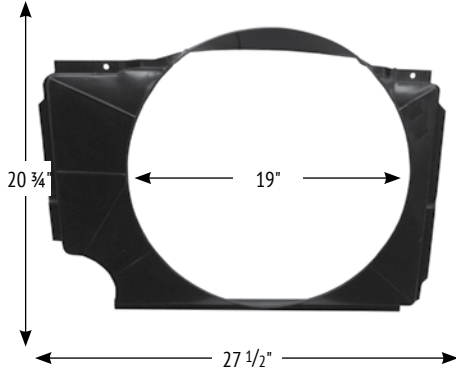

ADR-170 1970-81 All BB..... 79.95 ea.
Note: This is a high quality, concourse quality reproduction which meets or exceeds OEM.

BUY'N SAVE
WITH KITS

New Tooling

ABC-3910K 1970-81 Small Block HD Cooling 169.99 ea.



Fan Shroud Attaching Bracket

Correct bracket kits for mounting shroud.

AKW-1112 1967-69 SB.....13.99 kit
AKW-1112 1967-68 BB.....13.99 kit
AKW-0142 1969 BB.....8.95 kit

Reproduction Fan Shrouds

These reproduction fan shrouds are good for the daily driver or those restoring on a budget. These fan shrouds are of a lesser quality than our GM fan shrouds and may require some modification to fit properly, but they are a much more economical alternative.

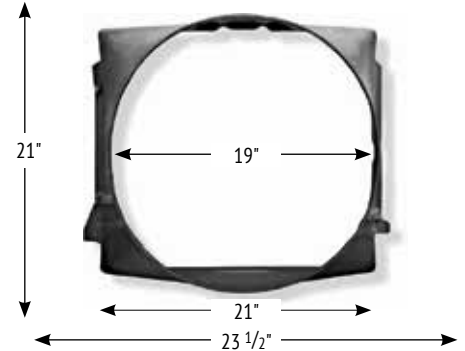

3893812 1967-68 SB w/o A/C..... 139.99 ea.

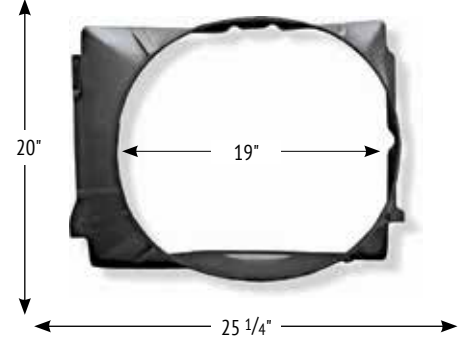

3893814 1967-69 SB w/ A/C..... 144.95 ea.

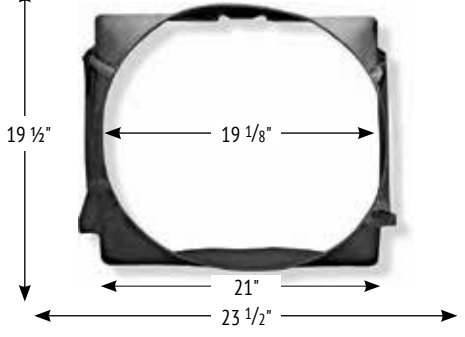

3938615 1969 SB w/o A/C..... 139.95 ea.

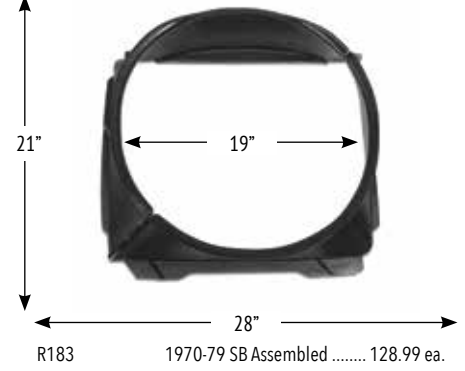

R183 1970-79 SB Assembled 128.99 ea.



Tower Clamp Kits

Original Witek Tower style clamps. These factory installed clamps were used on most GM cars. 1967-68 used tower clamps on the radiator hoses and spring clamps on the heater hoses. Cars built 1969 or later used all tower clamps.

CPX-6368	1967-68 8pc.....	22.95 kit
CPX-4796	1969-81 8pc.....	26.95 kit



Radiator Overflow Hose OEM

Correct thin walled ribbed hose as original.

CPN-0638	1967-81.....	2.95 per ft.
----------	--------------	--------------



Radiator Overflow Hose Clip

Correct clip for retaining overflow hose.

CPX-8739	All.....	12.95 ea.
----------	----------	-----------



Radiator Petcock

Correct gold colored fluted end drain valve for radiator.

AXP-1106	All.....	4.95 ea.
----------	----------	----------



Heater Hose Retainers

Correct heater hose retainers for inside of passenger fender and top of alternator bracket.

ATE-2059	RH Fender.....	6.99 ea.
ATE-5416	ALT Bracket.....	6.99 ea.

Upper Radiator Hoses

OE style reproduction upper radiator hoses featuring the correct GM part numbers and ID codes!



CPH-2626	1967 SB.....	16.95 ea.
CPH-2650	1967-68 Z/28.....	16.95 ea.
CPH-2684	1968 SB.....	16.95 ea.



CPH-1650	1969 SB, Z/28.....	16.95 ea.
CPH-3192	1970-81*.....	19.95 ea.
CPH-5531	1970-78 SB.....	19.95 ea.

*Use with aftermarket radiator.



CPN-9866	1967-69 BB.....	16.95 ea.
----------	-----------------	-----------



CPH-6039	1969 COPO.....	16.95 ea.
----------	----------------	-----------

For bent neck radiator

Lower Radiator Hoses

OE style reproduction lower radiator hoses featuring the correct GM part numbers and ID codes!



CPH-2628	1967-68 SB.....	16.95 ea.
----------	-----------------	-----------



CPH-2561	1969 SB.....	16.95 ea.
CPH-0122	1970-78 SB.....	16.95 ea.



CPH-9698	1967-68 BB.....	16.95 ea.
----------	-----------------	-----------



CPH-6044	1969 BB.....	16.95 ea.
CPH-3193	1970 BB.....	19.95 ea.
CPH-9486	1971-72 BB*.....	19.95 ea.

*Fits all 1971-81 big block.



Heater Hoses

New officially licensed GM restoration heater hose sets. 1967-68 hoses feature correct GM with box logo and 1969-81 features correct black ribbed design.

CPH-5834	1967-68.....	18.95 kit
CPR-5834	1969-81.....	21.95 kit



Heater Control Valve

New GM heater control valve for all Chevys with air conditioning. Correct gold plating

ACV-1901	1969-70 w/ A/C.....	46.95 ea.
AV-560	Screws 2pc.....	0.95 ea.

BUY'N SAVE
WITH KITS

SALE



AHC-KIT3

Heater Cores & Box Seal Kits

This kit includes an OEM heater core and neoprene seals. Components also available separately.

Kits	
AHC-KIT1	1967-68 SB w/o A/C..... 101.68 kit
AHC-KIT2	1969-81 SB w/o A/C.....92.68 kit
AHC-KIT3	1967-69 BB w/o A/C..... 119.68 kit
Cores	
AHC-9086	1967-68 SB w/o A/C.....89.99 ea.
AHC-9054	1967-68 All w/ A/C.....89.99 ea.
AHC-678BB	1967-68 BB w/o AC.....109.99 ea.
AHC-9065	1969-81 SB w/o A/C.....79.99 ea.
AHC-9056	1969 All w/ A/C.....89.99 ea.
AHC-8008	1969 BB w/o A/C.....109.99 ea.
AHC-781ACF	1970-81 All w/AC.....89.99 ea.
Seals	
JHC-3064	1967-81 All V8 w/o A/C.....22.99 kit



AHC-458

Heater Core Retaining Clips

Reproduction heater core clips manufactured from spring steel as original.

AHC-458	1967-69 BB..... 32.95 pr.
AHC-13641	1967-69 SB.....30.95 kit



AL-304

Heater Box Cover

Brand new firewall heater box cover for all cars without air conditioning.

AL-304	1967-81 SB w/o AC.....39.95 ea.
AL-303	1967-69 BB w/o AC.....69.95 ea.
AL-304-CHROME	1967-81 SB w/o AC Chrome.....79.95 ea.
AL-303-CHROME	1967-81 BB w/o AC Chrome.....85.95 ea.
AHC-CLAMP	1967-81 All That Use a Clamp.....19.99 pr.
ALS-27	Retaining Nut.....0.95 ea.
JCS-10459	Sealant.....9.95 ea.
AL-305	1967-69 BB non-A/C Tube Cover Plate..19.99 ea.
AL-963	Tube Cover Plate Seal Kit 2pc.....4.99 kit



AHC-691

Heater Boxes

New complete inner heater box assemblies for under the dash.

AHC-671	1967 Non AC.....299.95 ea.
AHC-691	1968-69 Non AC.....299.95 ea.

No Volume Discount



ABM-1041W

Heater Blower Motor

New OEM replacement heater blower motor for cars with or without A/C.

ABM-870	1967-77 Motor Only.....44.99 ea.
ABM-1041W	1967-77 w/ Cage.....70.18 ea.
ABM-CAGE	1967-81 Cage Only.....32.99 ea.
GWC-SPK	Wire Clips.....13.95 pr.



Heater Blower Motor Resistors

Correct blower motor resistors.

ABR-71	1967-68 w/ AC.....23.99 ea.
ABR-69AC	1969 w/ AC.....29.99 ea.
ABR-77	1967-72 w/o AC.....21.99 ea.
ABR-7381	1973-81 w/ AC.....69.99 ea.
ARS-304	Mounting Screws.....0.95 pr.

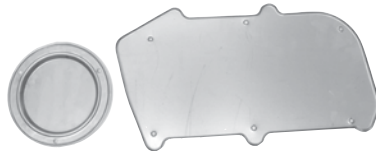

AHD-808

Heater Delete Plate

New factory style firewall heater delete plate set. This set comes with block off plates for firewall heater and blower motor assembly.

AHD-808	1967-69 w/o Orig A/C.....89.99 ea.
AHD-899	1967-69 w/ Orig A/C.....99.99 set
ABO-417	1967-69 BB Non A/C Hose Block Off.....19.95 ea.



AXB-7A

AC Delete Cover

This covers the large hole where your AC used to be and allows you to use your factory heater core when removing your AC.

AXB-7A	1967-69 All.....119.95 ea.
AXB-7B*	1970-81 All.....119.95 ea.
JCS-10459	Sealant.....9.95 ea.

*You must use a non-AC blower motor with this cover.

We recommend part ABM-CAGE.



AC Evaporator Seals & Drain

Correct grommets to seal the evap case from the engine compartment. Reproduction drain hose to engine compartment.

AHG-737	1967 Heater Hose Grommet.....27.99 ea.
APG-184	1967-69 Pipe Grommet.....14.99 ea.
APG-723	1970-81 Pipe Grommet.....23.99 ea.
AEC-73D	1967-81 Drain Grommet.....13.99 ea.



AXB-15241

AXB-67-AC DELETE

AC Delete Panels

These are bolt in panels to block off the AC openings on the firewall.

AXB-67-AC-DELETE	1967-69.....65.95 ea.
AXB-15241	1967-81 Steel.....49.95 pr.



DSE010901

Detroit Speed Firewall Fill Plate

An excellent way to smooth your firewall! Smooths the passenger side firewall while retaining the stock cowl to firewall seam. Weld-in panel made of 18 gauge steel with a rolled edge. Made in USA.

DSE010901	1967-69.....87.99 ea.
DSE010904	1970-81.....87.99 ea.

No Volume Discount



DSE010902

Detroit Speed Heater Delete Plate

This bolt-in plate is an easy way to smooth your firewall for that heater delete look. 18 gauge steel. Made in USA.

DSE010902	1967-69.....87.99 ea.
-----------	-----------------------



DSE010903

Detroit Speed A/C Delete Plate

This bolt-in plate is an easy way to smooth your firewall. 18 gauge steel. Made in USA.

DSE010903	1970-81.....87.99 ea.
-----------	-----------------------

AC Box Under Hood Hardware

All the hardware related to the AC under the hood on the firewall forwards.

67FA-F	1967.....43.99 kit
68FA-F	1968.....49.99 kit
69FA-F	1969.....59.99 kit
70FA-F	1970.....54.99 kit
71FA-F	1971.....47.99 kit
72FA-F	1972.....45.99 kit
73FA-F	1973.....49.99 kit

AC Box Under Dash Hardware

All the hardware related to the AC under the dash.

67FA-R	1967.....39.99 kit
68FA-R	1968.....40.99 kit
69FA-R	1969.....44.99 kit
70FA-R	1970.....36.99 kit
71FA-R	1971.....33.99 kit
72FA-R	1972-73.....38.99 kit

ATE-3907



Open Element Air Cleaner

Excellent reproduction of the original GM open element air cleaner assembly. Complete base with elbow assembly, chrome plated lid and AC Delco filter. Will fit most V8's with 4 bbl. carburetor.

ATE-3907	Complete Kit	84.99 kit
ACQ-1224	Chrome Lid Only	36.95 ea.
ACQ-1220N	Chrome Lid Only	
	w/ Service Instructions	59.95 ea.
AAC-8864	Base Only w/ Elbow Assembly.....	54.95 ea.

Everything You Need to Convert to Cowl Induction!

BUY 'N SAVE WITH KITS



Complete Cowl Induction Kit

This kit comes complete with every necessary item to install a functional cowl induction system on your 1967-69 Camaro with cowl induction hood. You get an air cleaner base, black lid, filter, steel flange, rubber seal, steel extension (where applicable), wiring harness, hood grommet, throttle arm, relay, electric solenoid, valve frame, flipper door, clips and hardware.

ACX-687	1967-69 Z/28	379.11 kit
ACX-688	1967-69 SB or 350	372.96 kit
ACX-689	1967-69 BB.....	360.74 kit

No Volume Discount



GCS-10095

Black Steel Air Cleaner Assembly

This black air cleaner assembly is constructed of steel and is a great inexpensive custom touch to any street machine or sleeper. Includes lid, filter, base and wing nut.

GCS-10095	Holley.....	29.95 kit
GCS-10099	Edelbrock.....	29.95 kit



ACQ-1260

Cowl Induction Air Cleaner

OE style reproduction of original GM including base, lid and filter.

ACQ-1260	Complete Kit w/ Black Lid	129.99 kit
ACQ-1260Z	Complete Kit w/ Chrome Lid	149.99 kit
ACQ-60	Black Lid Only.....	29.99 ea.
ACQ-1224	Chrome Lid Only	36.95 ea.

No Volume Discount. Will not work with HEI.

1967 Closed Air Cleaner System

New complete closed air cleaner assemblies for your 1967 Camaro complete with base, lid and filter!

ATW-3361	1967 SB Black Lid	145.95 kit
AM-3360	1967 396/325 or 350 HP*	149.95 kit
AM-3368	1967 Chrome Lid Only.....	74.99 ea.

*Can be used on SS350 models. *No Volume Discount.*



ATW-3361



ACC-569

1970-72 Dual Snorkel Air Cleaner

OE style reproduction complete with base and chrome lid. Originally equipped on non-cowl induction cars with L78 and L89 engine. Features correct snout with notch and PCV dimple.

ACC-569	1970	399.95 kit
---------	------------	------------

Note: Will not work with HEI.

ACX-79B without extension ring



ACX-79B

Cowl Induction Air Cleaner Kit

OE style reproduction of original GM including base, black lid, filter, flange, extension seal ring (where applicable) and rubber seal.

ACX-79	1967-69 Z/28 / 302	193.46 kit
ACX-79S	1967-69 350 / SB.....	188.28 kit
ACX-79B	1967-69 BB.....	162.77 kit

No Volume Discount



ACQ-1460

Dual Snorkel Air Cleaner Kit

OE style reproduction of the original 1970-74 Z/28 dual snorkel air cleaner assembly, complete with base, filter and lid.

ACQ-1460	1970-74 Complete Kit	184.99 ea.
ACQ-1461	1970-74 Chrome 17" Lid Only.....	59.95 ea.
ACQ-1462	1970-74 Black 17" Lid Only	29.95 ea.

No Volume Discount.



GCS-S6915C

GCS-S6813C

Ball Milled Air Cleaners

Highly polished ball milled flames aluminum 14" air cleaner. Includes washable 3" filter.

GCS-S6915	Flat Base w/ Flames.....	94.99 kit
GCS-S6905X	Drop Base w/ Flames.....	104.99 kit
GCS-S6815C	Drop Base.....	104.99 kit

Note: 5-1/8" carb opening.

Does not include stud, wing nut or gasket.



GCS-S6723

GCS-S6320

Finned Aluminum Air Cleaner

Highly polished finned aluminum 14" air cleaner. Includes washable 3" filter.

Round		
GCS-S6723	Flat Base.....	84.79 kit
GCS-S6725	Drop Base.....	84.79 kit

Oval

GCS-S6320	Flat Base.....	58.39 kit
-----------	----------------	-----------

Note: 5-1/8" carb opening. Includes mounting stud. Does not include wing nut or gasket.



GCS-S3196X

Stainless Steel Air Cleaner

Highly polished stainless steel 14" air cleaner. Includes washable 3" filter.

GCS-S8005X	Drop Base.....	50.39 kit
------------	----------------	-----------

Note: 5-1/8" carb opening. Includes mounting stud and chrome wing nut. Does not include gasket.

K&N Airfilter Kits

K&Ns custom air cleaner assemblies are designed with the racer in mind. They incorporate good looks as well as the superior air flow that you expect from K&N. These custom air cleaner assemblies are designed for use with any engine that uses a round element air cleaner housing. They incorporate K&N Air Filters and provide more air flow than other assemblies of this type. Each complete assembly comes with base, element and top plate. Provides more air flow to the engine, designed to increase horsepower, washable and reusable air filters.



Chrome Lid Drop Base

KN-60-1280	1967-81 14X3", 1-1/4" Drop Base.....	95.99 ea.
KN-60-1290	1967-81 14X4", 1-1/4" Drop Base...	130.99 ea.
KN-60-1300	1967-81 14X5", 1-1/4" Drop Base...	125.99 ea.
KN-60-1310	1967-81 14X6", 1-1/4" Drop Base...	123.99 ea.
KN-60-1430	1967-81 14X3", 7/8" Drop Base.....	116.99 ea.
KN-60-1440	1967-81 14X4", 7/8" Drop Base.....	118.99 ea.
KN-60-1450	1967-81 14X5", 7/8" Drop Base.....	127.99 ea.
KN-60-1460	1967-81 14X6", 7/8" Drop Base.....	129.99 ea.

Chrome Lid Raised Base

KN-60-1263	1967-81 14X2 5/16", 9/16" Raised Base.....	118.99 ea.
KN-60-1264	1967-81 14X3", 9/16" Raised Base.	104.99 ea.
KN-60-1260	1967-81 14X4", 9/16" Raised Base.	134.99 ea.
KN-60-1270	1967-81 14X4", 9/16" Raised Base.	145.99 ea.

X-Stream w/ Dropped Base

KN-66-3050	1967-81 14X3" 7/8" Drop Base.....	172.99 ea.
KN-66-3040	1967-81 14X3", 1-1/4" Drop Base...	131.99 ea.
KN-66-3060	1967-81 14X4", 1-1/4" Drop Base...	140.99 ea.
KN-66-3070	1967-81 14X5", 1-1/4" Drop Base...	187.99 ea.

X-Stream w/ Raised Base

KN-66-3000	1967-81 14X2 5/16", 9/16" Raised Base.....	174.99 ea.
KN-66-3010	1967-81 14X3", 9/16" Raised Base.	140.99 ea.
KN-66-3020	1967-81 14X4", 9/16" Raised Base.	187.99 ea.
KN-66-3030	1967-81 14X5", 9/16" Raised Base.	203.99 ea.

X-Stream Lid Only

KN-66-1401XB	1967-81 14" w/ Blue Trim Ring.....	89.99 ea.
KN-66-1401XP	1967-81 14" w/ Chrome Trim Ring...	80.99 ea.
KN-66-1401XR	1967-81 14" w/ Red Trim Ring.....	89.99 ea.
KN-66-1401	1967-81 14" w/ Black Trim Ring.....	72.99 ea.

Replacement Air Filter Only

KN-E3750	1967-81 14x4 Washable Filter.....	66.99 ea.
KN-E3760	1967-81 14x5 Washable Filter.....	75.99 ea.
KN-E3770	1967-81 14x6 Washable Filter.....	91.99 ea.

Recharger Care Kits

KN-99-5000	1967-81 w/ Aerosol Can.....	13.99 ea.
KN-99-5050	1967-81 w/ Squeeze Bottle.....	13.99 ea.

No Volume Discount.

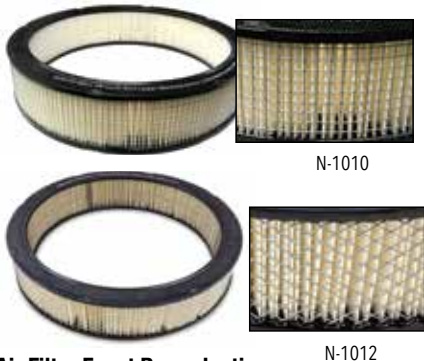

Air Filter Exact Reproduction

OE style reproduction of the original style with "square mesh" design and original GM wording (silkscreened) or AC Delco replacement style air filters.

N-1010	1970-74 Air Filter Horizontal Mesh.....	32.95 ea.
N-1012	1967-69 Air Filter Diagonal Mesh.....	32.95 ea.
ACW-212	All 14" AC Delco.....	10.95 ea.



FLOW-615101



Flowmaster Delta Force Cold Air Intakes

Unique Slip-Seal housing-filter-tube interface for a seamless installation. 4-layer dry air filter eliminates use of filter oils. Factory mounting locations for simple installation and designed to match the engine compartment for a stealthy appearance. Extensively dyno-tested for maximum performance.

FLOW-615101	2010-15 6.2L Black.....	309.99 ea.
FLOW-615104	2012-15 3.6L Black.....	313.99 ea.
FLOW-615102	2016-18 6.2L Black.....	284.99 ea.
FLOW-615103	2016-18 3.6L Black.....	313.99 ea.
FLOW-615143	2016-17 2.0L Black.....	341.99 ea.
FLOW-615025	2016-18 6.2 Air Filter Only.....	63.99 ea.

**Air filter insert for factory airbox only. No volume discount.*



Wing Nuts, Flame Arrester & Studs

APX-1400	Chrome Wing Nut.....	4.95 ea.
APX-7700	Black Wing Nut.....	4.95 ea.
ATE-5695	Flame Arrester.....	8.95 ea.

Carburetor Studs

APJ-2153	All w/Holley Open Element, 1.5".....	12.95 ea.
APJ-4153	All w/Cowl Induction.....	12.95 ea.
AP-315	All w/Q-Jet, 3 3/8".....	12.95 ea.
ATE-5256	Universal w/Point End, 4 1/4".....	8.95 ea.



HOJ-396-DC

Diecast Air Cleaner Decals

HOJ-(engine)-DC Diecast.....69.99 ea.
Ex. HOJ-396-DC for the decal above.



HOJ-375-DC

Diecast Turbo Jet Decals

HOJ-(Horsepower)-DC Diecast.....49.99 ea.
Ex. HOJ-375-DC for the decal above



Eddie Motorsports Billet Throttle Cable Brackets

These Eddie Motorsports billet GM throttle cable brackets mount to the base of Holley carburetors. The kit includes the cable mount bracket, return springs and bracket and installation hardware.

With 4150/4160 Series Carburetor

MS142-08B	1967-87 Blue.....	77.99 kit
MS142-08R	1967-87 Red.....	77.99 kit
MS142-08BA	1967-87 Black Anodized.....	77.99 kit
MS142-08CA	1967-87 Clear Anodized.....	77.99 kit

With 4500 Series Carburetor

MS142-09B	1967-87 Blue.....	102.99 kit
MS142-09R	1967-87 Red.....	102.99 kit
MS142-09BA	1967-87 Black Anodized.....	102.99 kit
MS142-09CA	1967-87 Clear Anodized.....	102.99 kit

No Volume Discount.



ACL-1267

Air Cleaner Rubber Seal

OE style reproduction rubber seal.

ACL-1267 1967-6921.99 ea.



AQW-293

Extension Seal Ring

OE style reproduction of the correct extension seal ring used for flange and seal.

AQW-293 1967-69 30229.99 ea.
 ACX-673 1967-69 SB except 30228.99 ea.



ACL-1295

Air Cleaner Flange

Correct steel flange for sealing the top of the air cleaner.

ACL-1295 1967-6927.99 ea.



AP-4B

Air Cleaner Gasket

Correct paper gasket for sealing air cleaner base to carburetor.

AP-2B All 2 bbl 3.95 ea.
 AP-4B All 4 bbl 4.95 ea.



ADR-476

Accelerator Arm & Rod

Correct throttle arm and rod for attaching it to the accelerator pedal for all 1967-69 Camaros.

A-9801 Thru-Rod26.99 ea.
 ADR-096B 1967 Big Block32.99 ea.
 ADR-476 Arm w/o Cowl Induc19.99 ea.
 ACI-3335 Arm w/ Cowl Induc18.99 ea.



Accelerator Cables

New GM service replacement cables with casings and bushings as original.

ATH-XR 1967-69 Cross Ram195.95 ea.
 ATH-6996 1970-81 All SB 4 bbl49.95 ea.
 ATH-3369 1970-81 All w/ Holley*41.95 ea.
 336969R 1970-81 Holley Repro18.95 ea.
 3972679R 1970-81 Q-Jet Repro18.95 ea.
 AZC-88 Cable Clip6.95 ea.
 AXJ-CE Cable Decal4.95 ea.
 ATH-99-BOLT 1967-690.25 ea.

*for use with ADT-0014 or 3972619 bracket.

No Volume Discount.



APJ-1302

1967-69 Accelerator Rod Kits

For those using rods, our kits come complete with pre-bent rod, swivel, grommet, sleeve and hardware.

NA-103 All 4 bbl Q-Jet29.99 kit
 APJ-1302 All Z/28 Holley29.99 kit
 APJ-1369 All BB Holley29.99 kit



3992376

Accelerator Brackets

Your choice of brackets with GM numbers or without GM numbers. Both fit as original.

3992376 w/ Q-Jet GM #'s32.95 ea.
 3972619 w/ Holley GM #'s32.95 ea.
 AXK-68 w/ Q-Jet No #'s22.95 ea.
 ADT-0014 w/ Holley No #'s19.95 ea.



ATH-3369KIT-H

Accelerator Cable & Bracket Kit - All BB/SB with SHP Holley

This new accelerator cable and bracket kit is the perfect solution for smooth operation when your originals are either worn or missing. This kit includes a reproduction accelerator cable, bracket and retaining clip.

ATH-3369KIT-H 1968-81 All41.27 kit

No Volume Discount.



GCS-S9619

GCS-S9620

Chrome Throttle Cable Brackets

Designed to work with your GM throttle cable on most carburetor applications. Available with or without kickdown provision.

GCS-S9619 w/o Kickdown7.99 kit
 GCS-S9620 w/ Kickdown8.49 kit

Note: Due to the universal nature of this part, fitting and/or modifications may be required.



DEMON-1900

Demon Carburetors

WICKED POWER! The ALL NEW Street Demon® redefines the street carburetor with clean looks and ease of use! The Street Demon offers enthusiasts a straight forward carburetor designed to deliver a stable idle, amazingly crisp throttle response and smooth performance. Its optimized calibration and dual mounting pattern make it Run-Ready™ Designed for use on most stock to mildly modified V8s! These carbs feature vacuum secondaries and an electric choke.

625 CFM Carburetors

DEMON-1900 Silver, w/ Aluminum Float Bowl ... 320.99 ea.
 DEMON-1901 Silver, w/ Composite Float Bowl ... 320.99 ea.
 DEMON-1901BK Black w/ Aluminum Float Bowl 386.99 ea.

750 CFM Carburetors

DEMON-1903 Silver w/ Aluminum Float Bowl ... 355.99 ea.
 DEMON-1904 Silver w/ Composite Float Bowl ... 355.99 ea.
 No volume discount.

Holley

HOL-0-1850SA



Holley Carburetors

Holley is one of the most trusted carburetors of all time! Its 600 CFM of airflow, vacuum secondaries, single fuel inlet and mechanical or electric choke makes it amazingly universal. The 4160 carbs are constructed from aluminum which compared to its zinc counterpart equates to a weight savings of 40%! Being aluminum also means it will hold its shine and can be hand polished for a custom look! Don't trust your performance to just anyone, Holley is the only modular carburetor company that has been in business for over 100 years and has powered every NASCAR champion since the 60's.

HOL-0-1850SA All 4160 600 CFM Manual Choke335.99 ea.
 HOL-0-80457SA All 4160 600 CFM Electric Choke341.99 ea.
 HOL-0-80670 All 4150 670 CFM Electric Choke470.99 ea.

No volume discount.



Quick Fuel Technology Carburetors

"Innovators in fuel systems" is more than just a by-line. Quick Fuel Technology, since its inception in 1998, has grown exponentially in its 11 years of business culminating into the benchmark by which performance carburetors are measured.



QF-HR-600



QF-SS-650



QF-Q-750

The Hot Rod Series is a versatile performer designed for the most discerning street enthusiast. Featuring lightweight die-cast aluminum components, the HR-Series offer all the tunability you would expect from more expensive racing carburetors, including changeable bleeds, idle feed, power valve channel restrictions, and four-corner idle. Offered in either vacuum or mechanical secondary models, all Hot Rod Series carburetors feature electric chokes and dual metering blocks for added performance. Now available in a 450 cfm model for applications with small displacement engines.

- All models feature a fully adjustable electric choke for easy starting
- Dual metering blocks w/ 4-corner idle for smooth and efficient idle quality
 - Screw-in air bleeds and idle feed restrictions for quick unsurpassed tuning capability
- Dual inlet fuel bowls with sight glass windows for safe, easy float adjustment
- Universal throttle lever with sealed throttle shafts for smooth operation
 - Tuneable secondary opening rate
 - Tumble polished for long lasting shine

4150 Carburetors Square Bore

QF-HR-600	600CFM Mechanical.....	491.99 ea.
QF-HR-650	650CFM Mechanical.....	491.99 ea.
QF-HR-750	750CFM Mechanical.....	543.99 ea.
QF-HR-850	850CFM Mechanical.....	577.99 ea.
QF-HR-680-VS	680CFM Vacuum.....	472.99 ea.
QF-HR-780-VS	780CFM Vacuum.....	489.99 ea.

No volume discount.



QF-SL-450-VS

Slayer Series street carburetors are designed with many of the same innovations and features that are built into all QFT™ race-winning carburetors, including changeable air bleeds and power valve channel restrictions. It's designed with a secondary metering plate with changeable jets, and features all aluminum components for additional weight savings. All Slayer Series carburetors are equipped with universal throttle lever to accommodate a variety of models.

- Vacuum Secondaries • Electric Choke
- Single Metering Block • Secondary Metering Plate
- Cast Aluminum Throttle Body • Single Sight Glass Windows
- Changeable Air Bleeds • Adjustable Needles & Seats

4160 Carburetors Square Bore Dual Inlet

QF-SL-450-VS	450CFM Vacuum.....	340.99 ea.
QF-SL-600-VS	600CFM Vacuum.....	340.99 ea.
QF-SL-750-VS	750CFM Vacuum.....	369.99 ea.

4160 Carburetors Square Bore Single Inlet

QF-SL-1957E	600CFM Vacuum Silver.....	340.99 ea.
QF-BD-1957	600CFM Vacuum Black.....	413.99 ea.

No volume discount.

Super Street Series carburetors combine street-friendly drivability and track-capable performance in a single value-oriented package. Setting them apart from ordinary street carbs, they feature billet dual metering blocks and throttle-bodies that offer tighter tolerances and eliminate porosity. Not only are Super Street Series carbs available with both vacuum or mechanical secondaries, QFT™ also offers models designed and calibrated specifically for E85 fuel and blow-through forced induction applications. Running alternative fuel or boost no longer requires an expensive custom carburetor. All SS-Series carburetors are equipped with universal throttle levers to accommodate a variety of models. Bolting on the ultimate street/strip carburetor has never been easier.

- Red billet dual metering blocks & silver billet throttle bodies for improved durability
- Changeable idle, high-speed air bleeds & power valve restrictions
- Dual inlet fuel bowls with dual sight glass windows for easy float adjustment
 - 4-Corner idle for precise idle and smooth transition
 - Fully-adjustable electric choke with easy one wire hookup
 - Race-ready with notched secondary floats and jet extensions
 - Polished or Black Diamond™ finish available (some models)

4150 Carburetors Square Bore

QF-SS-650	650CFM Mechanical Silver.....	660.99 ea.
QF-SS-750	750CFM Mechanical Silver.....	660.99 ea.
QF-SS-850	850CFM Mechanical Silver.....	660.99 ea.
QF-BD-750	750CFM Mechanical Black.....	710.99 ea.
QF-SS-680-VS	680CFM Vacuum Silver.....	614.99 ea.
QF-SS-780-VS	780CFM Vacuum Silver.....	614.99 ea.

No volume discount.



QF-SQ-650

Street-Q carburetor is intended to deliver legendary Q-Series performance to hardcore street enthusiasts at a reduced price. The major differences between the Street-Q and the race-bred Q-Series is the substitution of cast metering blocks and a cast throttle body in place of fully-machined billet components. All of the critical functionality is retained - 2-circuit metering, downleg boosters, changeable idle and high-speed air bleeds and 4-corner idle. A universal throttle lever to accommodate a variety of models.

- Lightweight die-cast aluminum components
- Changeable idle and high-speed air bleeds
- 2-circuit metering - 4-Corner idle system
 - Downleg boosters
 - 700-R4 mounting holes

4150 Carburetors Square Bore

QF-SQ-650	650CFM Mechanical Silver.....	526.99 ea.
QF-SQ-750	750CFM Mechanical Silver.....	566.99 ea.
QF-SQ-850	850CFM Mechanical Silver.....	582.99 ea.
QF-SQ-950	950CFM Mechanical Silver.....	595.99 ea.

No volume discount.

Q-Series Race carburetors are purpose-built for the dragstrip. To combat the g's experienced during hard launches, Q-Series carbs are equipped with notched floats and secondary jet extensions. The high-flow aluminum main body isn't just lightweight, but it also features recessed air bleed cavities for improved air flow. Die-cast venturi are machined to exacting tolerances for outstanding throttle response. Billet metering blocks ensure a uniform fuel curve, while throttle-bodies enhance durability. For those days when track conditions vary from one pass to the next, QFT's QuickLink system makes adjusting the secondaries easy on models equipped with mechanical secondaries. The Q-Series is our most comprehensive line of carburetors, with applications available for use with gasoline, methanol, and E85 fuels, forced induction, drag race, circle track, and comes in both vacuum and mechanical secondary models.

- Lightweight aluminum main body
 - Mechanical secondary
- Aluminum fuel bowls with dual sight glass windows
- Billet metering blocks with 4-corner idle system
- Changeable idle feed and power valve channel restrictions
- PTFE coated and sealed shafts that have been slabbed for added air flow
- Red anodized billet metering blocks and throttle plate

4150 Carburetors Square Bore

QF-Q-750	750CFM Mechanical Silver/Red.....	764.99 ea.
QF-Q-750-B2	750CFM Mechanical Silver/Red*.....	819.99 ea.
QF-Q-850	850CFM Mechanical Silver/Red.....	819.99 ea.
QF-Q-950	950CFM Mechanical Silver/Red.....	873.99 ea.
QF-BDQ-750	750CFM Mechanical Black/Black.....	819.99 ea.

*Draw thru supercharger applications with 2 carbs.
No volume discount.



QF-FX-4710

QFX-Series stands as the flagship model in QFT's lineup. Raised air horns improve entry angle into the venturi while ensuring undisturbed flow over the air bleeds. Annular boosters with CNC-machined billet aluminum inserts provide increased air flow, a stronger signal, and less turbulence. QFX carbs offer unparalleled fuel atomization with annular boosters specific for either gas, methanol, or E85 fuels. Five-emulsion billet metering blocks and four-corner idle circuits offer flexible tuneability that today's high-horsepower engines demand. Ready to run out of the box, the QFX-Series carburetor will help you get to the winner's circle.

- QFX aluminum main body w/raised venturi
- Billet aluminum metering blocks with screw in restrictions
- Aluminum fuel bowls with dual sight windows and fuel inlets
 - Viton .130" Needles and Seats
- Billet Aluminum annular booster inserts
- QuickLink™ adjustable secondary opening adjustment
 - Hand assembled and engine tested

4500 Spread bore Dominator Style

QF-FX-4710	1150CFM Mechanical Black/Black.....	1108.99 ea.
------------	-------------------------------------	-------------

No volume discount.

CARBURETOR ACCESSORIES



AFP-4221

Carburetor Base Gaskets & Shields

Correct "stamped" gasket and stainless steel shield.

Gaskets

AFP-4221	1967-69 4 bbl. Q-Jet.....	6.95 ea.
AFP-4219	1970-72 4 bbl. Q-Jet.....	6.95 ea.
AFP-4222	1967-72 All Holley.....	6.95 ea.

Shield

ABB-7401	1967+ All Q-Jet.....	12.95 ea.
----------	----------------------	-----------



ABB-HOLY

Holley Carburetor Heat Shield

Fits all standard 4150 and 4160 4 bbl Holley carburetors. Features original part number and the common Chevy firing order.

ABB-HOLY	1967-92 With Holley	33.99 ea.
----------	---------------------------	-----------

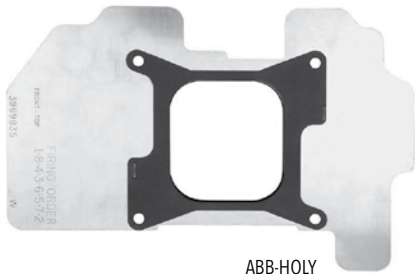

AS-761



AS-166



ACS-0069



ATE-0068



ACS-7454

Carb Return Springs

New correct color coded springs.

AS-761	1967-69 Q Jet Black	9.95 ea.
AS-166	1967-68 Holley Green	8.95 ea.
ACS-0069	1969 Holley Green	8.95 ea.
ATE-0068	1970-81 Q Jet Black	8.95 ea.
ACS-7454	1970-81 Holley Blue	9.95 ea.



GCS-S2083

Chrome Holley Carburetor Throttle Return Kit

Designed to make mounting the spring a snap! Works on most Holley carburetor applications. *Modifications may be required.*

GCS-S2083	Holley	11.99 kit
-----------	--------------	-----------



BMG-0095

Carb Attaching Kits

Correct OEM bolt kit for attaching carburetor to intake manifold.

BMG-0095	All w/ Holley	7.95 ea.
BTE-1475	All w/ Q-Jet.....	8.95 ea.



APX 1115

Engine Block Lifting Ring

These correct steel stamped lifting rings were installed at the engine plant for ease of installation.

APX-1015	Most SB	25.95 set
APX-1115	All BB	25.99 set
BPX-230	Lifting Ring Bolt.....	0.95 ea.



WND-8120WND

Weiand Street Warrior Intake Manifolds

The Weiand Street Warrior is designed for use on stock or stroker combinations that feature efficient cylinder heads. The latest advances in cam design necessitated the design of a new intake manifold, and the Weiand Street Warrior manifolds fill that void.

Square Bore Carburetors

WND-8120WND	Small Block w/ 55-86 Heads	165.99 ea.
WND-8121	Small Block w/ Vortec Heads	207.99 ea.

Spread Bore Carburetors

WND-8126	Small Block w/ 87-95 Heads	207.99 ea.
----------	----------------------------------	------------

No volume discount.

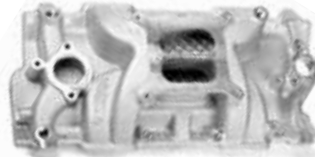

WND-8150

Weiand Speed Warrior Intake Manifolds

The Weiand Speed Warrior features long, separated runners for bottom-end and mid-range power, plus a special runner design and larger plenum to flow the air needed for high-rpm horsepower. All of this usable power makes this intake perfect for your street and strip hot rod!

WND-8150	Small Block W/55-86 Heads.....	177.99 ea.
WND-8170WND	Small Block W/87-95 Heads.....	188.99 ea.

No volume discount.



BPI-9140



BPI-2271

Intake Manifold Bolts OEM

Our OEM intake bolts feature correct size, coloring and head markings.

BPI-4400	All SB "M" Flanged 12pc	16.95 kit
BPI-9140	All BB "M" Cast Intake 16pc.....	21.95 kit
BPI-2271	All BB "A" Aluminum Intake 16pc.....	25.99 kit



BPS-3679



BPS-7432

Intake Studs

Correct intake manifold studs for various uses: alternator, solenoid and power brake tube. Includes correct nut.

BPS-3679	All 3/8" x 3/8" (Zinc).....	6.99 ea. (p.s. bracket, alternator mount, etc.)
BPS-7432	All 5/16" x 3/8" (Black).....	3.95 ea. (TCS, P.B. tube, etc.)



ACK-1679

Choke Kits

New OE style reproductions! Our kits come complete with thermal coil, cover, rod, retaining clip and screw.

ACK-1679	1967-69 SB Q-Jet	36.95 kit
ACK-6772	1967-71 Z/28.....	36.95 kit
ACK-8889	1967-69 BB Q-Jet.....	36.95 kit
ACK-1669	1967-69 BB Holley	36.95 kit
ACK-7072	1970-72 BB Q-Jet.....	36.95 kit
ACK-7071	1970 BB Holley.....	36.95 kit



APN-0138



APN-0238



APN-0038



APN-638



APN-738



APN-838

Intake Manifold Vacuum Fittings

OE style reproduction. These high quality fittings for rear of intake manifold have correct "slip on" and threaded ends. These fittings have a variety of uses: power brake hose, auto transmission, air conditioning, cruise control, etc. Guaranteed to look, fit and function exactly as original.

APN-0138	(1) Slip On Fitting.....	17.99 ea.
APN-0238	(2) Slip On Fittings	15.99 ea.
APN-0038	(1) Threaded Port.....	15.99 ea.
APN-638	(1) Threaded (1) Slip On	20.99 ea.
APN-738	(1) Threaded (2) Slip On	23.99 ea.
APN-838	(1) Threaded (3) Slip On	29.95 ea.



N-1252

Oil Filler Tube

Intake oil filler tube used with screw in PCV filter.

N-2258	1967-68 327 Black.....	36.95 ea.
N-1252	1967 SS350 / Z/28 Chrome.....	42.95 ea.
N-2290	1968 SS350 / Z/28 Chrome.....	51.95 ea.



AOC-1254



AOC-1689

Oil Filler Tube Cap

Correct twist on cap with "S" rivet.

AOC-1689	1967-68 327 Black.....	11.95 ea.
AOC-1254	1967-68 SS350 / Z/28 Chrome.....	17.95 ea.



AC-69SHP

1969 SHP PCV Valve

Correct purple PCV valve for Special High Performance engines.

CAC-69SHP	1969 w/ SHP.....	23.95 ea.
-----------	------------------	-----------

CPX-9038

BUY'N SAVE

WITH KITS

PCV Hose & Filter Kit

Our kits come complete with correct GM hose, AC Delco filter and correct black pinch clamp. Pieces also available separately.

CPX-9038	All Complete.....	16.82 kit
CPH-9038	Hose Only.....	11.95 ea.
CTC-1132	Pinch Clamp Only.....	0.50 ea.
CAC-3800	PCV Filter Only.....	5.95 ea.



CPN-3819

AX-2963

PCV Retaining Hose Clip

OE style reproduction of original PCV hose retaining clip, with correct bends and black phosphate coating.

CPN-3819	1967-72 Z/28.....	16.99 ea.
CPN-3819	1967-69 BB w/ Holley.....	16.99 ea.
AX-2963	1967 BB Q-Jet.....	13.95 ea.

1114432



TCS Solenoid

Correct TCS solenoid which mounts to the carburetor stud. Includes correct brackets.

1114432	1970-71 350/400.....	104.95 ea.
1114434	1970 BB.....	104.95 ea.



APX-3002

Vacuum Advance Kits

Our kits come complete with correct pre-bent tapered tube(s), correct white stripe vacuum hose and correct clip.

APX-3002	1967-69 SB 2 bbl.....	20.99 kit
APX-3042	1967-69 SB 4 bbl.....	20.99 kit
APX-2628	1967-71 SB Holley.....	20.99 kit
APX-3940	1967-69 BB Q-Jet.....	21.99 kit
APX-3946	1967-69 BB Holley.....	20.99 kit



APX-4946K

1970 TCS Vacuum Advance Kits

This one year only design utilized two steel tubes and a double clip.

APX-3944K	1970 BB Q-Jet TCS.....	29.99 kit
APX-4946K	1970 BB Holley TCS.....	29.99 kit



APR-4060

AX-301

CPN-100

Vacuum Advance Clips

Correct clip for retaining tube to intake manifold.

APR-4060	All V8.....	8.95 ea.
AX-301	1970 w/ TCS.....	13.95 ea.
CPN-100	Hose.....	1.95 per ft

THERMOSTAT

Tuff Stuff Performance Thermostats

These thermostats flow up to 56 gallons per minute, as compared to ordinary thermostats that flow 37 gallons per minute, to maintain stated temperature. The 50 percent increased coolant flow reduces the delay in engine warm-up times, allowing trapped air in the cooling system to escape and stabilize the pressure of the cooling system. The stainless steel construction with an extra-large center port assures increased coolant flow and bridge design increases strength, stability & reliability and incorporates a bypass valve that allows a small amount of coolant to circulate before fully opening, assuring a fast warm-up. Ideal for high performance muscle cars, street rods and customs.



TUF-900160	160 Degree.....	17.99 ea.
TUF-900180	180 Degree.....	17.99 ea.
TUF-900195	195 Degree.....	17.99 ea.

No volume discount.



ACT-180

Thermostat

Original AC-Delco thermostat.

ACT-180	180-85 Degrees.....	6.95 ea.
ACT-190	190-95 Degrees.....	6.95 ea.



ABR-7660

Thermostat Housing

Correct thermostat housing for cast iron manifolds. This was the most common housing and was found on most V8's.

ABR-7660	Most V8.....	14.95 ea.
----------	--------------	-----------



ACI-7660

Thermostat Housing

Correct thermostat housing for high performance engines with aluminum intake manifolds. GM #3877660.

ACI-7660	Aluminum.....	45.99 ea.
----------	---------------	-----------



ATE-7396

Z/28 Thermostat Housing

This is the correct gooseneck style thermostat housing for your Z/28 engine.

ATE-7396	1967-68 Z/28.....	59.95 ea.
----------	-------------------	-----------



GCS-S9229

Chrome Thermostat Housing

Chrome steel thermostat housing with o-ring and bolts. Water neck points toward the driver side of the radiator.

GCS-S9229	Most V8.....	11.04 kit
-----------	--------------	-----------



ATR-1039

ATR-2039

Thermostat Housing Bolts

Correct TR head marked bolts for attaching to intake.

ATR-1039	1969+ SB.....	7.95 ea.
ATR-2039	1967-74 BB.....	7.95 ea.

IGNITION



A2525 1971244



Distributor Cap

Choose from AC Delco replacement distributor cap or exact reproduction distributor cap with GM numbers. Red cap features heavy duty brass terminals for high performance engines.

A2525	Red Cap.....	79.95 ea.
1971244	Black Cap.....	69.95 ea.
AAD-308	Replacement.....	22.95 ea.



ADS-2100-SC-CLEAR

ADS-2100-SC-RED

HEI Distributor

HEI Electronic Distributor with 50K Coil - Red Cap

ADS-2100	All.....	72.99 ea.
ADS-2100-SC-RED	Red Super Cap.....	102.99 ea.
ADS-2100-SC-CLEAR	Clear Super Cap.....	108.99 ea.



ACCEL-59107

Accel Replacement HEI Distributor

Using all new components, these distributors feature: High performance ACCEL Electronics. All new components-housing castings, ce. Direct plug in replacement with factory type connector. Fits standard deck height small and big block engines. Coil Not Included!

ACCEL-59107	All w/ HEI.....	107.99 ea.
-------------	-----------------	------------

No volume discount



MSD-8360

MSD Pro Billet Distributor

The Pro-Billet Ready-to-Run distributor is the perfect upgrade for outdated points distributors or bulky HEIs. Simply install the distributor in the engine, connect three wires, the coil and fire it up!

MSD-8360	Chevy V8*.....	361.99 ea.
MSD-85551	Chevy V8**.....	281.99 ea.

*Does not have nor can accept a vacuum advance canister.

**Must be used with a MSD 6,7, or 8 ignition box.

Note: Standard deck height blocks only. Will not fit gen 5 and 6 big blocks. No volume discount.



MSD-8362

MSD HEI Distributor

For value conscious enthusiasts, the Street Fire HEI is a great choice! We know the importance of a centrifugal advance in a distributor so our engineers made sure that the Street Fire received an advance assembly with coated weights and welded weight pins (not just pressed in like other models). Another area that you cannot afford to scrimp on is with a distributor gear. The Street Fire is fit with the same gear that is used on our Pro-Billet models. The metallurgy of this gear has been refined for years to perform through the harshest conditions

MSD-8362	All, Red Cap 4 Pin*.....	167.99 ea.
MSD-8365	All Billet, Red Cap 4 Pin*.....	448.99 ea.

Note: Standard deck height blocks only. Will not fit gen 5 and 6 big blocks.*Refers to the amount of terminals on the ignition module. No volume discount.



MAL-374820

Mallory Unilite Distributor

A legend returns - the tried and true Mallory Unilite Distributor line is back! The easy three wire hookup of the Unilite makes running a stock coil, a Mallory performance coil and even a Mallory HyFire CD ignition a snap. Supplied with a quality cap and rotor, the Mallory Unilite also provides a fully adjustable mechanical advance to dial in the perfect timing curve for a multitude of engine combinations. The Unilite features a compact housing that lends itself well to applications where space is a premium due to tight firewall clearance or blower applications.

MAL-3748201	All SBC, BBC*.....	318.99 ea.
-------------	--------------------	------------

*Standard deck height blocks only. Will not fit gen 5 and 6 big blocks. No volume discount.



ACE-1400

Distributor Hold Down

Correct retaining hardware for distributors.

ACE-1400	All V8.....	4.95 kit
----------	-------------	----------



GCS-S4116

GCS-S5116

Custom Distributor Hold Down Kit

Designed to secure your distributor settings and look good doing it. Choose from chrome or billet.

GCS-S4116	Chrome.....	3.99 ea.
GCS-S5116	Billet.....	15.29 ea.

N-2441



Tune Up Kit

AC Delco tune up kit with new points, condenser and rotor.

N-2441	1967-74 w/o HEI.....	45.95 ea.
--------	----------------------	-----------



1115263 (Top View)

1115270

Coil

Choose from our new exact reproduction Delco coils with GM numbers or GM replacement coil.

1115287	1968-72 BB.....	139.95 ea.
1115270	1968-72 SB.....	139.95 ea.
1115263	1967-72 Trans. Ign.*.....	149.95 ea.
1115293	1970-72 Most V8.....	139.95 ea.
GAC-505	1967+ Most Replace.....	39.95 ea.

*427/454 transistor ignition. No Volume Discount.



ALI-3119

BAN-516

Coil Bracket

OE style reproduction of original comes with retaining screw.

ALI-3119	All V8	19.99 ea.
BAN-516	Correct SEMS Bolts	1.95 pr.



GCS-S9366

Chrome Ignition Coil Bracket

This brightly chrome plated ignition coil bracket will look great in your engine compartment. Fits most round cylinder style ignition coils.

GCS-S9366	Coil Bracket	7.19 ea.
-----------	--------------------	----------



MSD-6201

MSD Ignition

An MSD Ignition will improve the overall performance of your engine thanks to its high output capacitive discharge sparks. Below 3,000 rpm the ignition delivers multiple sparks that will clean up the idle, improve starting and throttle response. If you're looking to improve the performance of your modified mill, we have the answer. Whether you've done a cam swap, or bolted on a carb, intake and headers the 6A is a surefire way to harness all the ponies under your hood. Step up to the 6AL to have an engine saving rev limiter.

MSD-6201	Red All 6A	232.99 ea.
MSD-6425	Red All 6AL	269.99 ea.
MSD-64253	Black All 6AL	269.99 ea.
MSD-6421	Red All 6AL-2	321.99 ea.

No volume discount.



MSD-35593



MSD-31359



MSD Ignition Spark Plug Wires

Engineered from the inside out, the 8.5 offers everything you have ever wanted in a wire; incredibly low resistance without electronic interference! In a single 12 inch length of Super Conductor Wire there is only 40 - 50 ohms of resistance!

Without Headers

MSD-31359	Red, SBC 350 HEI	94.99 kit
-----------	------------------------	-----------

With Headers

MSD-35593	Black, SBC 350 HEI* Cap	97.99 kit
MSD-35599	Red, SBC 350 HEI* Cap	97.99 kit
MSD-35603	Black, BBC 350 HEI* Tower Cap	101.99 kit
MSD-35609	Red, BBC 350 HEI* Tower Cap	101.99 kit
MSD-35653	Black, SBC 350 HEI* Tower Cap	99.99 kit
MSD-35659	Black, SBC 350 HEI* Cap	99.99 kit

*Works on any HEI or MSD style cap with male terminals.

No volume discount.



ALL-70BB3Q

"Dated" Spark Plug Wire Set

New OE style reproduction wire set correctly dated for your specific car, pre-cut and ready to install! Each set features correct colored wires and correct angled boots. Please give your sales rep your desired date. For points style, non-HEI cars only.

Here's how to order:

ALL-(year)(block)(quarter)

79.99 set
Note: For example, a 1970 Camaro SS396 built on or before Jan. 15, 1970, you would order ALL-70BB3Q wires will have 3-Q-69 stamped on them. If built after Jan. 15, 1970, you would order ALL-70BB1Q.



AHC-1508

Spark Plug Wire Sets

Pre-cut factory replacements.

AHC-1508	1967-73 SB non-HEI	39.95 set
AHC-2508	1967-72 BB non-HEI	39.95 set
AHC-3508	1974-81 with HEI	52.95 set



AC43

AC Delco Spark Plugs

This is a brand new set of 8 spark plugs for your Camaro. These high quality reproduction AC Delco spark plugs feature the correct green AC and markings as original.

AC43	1964-70 #43	59.95 set
AC44	1964-70 #44	59.95 set
AC45	1964-70 #45	59.95 set

Note: The number on the plug refers to its operating temperature. The lower number is a cooler running plug which is typically found on the SHP high performance engines. A hotter, higher numbered plug would be used in engines where plug fouling may be or is a problem.



APX-6584

Spark Plug Heat Shield Kit BB

Correct stamped shields for various Chevrolet cars with BB engines (8 pcs.)

APX-6584	1967-72 BB 8pc	38.95 kit
----------	----------------------	-----------



AT-3030

OEM Style Spark Plug Heat Shield Kit BB

This is a set of correctly stamped spark plug heat shields which are silver cadmium plated.

AT-3030	1967-72 BB	49.95 kit
---------	------------------	-----------



APX-650

Spark Plug Heat Shield Kit SB

Correct die stamped shields and arms for most small blocks without Rams Horn style manifolds. Complete with mounting hardware.

APX-650	1967-74 SB.....	36.95 kit
BXX-650	Bolts (4).....	1.00 kit



APX-5022

Valve Cover Spark Plug Wire Loom Kits

Correct spark plug wire separators for valve covers

APX-5022	SB 6pc.....	19.95 kit
APX-5023	BB 4pc.....	11.95 kit



APX-1300 APX-8100 APX-1200

Wire Separators

Correct spark plug wire separators

APX-1300	1969-72 SB/BB Left Rear.....	16.95 ea.
APX-1200	1969-74 SB Left Front.....	17.99 ea.
APX-8100	1968+ BB Right Side.....	15.95 ea.



AX-423 AX-486A

Spark Plug Wire Stands

New OE style reproduction of originals

AX-423	All SB RH.....	14.95 ea.
AX-67R	1967 SB LH.....	26.95 ea.
AX-486A	1968 All SB LH.....	27.95 ea.
AX-486	1969-72 All SB LH.....	27.95 ea.
AX-ZZ	1969 Z/28 LH.....	26.95 ea.
AX-7Z	1970-73 SB LH.....	26.95 ea.



GCS-S4973

Vacuum Advance Cover

This vacuum advance pod cover will give your distributor that show car look. Fits most GM distributors.

GCS-S4973	Chrome.....	3.99 ea.
-----------	-------------	----------



APJ-5240

Ground Strap Kit

Correct braided copper wire and ends complete with OEM screws

APJ-5240	1967-68 3pc.....	19.95 kit
APJ-5230	1969 4pc.....	23.95 set



AJ-850

Timing Covers

New covers complete with crankshaft seal.

AJ-408	1967-76 All Small Block.....	48.95 ea.
AJ-850	1967-72 All Big Block.....	46.95 ea.
BTC-650	Correct Attaching Bolts.....	8.95 kit



ATP-35

Timing Cover Pointers

Correct pointer for adjustment of engine timing

ATP-35	1967-68 SB.....	8.95 ea.
ATP-36	1969-72 SB.....	10.99 ea.
ATP-47	1967-72 SB w/ 7" Bal.....	19.99 ea.
ATP-07	1967-72 BB.....	7.99 ea.



GCS-S9178

Chrome Adjustable Timing Pointers

Provides a convenient way to adjust and verify your engine's ignition timing. Finished brilliant chrome plated steel.

GCS-S9178	SB 7".....	6.39 ea.
GCS-S9179	SB 8".....	6.39 ea.
GCS-S4961	BB 8" Non Adjustable.....	3.19 ea.
GCS-S9180	BB 8".....	3.99 ea.



GCS-S6040C

2 Piece Aluminum Timing Covers

An excellent upgrade for your engine. Rigid sealing surface for positive seal and it looks great, too!

GCS-S6040	SB Polished Billet.....	16.79 ea.
GCS-S6040C	SB Chrome Billet.....	38.39 ea.
GCS-S8422	BB Polished Billet.....	33.59 ea.
GCS-S8422C	BB Chrome Billet.....	50.39 ea.

Note: These covers may not work with some double roller timing chains. Check clearance before starting engine. Doubling of the gaskets or shims may be required to use cover with a short water pump.



GCS-S4935

Chrome Timing Covers

Brilliantly polished timing cover with a rigid sealing surface.

GCS-S4932	SB SWP Chrome.....	16.09 ea.
GCS-S4934	SB LWP Chrome.....	16.79 ea.
GCS-S4935	BB All Chrome.....	16.79 ea.
GCS-S4935R	BB All Unfinished Steel.....	23.99 ea.

Note: These covers may not work with some double roller timing chains. Check clearance before starting engine. Doubling of the gaskets or shims may be required to use cover with a short water pump. SWP = Short water pump. LWP = Long water pump.



GCS-S6042C

SB Billet Timing Cover Pointer

Provides a convenient way to adjust and verify your engine's ignition timing. Adjustable and can be used with 6" or 7" balancers.

GCS-S6041	Billet.....	24.99 ea.
GCS-S6041C	Chrome Plated Billet.....	22.94 ea.
GCS-S6042	Ball Milled.....	28.99 ea.
GCS-S6042C	Ball Milled Chrome.....	24.64 ea.
GCS-S4960	Chrome Plated Steel.....	4.24 ea.



XA-101

BUY'N SAVE
WITH KITS

Valve Cover Kit Big Block

All kits come complete with the following items: (2) valve covers, (2) gaskets, valve cover retainers and TR bolts, (2) V.C. grommets, V.C. oil cap, V.C. elbow and hose and V.C. wire separators.

XA-101	w/o Left Slant.....	130.39 kit
XA-101S	w/ Left Slant*.....	130.39 kit

OE kits with silver gaskets, correct oil cap and Tonawanda decal.

XA-101-OE	w/o Left Slant.....	162.07 kit
XA-101S-OE	w/ Left Slant*.....	162.07 kit

*Use slanted valve covers when brake booster clearance may be an issue.



396TJVC-1



"Turbo Jet" Valve Covers

"Cal Custom" finned aluminum covers feature either the 396 or 427 "Turbo Jet" die cast chrome medallions.

396TJVC-1	All BB 396	229.95 pr.
427TJVC-1	All BB 427	229.95 pr.

2-5/8" - 3" inside clearance. Will work with most roller rockers.



427VC-1



"427" Valve Covers

Like our "YENKO" covers with cast "427" medallions.

427VC-1	Most BB "427"	229.95 pr.
---------	---------------------	------------

2-5/8" - 3" inside clearance. Will work with most roller rockers.



AVC-100



Baldwin-Motion & Yenko Finned Aluminum Valve Covers

We have found these original style "Cal Custom" finned covers commonly used on Yenko, Baldwin Motion, Nickey and other factory super cars.

AVC-100	Most BB.....	179.95 pr.
---------	--------------	------------

2-5/8" - 3" inside clearance. Will work with most roller rockers.

ALS-1065XT



Original Style Chrome Valve Covers

These OE style reproduction covers offer the highest quality chrome plating, correct wire stands and factory oil deflector "drippers". Valve covers are available with a left side slant to increase booster clearance in tight engine compartments. Also available in tall style to fit roller rockers.

ALS-1065	All BB w/o Slant.....	99.95 pr.
ALS-1165	All BB w/ Left Side Slant*	99.95 pr.
ACC-3362	All BB w/o Drippers	38.99 pr.
ACC-3365	All BB w/ Slant w/o Drippers*.....	31.99 pr.
ALS-1065XT	All BB Tall w/o Left Slant w/o Drippers.....	89.95 pr.
ALS-1165XT	All BB Tall w/ Left Slant w/o Drippers*.....	89.95 pr.

*Use slanted valve covers when brake booster clearance may be an issue.



ALS-1165-OJ



Big Block Valve Covers – Chevrolet Orange

This is a pair of brand new big block valve covers painted in Chevy orange. These valve covers are correct for most big blocks and will fit cars with power brakes.

ALS-1165-OJ	All Big Block.....	109.99 pr.
-------------	--------------------	------------



YSCVC-1

“Yenko” Valve Covers

These limited edition “Cal Custom” style finned aluminum covers feature the notorious “YENKO” Red, White and Blue die cast logos.

YSCVC-1 Most BB “YENKO”.....229.95 pr.
2-5/8” - 3” inside clearance. Will work with most roller rockers.



HARRELVC

Dick Harrel Aluminum Valve Covers

“Cal Custom” finned aluminum covers feature the Dick Harrell die cast medallions.

HARRELVC Most BB.....229.95 pr.
2-5/8” - 3” inside clearance. Will work with most roller rockers.



“Motion” Valve Covers

Original style Cal Custom finned valve covers featuring the notorious Baldwin Motion die cast logos.

MOTION-VC Most BB “Motion”.....289.95 pr.
MOTION-VC-BLACK Most BB “Motion” Black179.95 pr.
Note: 2-5/8” - 3” inside clearance.



ATE-4207

Finned Aluminum Valve Covers

OE style reproduction of original GM high performance valve covers.

ATE-4207 SB229.99 pr.
ATE-4207-BLK SB Black229.95 pr.
HVC-28 Flag Decal..... 8.95 ea.



AVC-540

1967 Chevrolet Script Valve Covers

Excellent reproductions of the original stamped “Chevrolet” valve covers in chrome or ready to paint EDP coating. These valve covers feature the correct wire retainers and “O” stamp.

AVC-540 Chrome169.99 pr.
AVC-541 Paintable.....129.99 pr.





AVC-542

1968 SHP Valve Covers

Accurate reproductions of the original 1968 Z/28 or SS350 high performance valve covers in chrome or ready to paint EDP coating.

AVC-542	Chrome	172.99 pr.
AVC-543	Paintable.....	129.99 pr.



GCS-9215B

Black Painted Valve Covers

This is a pair of high quality tall black painted valve covers. A great inexpensive custom touch to any street machine or sleeper!

GCS-9215B	1964-77 SB.....	31.99 pr.
-----------	-----------------	-----------



AT-3666

Small Block Valve Covers

New original style early small block Chevrolet valve covers. These covers come ready to install in correct Chevrolet orange or chrome.

AT-3662	SB Chrome	119.95 pr.
AT-3666	SB Orange.....	99.95 pr.



AFI-9797

Valve Cover Gaskets

AFP-057	All SB.....	13.95 pr.
AFP-059	All BB.....	13.95 pr.
AFI-9797	BB w/ Silver Coating.....	19.95 pr.



APB-1023

Valve Cover Retainers OEM Bolt Kits

Correct steel stamped zinc plated retainers & OEM bolts.

APB-1023	SB TR Bolts 16pc.....	14.95 kit
APB-2023	BB TR Bolts 28pc.....	23.95 kit
APB-1027	SB M Aluminum 8pc.....	16.99 kit



APO-2043



APR-2136

Valve Cover Oil Caps

Choose from either chrome GM replacement, chrome reproduction with correct "S" or black rubber push in cap.

APX-5763	Replacement.....	6.95 ea.
APR-2136	Reproduction "S".....	16.95 ea.
APO-2043	Rubber "OIL"	5.95 ea.



APB-3508



APB-3509

Valve Cover Grommet

Original GM grommets

APB-3508	All SB.....	8.99 pr.
APB-3509	All BB.....	7.95 pr.



APT-3509



APT-3960

Valve Cover Elbows

Correct GM steel valve cover elbows.

APT-3960	All SB.....	12.95 ea.
APT-3509	All BB.....	11.95 ea.



APH-3961



APH-2109

APH-3843



Valve Cover Hose

Correct marked OEM hose which extends from valve cover to air cleaner base. Choose from open or closed element.

APH-3961	All SB Open.....	11.95 ea.
APH-3843	All BB Open.....	4.95 ea.
APH-2109	1970-72 BB Closed.....	12.95 ea.

OIL SYSTEM



Holley LS Swap Oil Pan

GM's popular LS engines are finding their way into a large variety of vehicles. They make great power, plus they're very durable and reliable. Unfortunately, the factory LS pans don't always fit or they hang too low for today's hot rods. Holley's new LS Retro-fit Engine Oil Pan is designed to help! It provides maximum clearance to the chassis and ground, plus provides an OEM fitment for durability and proper sealing.

- Provides OEM fitment- OEM oil filter mounting, OEM oil cooler port provision, OEM engine NVH suppression, OEM flange gasket and sealing, proper structural rigidity and OEM bell-housing attachments.
- Traditional high-quality cast aluminum appearance with clean exterior styling.
- Provides maximum clearance to chassis
- Cast and machined aluminum
- Complete kit including sump baffle, pick-up tube, sump plug, oil filter stud & oil passage cover.
- Fits GM rear wheel drive applications that were originally equipped with a Small Block or Big Block Chevy engine and traditional rear sump oil pan*

HOL-302-2 1967-81 All 349.99 ea.
 Maximum crankshaft stroke = 4.25"
 *Engine location may need to be adjusted (up / down or fore / aft) for cross member or steering linkage clearance depending on the vehicle, steering configuration and chassis type.
 No volume discount.



AEH-999

Oil Pans

Correct OEM oil pans made in North America.

AJ-221	1967-81 SB w/o SHP.....	129.99 ea.
AEH-999	1967-72 All BB.....	199.99 ea.



ACP-15B

Oil Pan Gasket Set

Correct OEM gaskets.

ACP-15B	All SB.....	19.95 ea.
ACP-2BB	All BB.....	16.95 ea.



BOP-2002

Oil Pan Attaching OEM Bolt Kit

Correct "L" head marked bolts for attaching pan to block

- BOP-2001 All SB 18pc..... 9.95 ea.
- BOP-2002 All BB 24pc..... 13.99 ea.



BPO-1988

Oil Drain Bolt / Washer

Original GM

- BPO-1988 All SB/BB 6.95 ea.



AJ-4

Oil Pan Baffle / Windage Tray

Often installed on most High Performance cars this "windage tray" was used to keep oil from splashing the crankshaft. A MUST!

- AJ-4 Small Block 44.99 ea.
- AJ-6 Big Block 23.95 ea.



APC-744

Oil Pan Clip

Correct clip for retaining positive battery cable routing to solenoid

- APC-744 All SB-BB 5.95 ea.



Oil Dipstick Kits

Complete with tube and gauge (Stick)

- ATE-1567 1967-79 SB (Green Dot) 31.99 ea.
- ATE-1576 1967-72 BB (Yellow Dot)..... 49.95 ea.



GCS-S6060

Billet Aluminum Engine Dipstick

Show quality dipstick with billet handle. 11.5" length.

- GCS-S6060 Handle 12.79 ea.
- Note: Oil level varies depending on the oil pan used. You may need to mark the dipstick with your own new full level mark.*



GCS-S5002

Billet Engine Dipstick with Braided Tube

Show quality billet aluminum dipstick with braided tube.

- GCS-S5002 1955-79 SB 31.44 ea.
- GCS-S5001 1980-95 SB 31.44 ea.
- GCS-S5003 1965-90 BB 36.54 ea.

Note: Oil level varies depending on the oil pan used. You may need to mark the dipstick with your own new full level mark.



GCS-S4957BA

Chrome / Billet Dipsticks & Tubes

Show quality dipsticks with matching tubes. A great upgrade to any engine compartment!

- GCS-S4957 1955-79 SB, Chrome, 19" 5.39 ea.
- GCS-S4957BA 1955-79 SB, Billet, 19" 8.79 ea.
- GCS-S9420 1980-82 SB, Chrome, 23" 7.99 ea.
- GCS-S9420BA 1980-82 SB, Billet, 23" 12.99 ea.
- GCS-S9231 1983-85 SB, Chrome, 24.5" 7.99 ea.
- GCS-S9231BA 1983-85 SB, Billet, 24.5" 10.99 ea.
- GCS-S4958 1965-90 BB, Chrome, 21" 6.39 ea.
- GCS-S4958BA 1965-90 BB, Billet, 21" 8.79 ea.

Note: Oil level varies depending on the oil pan used. You may need to mark the dipstick with your own new full level mark.



NFX-25

NF-25

Oil Filter

OE style reproduction of early spin on style filter.

- NFX-25 PF-25 AC Filter "White" 24.99 ea.
- NF-25 PF-25F AC Filter "Blue" 9.99 ea.



GAC-110

Oil Pressure Switch

Correct GM switches for cars without gauges.

- GAC-110 All w/o Gauges 11.95 ea.



N-137

N-133

N-142

Oil Pressure Fittings

- N-137 1968+ All SB 6.99 ea.
- N-133 All BB w/o SHP 16.95 ea.
- N-142 All BB w/ SHP 26.95 ea.
- N-234 1967-69 SB 3/4" Tall 14.99 ea.



CHO-3200

Oil Pressure Lines

Correct black plastic line with fittings for most cars with mechanical gauges.

- CHO-3200 Most w/ Gauges 9.99 ea.



NPZ-134

Oil Pressure Line Kit

Correct oil pressure line for console gauges.

- NPZ-134 1967-69 w/ Gauges 29.95 kit



ALG-456

Oil Line Grommet

Correct firewall grommet for oil line.

- ALG-456 1967-69 All 10.95 ea.



AP-2044

Oil Line Bracket

Correct bracket for retaining line to engine.

- AP-2044 1967-69 All 11.95 ea.



KN-HP2002

KN-PS2002



K&N Oil Filters

K&N Performance Oil Filters have been specially designed for professional installers and service providers. Their high flow design can help to improve engine performance by reducing oil filter restriction. Performance Gold Oil Filters have a Premium Wrench-Off design. Oil Filters have become a favorite among consumers for its durability and easy removal. Our Performance Silver Oil Filters have a fluted canister shape so they can be removed with a traditional oil filter wrench commonly available to commercial installers. These Performance oil filters provide outstanding filtration and engine protection throughout their service life. They are engineered to handle all grades of synthetic, conventional and blended motor oils. The pleated media provides high capacity making them suitable for extended oil change intervals when used in accordance with the vehicle and motor oil manufacturers recommendation.

- KN-HP2002 1967-92 Gold Wrench Off 11.99 ea.
- KN-PS2002 1967-92 Silver Standard Fluted 8.99 ea.

No Volume Discount.

STARTERS & RELATED

NO CORE CHARGE



ASM-10A

Starter Motor

We carry original AC Delco USA remanufactured starter motors complete with warranty. No core charge.

ASM-10A	1967-81 SB Auto	113.99 ea.
ASM-10M	1967-81 SB Manual	113.95 ea.
ASM-20A	1967-81 BB Auto	102.95 ea.
ASM-20M	1967-81 BB Manual	102.99 ea.

No Volume Discount. No Core Charge.



TUF-3193NB



TUF-3510A

Tuff Stuff Gear Reduction Starters

These gear reduction starters will allow you to easily crank over your high performance engine. They use less draw than traditional replacement starters and gear reduction allows them to crank over engines with higher compression. These starters will work on both Small Block Chevy and Big Block Chevy Engines using 153 or 168 tooth flywheels. Please be sure to check your flywheel tooth count before ordering.

TUF-6550B	1.6 H.P., 11:1 Compression White Zinc	143.99 ea.
TUF-6550A	1.6 H.P., 11:1 Compression Chrome	183.99 ea.
TUF-6584B	1.9 H.P., 12:1 Compression Black	139.99 ea.
TUF-6772B	2.6 H.P., 18:1 Compression Black	177.99 ea.
TUF-3193NB	3 H.P., 18:1 Compression White Zinc	175.99 ea.
TUF-3510A	1.9 H.P., 18:1 Compression Chrome*	167.99 ea.
TUF-3510B	1.9 H.P., 18:1 Compression Black*	124.99 ea.

*Offset mounting bolts, 168 tooth flywheel only.



TUF-7629



Tuff Stuff Hot Start Remote Solenoid Kit

Give your starter an extra 12 V boost with these hot start kits from Tuff Stuff! This kit is designed to eliminate hot start problems that are common with starter-mounted solenoids. Ideal for GM full-size OEM starters.

TUF-7629	1964-77 All	23.99 kit
----------	-------------------	-----------

No volume discount.



BV-2070



BV-2072



BV-2074

Starter Motor Bolts OEM

Correct "Knurled" bolts for attaching starter motor to block.

BV-2070	SB 3/8-16 x 1 7/8" (Short)	5.99 ea.
BV-2072	BB 3/8-16 x 3 5/8" (Long)	4.99 ea.
BV-2074	3/8-16 x 4 11/16" (X-Long)	5.99 ea.



ATE-4353

Starter Motor Brace

Correct brace for attaching starter to block.

ATE-4353	1967-72 SB w/o 350	11.95 ea.
ATW-2516	1967-72 SB 350	8.95 ea.
ABB-9655	1967-72 All BB	12.99 ea.
APO-516	Attaching Screw	0.50 ea.



APX-1443

Starter Heat Shield

Correct starter heat shield for big block.

APX-1443	All BB	34.95 ea.
GCS-S6077	Satin	14.39 ea.



ALI-1504



A-193

Starter Solenoid Wire Clip

Correct clip for retaining wire harness to solenoid.

ALI-1504	1967 All V8	17.99 ea.
A-193	1968+ All	24.95 ea.

WATER PUMPS & PULLEYS

NO CORE CHARGE



ABR-0898

AC Delco Water Pumps

Brand new AC Delco water pumps.

ABR-0898	1967-68 SB (Short Style)	63.95 ea.
ABR-0918	1967-68 BB (Short Style)	119.99 ea.
ABR-1109	1969-81 SB (Long Style)	65.95 ea.
ABR-1002	1969-72 BB (Long Style)	89.99 ea.

No Core Charge.



TUF-1461N



TUF-1461N



Tuff Stuff Water Pumps

Tuff Stuff water pumps are available in multiple different finishes. Available in standard flow or high flow (Super Cool) version for high power applications. Also available in "Smoothie" version, which features flat top casting with no top water port or plug.

SS= Short Style LS = Long Style

Small Block

TUF-1354NA	1964-71 SS, Chrome	109.99 ea.
TUF-1354N	1964-71 SS, SC, Cast Finish	76.99 ea.
TUF-1354NC	1964-71 SS, SC, Black	88.99 ea.
TUF-1354NB	1964-71 SS, SC, Chrome	117.99 ea.
TUF-1461N	1964-71 SS, Smoothie, Chrome	93.99 ea.
TUF-1449NA	1969+ SS, Chrome	139.99 ea.
TUF-1511NC	1969+ LS, Platinum, Cast Finish	158.99 ea.
TUF-1449N	1969+ LS, SC, Cast Finish	76.99 ea.
TUF-1449NC	1969+ LS, SC, Black	88.99 ea.
TUF-1449NB	1969+ LS, SC, Chrome	156.99 ea.
TUF-1448NC	1969+ LS, SC, Smoothie, Cast Finish	121.99 ea.
TUF-1448NB	1969+ LS, SC, Smoothie, Polished Aluminium	156.99 ea.

Big Block

TUF-1494N	1964-72 SS, Cast Finish	82.99 ea.
TUF-1494NC	1964-72 SS, SC, Black	105.99 ea.
TUF-1494NA	1964-72 SS, SC, Chrome	139.99 ea.
TUF-1461NA	1969+ LS, Chrome	164.99 ea.
TUF-1461N	1969+ LS, SC, Cast Finish	93.99 ea.
TUF-1461NC	1969+ LS, SC, Black	112.99 ea.



Heater Hose / Bypass Nipples

OE style reproduction zinc plated fitting.

AWN-058	5/8" Short	7.95 ea.
AWN-034	3/4" Short	7.95 ea.
AWN-134	3/4" Long w/ AC	8.95 ea.
APN-1060	3/4" Bypass Slotted	7.95 ea.
AWN-1059	1964-67 SB SHP 90°	22.95 ea.

THIS IS AN EXCLUSIVE GROUND UP PRODUCT

Water Pump Bypass Hose Kits
Correct OEM GM marked bypass hose with correct clamps.

CPH-1637	1967-68 Z/28	12.95 kit
CPH-1658	1967-68 BB (Molded)	12.95 kit
CPH-1672	1969-72 BB (Ribbed)	9.95 kit
CPB-034	1967 BB Clamp	4.95 ea.



Water Pump OEM Attaching Bolt Kits

Correct style attaching bolts with "TR" head markings.

ATR-3232	1967-68 3 Bolts 1 Stud	8.99 kit
ATR-4334	1969-72 All 4 Bolts M Mark	10.99 kit
AWS-301S	Stud Only (Short)	2.99 ea.
AWS-302L	Stud Only (Long)	3.95 ea.



Tuff Stuff Water Pump Bolt Kits

Chrome plated hex head bolts. Includes 4 bolts, 4 flat washers and 4 lock washers.

TUF-7675A	All SB, Short Style	18.99 ea.
TUF-7676A	All BB, Short Style	18.99 ea.
TUF-7678A	All, Long Style	18.99 ea.

Short Water Pump Washer

This washer is for any Chevrolet engine with a short water pump. Since this part can't be seen when the pulley is installed, most people are unaware it exists, but it provides important support for the pulley.



AWW-65	1967-68 All	4.99 ea.
--------	-------------------	----------

**Works on all cars with short water pump.*



Water Pump Pulley

OE style reproduction of original water pump pulleys.

AWP-0245	1967-68 7" 2 Groove Deep	119.95 ea.
AWP-796	1969-81 SB 1 Groove Deep	29.95 ea.
AWP-240	1969-81 SB 1 Groove Deep Z/28	79.99 ea.
AWP-9950	1967-68 All BB 1 Groove Deep	42.95 ea.
AWP-656	1967-68 BB 2 Groove Deep	99.95 ea.
AWP-1394	1969-81 BB 1 Groove Deep	47.99 ea.
AWP-949	1969-81 All 2 Groove Deep w/ AC	99.99 ea.



Billet Water Pump Pulleys

These show quality billet aluminum water pump pulleys will set your show car apart from the crowd. Made of high quality aircraft aluminum.

GCS-S9478	SB, SWP, 1 Groove, Satin	38.99 ea.
GCS-S9478POL	SB, SWP, 1 Groove, Polished	41.99 ea.
GCS-S9600	SB, SWP, 1 Groove, Chrome	16.79 ea.
GCS-S9479	SB, SWP, 2 Groove, Satin	52.99 ea.
GCS-S9479POL	SB, SWP, 2 Groove, Polished	52.99 ea.
GCS-S9601	SB, SWP, 2 Groove, Chrome	16.79 ea.
GCS-S9482	SB, LWP, 1 Groove, Satin	28.79 ea.
GCS-S9482POL	SB, LWP, 1 Groove, Polished	33.59 ea.
GCS-S9604	SB, LWP, 1 Groove, Chrome	16.79 ea.
GCS-S9483	SB, LWP, 2 Groove, Satin	52.99 ea.
GCS-S9483POL	SB, LWP, 2 Groove, Polished	62.99 ea.
GCS-S9605	SB, LWP, 2 Groove, Chrome	16.79 ea.
GCS-S8840	BB, SWP, 1 Groove, Satin	33.59 ea.
GCS-S8840POL	BB, SWP, 1 Groove, Polished	33.59 ea.
GCS-S8842	BB, SWP, 2 Groove, Satin	52.99 ea.
GCS-S8842POL	BB, SWP, 2 Groove, Polished	46.39 ea.
GCS-S9815	BB, SWP, 2 Groove, Chrome	25.59 ea.
GCS-S8844	BB, LWP, 2 Groove, Satin	42.39 ea.
GCS-S8844POL	BB, LWP, 2 Groove, Polished	37.79 ea.
GCS-S9723	BB, LWP, 2 Groove, Chrome	20.79 ea.

Note: SWP = Short Water Pump. LWP = Long Water Pump.

Hardware
GCS-S0005 Bolts



Crank Pulleys

All pulleys are original GM or the highest quality reproductions on the market. Each pulley is finished in factory semi gloss black like the originals.

ACP-904	1967-68 327/350 1 Groove	39.95 ea.
ACP-833	1967-68 2 Groove Deep	52.95 ea.
ACP-414	1969-81 SB 3 Groove	69.99 ea.
NQ-457	1969-81 350 2 Groove Deep Z/28	79.99 ea.
ACP-203	1964-68 396 1 Groove*	45.95 ea.
ACP-108	1967-68 396/375 2 Groove Deep**	55.95 ea.
ACP-333	1967-68 396/375 3 Groove Deep Cast	199.95 ea.
ACP-404	1969-79 SB 2 Groove	69.95 ea.
AHQ-1396	1969-81 396 2 Groove Deep	89.99 ea.
ACP-330	1969-81 396/454 3 Groove w/ AC	74.95 ea.

**without Power Steering **for all with power steering use with ADP-61*



GCS-S8845POL

GCS-S9480

Billet Crank Pulleys

These show quality billet aluminum crank pulleys will set your show car apart from the crowd. Made of high quality aircraft aluminum.

GCS-S9480	SB, SWP, 1 Groove, Satin.....	31.99 ea.
GCS-S9480POL	SB, SWP, 1 Groove, Polished.....	41.99 ea.
GCS-S9602	SB, SWP, 1 Groove, Chrome.....	18.39 ea.
GCS-S9481	SB, SWP, 2 Groove, Satin.....	41.99 ea.
GCS-S9481POL	SB, SWP, 2 Groove, Polished.....	33.59 ea.
GCS-S9603	SB, SWP, 2 Groove, Chrome.....	16.79 ea.
GCS-S8858	SB, SWP, 3 Groove, Satin.....	57.99 ea.
GCS-S8858POL	SB, SWP, 3 Groove, Polished.....	52.99 ea.
GCS-S8963	SB, SWP, 3 Groove, Chrome.....	31.19 ea.
GCS-S9484	SB, LWP, 1 Groove, Satin.....	52.99 ea.
GCS-S9484POL	SB, LWP, 1 Groove, Polished.....	42.39 ea.
GCS-S9606	SB, LWP, 1 Groove, Chrome.....	29.59 ea.
GCS-S9485	SB, LWP, 2 Groove, Satin.....	33.59 ea.
GCS-S9485POL	SB, LWP, 2 Groove, Polished.....	42.39 ea.
GCS-S9607	SB, LWP, 2 Groove, Chrome.....	29.59 ea.
GCS-S9486	SB, LWP, 3 Groove, Satin.....	52.99 ea.
GCS-S9486POL	SB, LWP, 3 Groove, Polished.....	55.99 ea.
GCS-S9608	SB, LWP, 3 Groove, Chrome.....	32.79 ea.
GCS-S8841	BB, SWP, 1 Groove, Satin.....	27.99 ea.
GCS-S8841POL	BB, SWP, 1 Groove, Polished.....	41.99 ea.
GCS-S9817	BB, SWP, 1 Groove, Chrome.....	23.19 ea.
GCS-S8843	BB, SWP, 2 Groove, Satin.....	33.59 ea.
GCS-S8843POL	BB, SWP, 2 Groove, Polished.....	42.39 ea.
GCS-S9816	BB, SWP, 2 Groove, Chrome.....	24.79 ea.
GCS-S8849	BB, SWP, 3 Groove, Satin.....	57.99 ea.
GCS-S8849POL	BB, SWP, 3 Groove, Polished.....	57.99 ea.
GCS-S8845	BB, LWP, 3 Groove, Satin.....	73.99 ea.
GCS-S8845POL	BB, LWP, 3 Groove, Polished.....	73.99 ea.
GCS-S9724	BB, LWP, 3 Groove, Chrome.....	29.59 ea.

Note: SWP = Short Water Pump. LWP = Long Water Pump.



BFC-333

Crank Pulley Bolt OEM

Attaching bolt kit.

BFC-333	All w/ Fine Thread.....	6.95 kit
BRB-100	All w/ Coarse Thread.....	6.95 kit



BPB-5934

Harmonic Balancer Attaching Bolt-Washer

BPB-5933	1964-72 Most SB.....	14.99 kit
BPB-5934	1965-72 All BB.....	13.99 kit

POWER STEERING



Concourse Series "Banjo" Style Power Steering Pumps

These are brand new banjo style power steering pumps with correct reservoir and inlet and outlet fittings. No core charge!

APS-6086	1967-68 All V8.....	175.95 ea.
APS-6153	1969 SB.....	179.95 ea.
APS-6151	1969 BB.....	179.95 ea.
APS-6165	1970-72 All V8*.....	179.95 ea.

*Use with 1970 hose & brackets. No Volume Discounts.



NO CORE CHARGE

APS-6000R

Power Steering Pumps - Replacement

Completely rebuilt second design power steering pumps. These pumps will differ in appearance from our originals, but will fit and function the same. No core charge!

APS-6000R	1969-72 All.....	99.95 ea.
-----------	------------------	-----------

No volume discount



TUF-6183B



TUF-6195A

Tuff Stuff Power Steering Pumps

GM Saginaw style pumps feature all new components: reservoir, pump assembly, cap & dipstick and hardware when it applies. Rated at 1200 psi, rated to work with most gearbox systems.

TUF-6197A	1967-68 SB Chrome Banjo Style.....	235.99 ea.
TUF-6197B	1967-68 SB Black Banjo Style.....	186.99 ea.
TUF-6195A	1969 BB Chrome Banjo Style.....	235.99 ea.
TUF-6195B	1969 BB Black Banjo Style.....	186.99 ea.
TUF-6193A	1970 All Chrome Banjo Style.....	235.99 ea.
TUF-6193B	1970 All Black Banjo Style.....	186.99 ea.
TUF-6183A	1970-74 All Chrome.....	221.99 ea.
TUF-6183B	1970-74 All Black.....	174.99 ea.
TUF-6182A	1975-78 All Chrome.....	221.99 ea.
TUF-6182B	1975-78 All Black.....	174.99 ea.
TUF-6181A	1979 All Chrome.....	221.99 ea.
TUF-6181B	1979 All Black.....	174.99 ea.
TUF-6180A	1980-81 All Chrome.....	221.99 ea.
TUF-6180B	1980-81 All Black.....	174.99 ea.
TUF-6179A	1982-87 All Chrome.....	221.99 ea.
TUF-6179B	1982-87 All Black.....	174.99 ea.
TUF-6184A	1988-92 All Chrome.....	221.99 ea.
TUF-6184B	1988-92 All Black.....	174.99 ea.

No volume discount.



ADR-077



APC-42

Power Steering Pump Cap

Quality replacement power steering pump cap.

ADR-077	1967-81 All Plastic.....	8.95 ea.
APC-42	All OE Style Metal.....	19.95 ea.



GCS-S8848

GCS-S8948

Billet Power Steering Pulleys

These show quality billet power steering pulleys will set your show car apart from the crowd. Made of high quality aircraft aluminum.

GCS-S8848	1 Groove, Satin.....	29.59 ea.
GCS-S8848POL	1 Groove, Polished.....	35.69 ea.
GCS-S8948	1 Groove, Chrome.....	19.99 ea.
GCS-S8847	2 Groove, Satin.....	41.99 ea.
GCS-S8847POL	2 Groove, Polished.....	38.39 ea.
GCS-S8947	2 Groove, Chrome.....	27.19 ea.



ASP-509

Power Steering Pump Pulleys

OE style reproduction power steering pulleys.

ASP-3847	1967-69 1 Groove Deep Cast 302, 396/375, 427.....	155.95 ea.
ASP-509	1967-81 1 Groove.....	36.95 ea.
ASP-107	1969-81 2 Groove w/ AC.....	44.99 ea.
ASP-1395	1969-81 1 Groove SHP.....	49.99 ea.
23-28	Pulley Nut.....	3.95 ea.

BUY'N SAVE
WITH KITS



PSKIT-69FBB

Power Steering Conversion Kit

Are you tired of getting a workout every time you want to turn? Ground Up makes it easy to convert to power steering with this power steering conversion kit! We have taken all of the guesswork out of selecting the parts to convert with this all in one solution! Includes: OEM Banjo Style Power Steering Pump, Pump Cap, Brackets, Hardware, Pulley, Pulley Nut, Pressure Hose and Return Hose.

PSKIT-69FSB	1969 SB w/o AC.....	314.06 kit
PSKIT-69FSBAC	1969 SB w/ AC.....	320.50 kit
PSKIT-69FBB	1969 BB w/o AC.....	282.87 kit
PSKIT-69FBBAC	1969 BB w/ AC.....	289.30 kit
PSKIT-702FSB	1970-72 SB w/o AC.....	304.47 kit
PSKIT-702FSBAC	1970-72 SB w/ AC.....	310.90 kit
PSKIT-702FBB	1970-72 BB w/o AC.....	273.28 kit
PSKIT-702FBBAC	1970-72 BB w/ AC.....	279.71 kit



ADP-61

1967-68 396 Driver Pulley

OE style reproduction of the SS396 only power steering driver pulley.

ADP-61	1967-68 BB Driver.....	44.95 ea.
--------	------------------------	-----------



ARK-678F

BUY'N SAVE
WITH KITS

Power Steering Hose Kits

This kit comes with OEM high pressure hose, low pressure return tube, hose and correct clamps

ARK-678F	1967-68 All V8.....	38.17 kit
ARK-69F	1969 All V8.....	39.96 kit
ARK-70F	1970-72 V8.....	39.96 kit

No Volume Discount

Power Steering OEM High Pressure Hose

New correctly bent OEM high pressure hoses with correct fittings.



OEM



CPX-6616

CPX-6616	1967-68 All V8.....	26.95 ea.
----------	---------------------	-----------



CPX-6602

CPX-6602	1969 All V8.....	26.95 ea.
----------	------------------	-----------



CPX-6618

CPX-6618	1970-72 BB.....	26.95 ea.
----------	-----------------	-----------



CPX-277

CPX-263	1970-1972 SB.....	26.95 ea.
---------	-------------------	-----------

CPX-277	1977-79 All V8.....	26.95 ea.
---------	---------------------	-----------

CPX-634	1980-81 All V8 w/ O Rings.....	26.95 ea.
---------	--------------------------------	-----------



NPX-16

Power Steering Return Hose

Complete with correct pre bent flared tube, OEM hose and correct clamps.

NPX-16	1967-76 All V8.....	17.95 kit
CPS-038	OEM Return Hose.....	2.95 per ft
CPN-512	OEM Clamps Screw Type.....	1.95 ea.



ASC-128



AB-31F

Power Steering Hose Retainers

Correct clip for retaining hose to steering box and chassis.

ASC-128	All V8 On Steering Box.....	12.95 ea.
---------	-----------------------------	-----------

AB-31F	1967-69 All V8 On Frame.....	20.95 ea.
--------	------------------------------	-----------

Power Steering Brackets

Original style reproduction and original GM brackets



ASB-7KIT

Big Block Power Steering Bracket Kit

Complete kit with cradle, adjustment brackets and hardware.

ASB-7KIT	1969-81 All BB.....	63.77 kit
----------	---------------------	-----------

Will work on most BB engines with long style pump.
May need some modification.



ASB-9KIT

1969-72 Small Block Power Steering Bracket Kit

Complete kit with all three brackets.

ASB-9KIT	1969-72 SB.....	88.07 kit
----------	-----------------	-----------

Will work on most SB engines with long style pump.
May need some modification.

BUY'N SAVE
WITH KITS



ASB-366

ASB-366	1967-68 SB Cradle.....	49.95 ea.
---------	------------------------	-----------

For use with short water pump.



ASB-383

ASB-383	1967-68 Z/28 / SS350.....	39.95 kit
---------	---------------------------	-----------

For use with short water pump.



ASB-184

ASB-184	1967-68 SS396 Cradle.....	64.99 ea.
---------	---------------------------	-----------

For use with short water pump.



ASB-186

ASB-186 1967-68 396 Adjuster..... 39.99 ea.
For use with short water pump.



AQW-1418

AQW-1418 1969 All BB (3 piece).....64.99 kit
Works with original long water pump & P/S pump..



ASB-3941

ASB-3941 1969-76 All SB Cradle..... 25.95 ea.
For use with long water pump.



ASB-874

ASB-874 1969-72 SB Rear Support..... 35.95 ea.
For use with long water pump.



AAB-2610

AAB-2610 1969-76 SB Adjuster..... 35.95 ea.
For use with long water pump.



ASB-422

ASB-422 1970-72 All BB Cradle 32.95 ea.
For use with long water pump.



ASB-931

ASB-931 1970-81 All BB Adjuster..... 24.95 ea.
For use with long water pump.



BSB-1970

Power Steering Hardware Kits

Our kits feature all correct hardware to attach power steering brackets to engine. A MUST!

G-4804	1967 SB 302,350 15.99 kit
G-4805	1967 BB 396 15.99 kit
G-4917	1968 SB 302,350 15.99 kit
G-4918	1968 BB 396 15.99 kit
BSB-69SB	1969-74 SB All 11.99 kit
BSB-1969	1969 All BB 17.99 kit
BSB-1970	1970+ All BB 12.95 kit

BUY'N SAVE WITH KITS



GBK-1A

Power Steering Gearbox Kits

Now you can add one of these awesome "close ratio" gear boxes to your conversion. These boxes are original remanufactured GM units and will add the ultimate handling to your ride. Our kit comes with steering box, GM steering coupler (rag joint) and correct attaching bolts. Choose from fast ratio or super fast ratio! No core charge!

1967-69 Camaro

GBK-1F	3 - 3.5 Fast 290.49 kit
GBK-1SFF	2.5 Super Fast 316.03 kit

1970-76 Camaro

GBK-1A	3 - 3.5 Fast 298.24 kit
GBK-1SFA	2.5 Super Fast 323.78 kit

No volume discount. Ships UPS Oversize.



BSB-759

Steering Box Bolt

Complete with correct thick washer and bolt.

BSB-757	1967-69 All 3.95 ea.
BSB-759	1970-76 All 6.99 ea.



D-1870



BX-64K

Pitman Arm

Manual Steering

DA-985	1967-69 75.95 ea.
DA-138Z	1967-69 Z/28 Fast Ratio 169.95 ea.
DA-811	1970-81 89.95 ea.

Power Steering

D-1870	1967-69 69.95 ea.
DA-711	1970-81 109.99 ea.

Pitman Arm Nut

BX-64K	1967-81 6.95 ea.
--------	---------	----------------

ATE-8869A

ATE-8871



ATJ-411



Steering Coupler

Complete joint for connecting column to box. 1967-69 with manual steering features fine spline and 1970-76 with manual steering features coarse spline.

ATE-8869A	1967-69 Manual 49.95 ea.
ATE-8869B	1970-76 Manual 49.95 ea.
ATE-8871	1967-76 Power 49.95 ea.
ATJ-411	1967-76 Bolt All 5.99 ea.

IIS-70F

IIS-78

IIS-78S



Intermediate Steering Shaft

Restore proper steering stability and safety with this newly remanufactured intermediate steering shaft. This shaft goes from the steering column down to the steering box and wears out over time, causing sloppy steering feel.

IIS-70F	1970-76 All 205.95 ea.
IIS-78	1978-92 All w/o Shroud 119.95 ea.
IIS-78S	1978-92 All w/ Shroud 139.95 ea.

NO CORE CHARGE

ARC-12SF



Manual Steering Boxes

Complete remanufactured original Saginaw assemblies. Choose from standard or quick ratio. No core charge.

ARC-12A	1967-69 24:1 Std 289.95 ea.
ARC-12B	1970-76 24:1 Std 289.95 ea.
ARC-12SF	1967-76 16:1 Quick 309.95 ea.

Note: Use ATE-8869B coupler with ARC-12SF.
No volume discount. Ships UPS Oversize.

FPC67ZZSS



THE RIGHT Stuff

Fuel Pump to Carburetor Lines

Correct reproductions of the original fuel lines that run from the fuel pump to the carburetor. Each is CNC bent using original factory blueprints. All lines are available in original steel material (OM) or state of the art show quality stainless steel (SS). All lines are made right here in the USA.

		OM	SS
FPC6702	1967 327/210 2bbl Pre-April.....	19.99 ea.....	25.99 ea.
FPC6703	1967 After April, 1968 All 327/210.....	19.99 ea.....	25.99 ea.
FPC6705	1967-69 350/295, 327/210 5/16".....	19.99 ea.....	25.99 ea.
FPC67ZZ	1967-68 Z/28 4 pc.....	51.99 ea.....	61.99 ea.
FPC6707	1967-69 327/275, 350/295 3/8".....	19.99 ea.....	25.99 ea.
FPC6709	1967-68 396/325.....	19.99 ea.....	25.99 ea.
FPC6901	1969 350 2bbl 5/16".....	19.99 ea.....	25.99 ea.
FPC6902	1969 307, 327 2bbl 5/16".....	19.99 ea.....	25.99 ea.
FPC69XR	1969 Cross Ram, No Block, 3 pc.....	51.99 ea.....	61.99 ea.
FPC69ZZ	1969-72 Z/28 w/ Dual Feed Holley.....	51.99 ea.....	61.99 ea.
FPC7001	1970-72 350/300.....	19.99 ea.....	25.99 ea.
FPC7005	1970 BB Q-Jet.....	19.99 ea.....	25.99 ea.
FPC7203	1971-72 BB Q-Jet.....	36.99 ea.....	50.99 ea.
FPC72ZZ	1972-74 350 4bbl Z/28 Q-Jet.....	21.99 ea.....	27.99 ea.
FPC7801	1978-80 V8 2bbl.....	21.99 ea.....	27.99 ea.
FPC7802	1978-80 V8 4bbl.....	19.99 ea.....	27.99 ea.
FPC8001	1979-81 350 w/ Q-Jet.....	21.99 ea.....	27.99 ea.

Add "SS" to end of part number when ordering stainless.

CPC7007-38

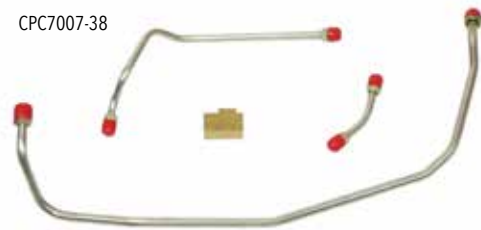

THE RIGHT Stuff

Holley Pump to Carb Lines - New

This fuel pump to carburetor line for use with a new Holley carburetor. OEM carburetors used 5/16 inch inlet nuts, but newer carburetors use 3/8 inch inlet nuts. These lines will improve fuel flow and are designed to be used with these new carburetors.

		OM	SS
APC858	1967-68 BB 8-5/8" Spread.....	48.99 ea.....	58.99 ea.
BPC858	1969 BB 8-5/8" Spread.....	48.99 ea.....	58.99 ea.
BPC938	1969 BB 9-3/8" Spread.....	48.99 ea.....	58.99 ea.
CPC7006-38	1970 BB Short # 747 Pump.....	60.95 ea.....	63.95 ea.
CPC7007-38	1970 BB Long # 768 Pump.....	60.95 ea.....	77.95 ea.
DPC858	1969-72 SB 8-5/8" Spread.....	51.99 ea.....	61.99 ea.
DPC938	1969-72 SB 9-3/8" Spread.....	51.99 ea.....	61.99 ea.

Note: 1970 5/16" lines w/ 3/8" at carb. Add "SS" to end of part number when ordering stainless.

Holley Pump to Carb Lines - Original

Correct reproductions of the original Holley fuel pump to carb lines complete with lines and fuel blocks. These lines are for factory Holleys with 5/16" inlet nuts. These lines will only work on stock engines.

		OM	SS
FPC6775	1967-68 396/375 HP.....	49.99 ea.....	59.99 ea.
FPC6975	1969 396/375 HP.....	49.99 ea.....	59.99 ea.
PCY03	5/16" inlets, 9 3/8" center to center.....	36.99 ea.....	41.99 ea.

Add "SS" to end of part number when ordering stainless.

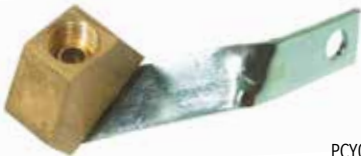

PCY02

Fuel Pump to Carburetor Parts

Correct Y blocks and T blocks for your dual feed Holley carburetor.

PCY01	Y Block w/o Bracket, Brass.....	19.99 ea.
PCY02	Y Block w/ Bracket, Brass.....	28.99 ea.
BPS-7432	Stud for PCY02.....	3.95 ea.
RSBB06	Y Block w/ 3/8" Ports, Used for PCY05.....	24.99 ea.



AHL-516

AHL-38

Carburetor Inlet Fittings

Correct inlet nuts with washers for stock carbs.

AHL-516	5/16".....	12.99 ea.
AHL-38	3/8".....	12.99 ea.



INL-CCF201

Fuel Line Clip Kits

These convenient kits include all of the correct clips needed to install a set of factory fuel lines.

INL-CCF201	1967-68 7pc.....	22.95 kit
INL-CCF202	1969 w/o Return 7pc.....	20.95 kit
INL-CCF203	1969 w/ Return 7pc.....	26.95 kit
INL-CCF205	1970-71 3/8" w/o Return 10pc.....	26.95 kit
INL-CCF206	1970-71 3/8" w/ Return 10pc.....	36.95 kit
INL-CCF207	1972-77 3/8" w/o Return 10pc.....	28.95 kit
INL-CCF208	1972-77 3/8" w/ Return 10pc.....	36.95 kit
INL-CCF209	1978-81 3/8" w/ Return 10pc.....	36.95 kit



AFR-162

1967-68 396 Fuel Line Retainer

Correct fuel line retainer which mounts to the passenger side frame mount on all big blocks.

AFR-162	1967-68 BB.....	10.95 ea.
---------	-----------------	-----------



AFB-239

Z/28 Fuel Line Brace

Correct factory installed brace for carburetor line.

AFB-239	1969-71 Z/28.....	26.99 ea.
---------	-------------------	-----------

AJE-395



ACE-486

ACE-9599

Fuel Pump Hardware

AJE-395	All Activating Rod.....	14.95 ea.
ACE-9599	All SB Plate.....	10.99 ea.
ACE-4867	Fuel Pump Bolts.....	7.95 kit

GCS-S2057



Fuel Pump Block Off Plates

Necessary when using an electric fuel pump.

GCS-S2057	SB, Chrome.....	5.59 ea.
GCS-S2058	BB, Chrome.....	5.59 ea.

ACDelco



AFP-1021

Fuel Pump

Original correct replacement fuel pumps. Brand new AC-Delco units "gold anodized" as original.

AFP-1116	1967-68 327, 350 5/16"	69.95 ea.
AFP-1021	1968-81 All SB 3/8"	41.95 ea.
AFP-1121	1967-81 All BB 3/8"	44.99 ea.
AFP-1124	1968-81 All BB w/ Return	51.95 ea.



AFP-40727

AC Delco Logo Fuel Pump

NOS fuel pump which features the large AC Delco logo. This fuel pump is a must when restoring your car to factory stock.

AFP-40727	1967-72 GM #40727	65.95 ea.
AFP-40503	1967-72 GM #40503	65.95 ea.
AFP-40963	1970-72 GM #40963	65.95 ea.

Note: AFP-40963 has return.



GCS-S2302

Chrome Fuel Pump

Show quality chrome plated fuel pump for all small block. Matching chrome mounting plate with gasket sold separately.

GCS-S2302	SB, Pump	59.99 ea.
GCS-S2310	SB, Plate	6.39 kit

QF-30-350QFT



Quick Fuel Technology Fuel Pumps

For the street cruiser, it's tough to beat the simplicity and reliability of a mechanical fuel pump. Quick Fuel Technology's mechanical pumps flow 110 gallons per hour and utilize lightweight aluminum housings. They feature integrated shutoff valves that are preset at 6.5- to 8 psi, eliminating the need for a separate pressure regulator. For added installation flexibility, the pump casting can be rotated to accommodate various plumbing configurations. 3/8" NPT threads. Gasoline only.

QF-30-350QFT	Small Block	99.99 ea.
QF-30-454QFT	Big Block	107.99 ea.

No volume discount.

Quick Fuel Technology Electric Fuel Pumps

QFT's electric fuel pumps are perfect for combinations that are neither stock nor all out race cars. These pumps flow more than enough fuel to support between 400-750 hp. Mounting hardware and brackets are included.

- 125 GPH Flow Rate
- 14 PSI Maximum Pressure
- Features 3/8" NPT Inlets and Outlets
- Draws 4 Amps or Less at Full Load
- For Carbureted Gasoline Applications Only



QF-30-125-1QFT

QF-30-125-1QFT	Pump Only	114.99 ea.
QF-30-125-1RQFT	Pump/Regulator	131.99 ea.

No volume discount.



ASB-9KIT

1969 Camaro 350 & 396 3 Piece Line Sets

These unique lines are for use with cars equipped with the GF-432 canister filter and bracket.

		OM	SS
FPC6905	1969 350	36.99 ea.	46.99 ea.
FPC6903	1969 396/325	36.99 ea.	46.99 ea.
FPC6903	1969 396/350	36.99 ea.	36.99 ea.



AXP-3800

Fuel Pump Hose Kit

Correct GM hose for connecting fuel pump to main fuel line. Complete with correct "colored" pinch clamps.

AXP-3800	All 3/8" 3pc	4.95 kit
AXP-1438	All 3/8"-1/4" 6pc	6.95 kit
AXP-6400	All 3/8" 90 Degree Bend 3pc	11.95 kit



ASB-7KIT

GF-432 Fuel Filter & Bracket

This is an OE style reproduction of the original GF-432 fuel filter & bracket for use with 3 piece fuel line. Buy the kit and save!

GF-432K	1969 GF-432 Complete	50.31 kit
AAC-432	1969 GF-432 Filter	39.95 ea.
AFB-234	1969 GF-432 Bracket	15.95 ea.

Holley

Holley Chrome Fuel Pumps

Mechanical pumps designed to work with stock or mildly modified engines.

Free-flow output of 80 GPH (SB) or 80-130 GPH (BB). Body castings can be rotated 360-degrees to ease mounting in difficult places. Heavy duty construction can withstand long periods at high RPM. 1/4" (SB) 3/8" (BB) pipe thread inlet and outlet ports.

HOL-12834	Small Block	91.99 ea.
HOL-12835	Big Block	91.99 ea.

Note: Not compatible with methanol or alcohol. Cannot be used with fuel injection systems.

Holley Electric Fuel Pumps

Holley is proud to introduce the all new Holley Mighty Mite™ electric fuel pumps! They're big on performance, but small in size! They're quiet, easy to install and work with gas, diesel, blended alcohol and E85!

12 volt operation, .25 gal/hr flow, Good for up to 300HP naturally aspirated, Simple 2 wire hookup, Self-priming and regulating.

Quiet operation - 65db, Hose barsbs Fit 5/16" Fuel Hose, Made in the USA

HOL-12-426	All 25 GPH 1.5-4 PSI	49.99 ea.
HOL-12-427	All 32 GPH 4-7 PSI	49.99 ea.

No volume discount.

Holley Fuel Pressure Regulator

Holley fuel pressure regulators are designed to precisely control the fuel pressure from the fuel pump to the carburetor. Too much fuel pressure for a given needle and seat assembly will overload and may cause flooding or drivability problems. Each Holley fuel pressure regulator is fully adjustable so regulating the fuel pressure to your engines needs is simple.

12 volt operation. Preset to 7psi. 3/8" NPT ports (1 in, 1 out, 1 bypass or return). Used in systems with a return line back to the fuel tank

HOL-12-803BP	All Carbureted	87.99 ea.
--------------	----------------------	-----------

No volume discount.

HOL-12-803BP



HOL-12-426



HOL-12834



AAC-427



AAC-455

Fuel Filters

Original GM AC Delco

AAC-427	Q-Jet Short Style	4.95 ea.
AAC-455	All Holley Brass	5.99 ea.



GCS-S4297

GCS-S9245

GCS-S9407

GCS-S9177

Chrome Inline Fuel Filters

Choose from a variety of show quality chrome fuel filters to dress up your engine.

Carburetor

GCS-S9407	Bronze Element, 3/8"	8.79 ea.
GCS-S9177	Paper Element, 3/8"	6.39 ea.
GCS-S9245	Glass Element, 3/8"	9.34 ea.

Red Top High Capacity Chrome Fuel Filters

Show quality chrome plated fuel filter with paper element and pipe fittings.

GCS-S4297	Small	33.99 ea.
GCS-S4295	Large	33.99 ea.

NO CORE CHARGE

AIT-6961



Alternators

Professionally rebuilt alternator which is proudly made in the USA. Each alternator is 100% tested and rebuilt to exceed OEM specifications.

- AIT-6961 41 Amp External Reg 79.95 ea.
- AIT-6963 55 Amp External Reg 89.95 ea.
- AIT-3342 63 Amp Internal Reg 84.99 ea.

No Volume Discount

TUF-7127D



Tuff Stuff Internally Regulated Alternators

Designed to handle the demand for power needed for today's electronics, Tuff Stuff's high powered internally regulated alternators are perfect if you have added a set of high powered headlights or a high powered stereo system or any other electronic systems to your Camaro. Although meant for 1971 and newer, internally regulated setups can be used on older models that have been converted from external to internally regulated.

- TUF-7127NB 80 Amp, 1 Wire, Chrome 126.99 ea.
- TUF-7127D 100 Amp, 1 Wire, Cast Finish 92.99 ea.
- TUF-7127NF 100 Amp, 1 Wire, Black 126.99 ea.
- TUF-7127ND 100 Amp, 1 Wire, Chrome 126.99 ea.
- TUF-7127NDP 100 Amp, 1 Wire, Polished Alu 126.99 ea.
- TUF-7127NC 100 Amp, 3 Wire, Chrome 109.95 ea.
- TUF-7127K 140 Amp, 1 Wire, Cast Finish 131.99 ea.
- TUF-7127NK 140 Amp, 1 Wire, Chrome 145.99 ea.
- TUF-7139ABULL 100 Amp, Silver Bullet, 1 Wire, Chrome 163.99 ea.
- TUF-7140FBULL 140 Amp, Silver Bullet, 1 Wire, Black 180.99 ea.
- TUF-7140ABULL 140 Amp, Silver Bullet, 1 Wire, Chrome 219.99 ea.

Tuff Stuff Alternator Accessories

- TUF-7500A Chrome Alternator Case Kit 65.99 kit
- TUF-7600A Chrome Fan & Pulley Kit, Single Groove 23.99 kit
- TUF-7600B Chrome Fan & Pulley Kit, Double Groove 26.99 kit
- TUF-7610E Chrome Alternator Pulley, Single Groove 17.99 ea.



APX-1724

Alternator Fan Kit

Correct AC Delco fan zinc plated as original. Comes with special nut.

- APX-1724 All Fan / Nut 15.95 kit



ABN-105



ABB-5790

Alternator Pulleys

- ABB-5799 Standard (2 3/4" OD) 20.95 ea.
- ABB-5790 All w/ SHP (3 1/4" OD) 39.95 ea.
- ABN-105 Correct Retaining Nut 3.99 ea.

GCS-S9487



Billet Alternator Pulleys

Show quality billet alternator pulleys.

- GCS-S9487 1 Groove, Satin 20.79 ea.
- GCS-S9487POL 1 Groove, Polished 25.59 ea.
- GCS-S9447 2 Groove, Chrome 14.39 ea.



AVC-1144

APX-2559



Alternator Pigtail & Boot

Correct plug in "pigtail" for rear of alternator.

- AVC-1144 1967-81 All Pigtail 4.95 ea.
- APX-2559 Rear Alternator Boot 4.95 ea.

GCS-S6679



Alternator Dress Up Kit

This kit is designed to take your stock internally regulated alternator and make it show ready. This kit includes a chrome alternator case, pulley, fan and hardware.

- GCS-S6679 1973-85 GM 35.19 kit

Note: For 1973-85 internal regulated alternators only.



AR-0180

1967-68 Z/28

Alternator Bracket Kit

Correct upper and lower bracket stamped "GT" for all 1967-68 SB.

- AR-0180 1967-68 Z/28 79.95 kit



AA-45KIT

Big Block Alternator Bracket Kit

This is a complete set of alternator brackets and hardware for your Camaro big block with short water pump. This kit works on all cars with short water pumps.

- AA-45KIT 1967-68 BB Short Pump 75.55 kit



KK-301

1969-81 Big Block Alternator Mounting Kit

OE style reproduction of upper-lower brackets, lower mounting stud, lower spacer-brace and upper adjustment bolt w/ special washer

- AKK-301 1969-81 All BB 69.99 kit

Small Block Alternator Brackets

OE style reproduction alternator brackets for your small block Chevy



AAB-3400

- AAB-3400 1967-68 SB Upper 29.95 ea.



AAB-64L

- AAB-64L 1967-68 SB Lower 39.95 ea.

For exhaust manifolds.



AAB-65L

- AAB-65L 1967-68 SB Lower 17.95 ea.

Use with AAB-64L if you have headers.



ACE-5333

- ACE-5333 1969-81 SB Lower 16.95 ea.



ACE-2956

- ACE-2956 1969-81 SB Upper 29.99 ea.

Big Block Alternator Brackets

OE style reproduction alternator brackets for your big block Chevy.



AAB-4500

- AAB-4500 1968 BB Upper 19.95 ea.



ARZ-0027

- ARZ-0027 1968 BB Lower 46.95 ea.



AK-173

- AK-173 1969-72 BB Upper 36.95 ea.











AK-175

- AK-175 1969-72 BB Lower 29.95 ea.

OE Style Chrome Alternator Brackets





These high quality brackets will give your show car that finishing touch!

	GCS-S9315	SB Upper SWP..... 14.99 ea.		GCS-S9637	SB Lower LWP (69-75)..... 5.94 ea.		GCS-S9318	BB Upper LWP (69-92)..... 13.49 ea.
	GCS-S9316	SB Upper LWP (69-75)..... 13.49 ea.		GCS-S9502	BB Lower SWP..... 27.99 ea.		GCS-S9638	BB Lower LWP (69-92)..... 5.94 ea.
	GCS-S9317	SB Upper LWP (76-86)..... 12.79 ea.		GCS-S9581	BB Upper SWP 11.99 ea.		GCS-S9254	Bracket for Headers..... 10.39 ea.

Note: SWP = Short Water Pump. LWP = Long Water Pump.





Custom Style Alternator Brackets

These chrome plated steel alternator brackets will give your engine a unique custom look that will stand out from the crowd.

	GCS-S9319	SB Upper SWP..... 11.99 ea.		GCS-S9320	V8 Upper LWP (69-75)..... 10.39 ea.		GCS-S1637	SB Upper LWP (76-86)..... 15.29 ea.
	GCS-S9321	SB Upper LWP (76-86)..... 12.99 ea.		GCS-S1647	BB Upper LWP (69-92)..... 15.29 ea.			

Alternator Hardware

All of the correct hardware needed to mount your alternator!

	BRB-938	1969-72 SB Lower Bolt..... 4.95 ea.
	BN-339	1969-72 BB Lwr Stud/Nut..... 10.99 ea.
	APX-1138	1969-72 SB Spacer Brace..... 17.99 ea.
	APX-1038	1969-72 BB Spacer/Brace..... 15.95 ea.

	AWB-1114	1964-72 Upper Adjustment Kit..... 5.99 kit
---	----------	--

	ABC-23	1969-72 Bat Cable Clip SB..... 13.95 ea.
---	--------	--

For top of alternator

	ATE-5416	1969-72 Heater Hose Retainer..... 6.99 ea.
---	----------	--

For top of alternator

	BZ-117	1968 BB 396,427..... 15.99 kit
---	--------	--------------------------------

Alternator Mounting Kits

These complete kits make installing your alternator and bracket easy.

G-4828	1967-68 Z/28..... 16.99 kit
G-4645	1967-68 327, 350..... 14.99 kit
G-4766	1967-68 396,427..... 16.99 kit
BZ-117	1968 BB 396,427..... 15.99 kit
G-4962	1969-74 SB All..... 14.99 kit

	AW-506	1964-72 Neg Cable Ground Bolt/Washer..... 0.95 ea.
---	--------	--



ACL-1430

Hood Valve Frame

Correct steel frame inside of hood to support the flipper door.

- ACL-1430 1967-69 Hood Valve Frame26.99 ea.
- BCX-130 Attaching Screws 8pc5.95 kit



ACX-012

Valve Frame (Flipper) Door

This is the electrically controlled air door which mounts to the valve frame

- ACX-012 1967-69 Flipper Door 14.99 ea.



ACL-1684

Valve Frame Door Clips

Correct clip set to attach the flipper door to the frame.

- ACL-1684 1967-69 Valve Frame Clips 3pc5.99 kit



AXE-127

Valve Frame Seal

Correct seal used to seal frame to hood.

- AXE-127 1967-69 Frame Seal 6.95 ea.



ACG-67F1B

Style 1 in Black Anodized



ACG-67F2B

Style 2 in Black Anodized



Cowl Hood Grilles

If you're tired of looking at the hole in the back side of your cowl hood, this 1967-1969 Camaro cowl hood grille is the answer. Constructed of 16 gauge aluminum, this cowl hood grille will keep things looking neat while keeping out debris.

- ACG-67F1C 1967-69 Style 1 Clear Anodized ...41.99 ea.
- ACG-67F1B 1967-69 Style 1 Black Anodized ... 41.99 ea.
- ACG-67F1P 1967-69 Style 1 Polished..... 41.99 ea.
- ACG-67F2C 1967-69 Style 2 Clear Anodized ... 41.99 ea.
- ACG-67F2B 1967-69 Style 2 Black Anodized ...41.99 ea.
- ACG-67F2P 1967-69 Style 2 Polished.....41.99 ea.



ACI-3335

Cowl Induction Throttle Arm

OE style reproduction of arm which is used in conjunction with gas pedal.

- ACI-3335 1967-69 w/ Cowl Induction 18.99 ea.
- ADR-476 1967-69 w/o Cowl Induction 19.99 ea.



AEH-9602



Air Cleaner Valve Relay

This relay sends the "hot" signal to solenoid

- AEH-9602 1967-69 Relay 27.99 ea.



ACI-3685

Cowl Induction Electric Solenoid

Correct electric solenoid with part number stamped on.

- ACI-3685 1967-69 w/ GM Stamp 36.99 ea.
- AD-007



AQW-1176

Cowl Induction Solenoid Switch

Correct throttle switch and clip for activating solenoid.

- AQW-1176 1967-69 Switch..... 19.99 ea.
- AD-007 1967-69 Clip..... 5.99 ea.



AHQ-1143



AQW-296

Cowl Induction Harness & Grommet

OE style reproduction of original GM harness and correct rubber grommet for routing harness through firewall.

- AHQ-1143 1967-69 Harness42.99 ea.
- AQW-296 1967-69 Grommet..... 8.99 ea.



APJ-1314

Accelerator Rod Grommet Kit

- APJ-1314 1967-69 Most7.95 kit



APA-68

Accelerator Pedal Linkage Kit

New assemblies complete from the pedal to the arm and includes the pedal trim.

- APA-68 1967-69 V8 w/o Cowl Ind57.95 kit
- APA-69CI 1967-69 w/ Cowl Ind59.99 kit



APA-6CBH



Throttle Linkage To Cable Conversion Kit

Remove the old sticky linkage and upgrade to a smooth operating throttle cable set up. This kit includes the accelerator pedal assembly, accelerator cable, cable bracket and cable retaining clip.

- APA-6CBH 1967-69 Holley 105.64 kit
- APA-6CBQJ 1967-69 Q-Jet..... 108.04 kit



APA-9Z

Cross Ram & 6 Cyl Pedal Linkage

Correct pedal linkage for all cross ram and 6 cylinder cars.

- APA-9Z 1967-69 69.95 ea.



AY-12

Accelerator Rod Support

Correct support bracket used to hold rod in place. Complete with screws.

- AY-12 1968-69 (Plastic)..... 16.99 ea.



AEM-67FS

Engine Mounting Kits

Perfect for converting to a V8 or for upgrading your small block to a big block! Each kit includes all of the necessary motor mounts, frame brackets, motor mount thru bolts, frame bracket bolts and motor mount to block bolts so you can do the job right!

AEM-67FS	1967-68 All SB	74.23 kit
AEM-67FB	1967-68 All BB	99.03 kit
AEM-67FS	1969 SB except 302 or 350	74.23 kit
AEM-69FZO	1969 302 or 350 OEM	114.56 kit
AEM-69FBO	1969 All BB OEM	134.23 kit
AEM-70FBO	1970-81 All BB	129.59 kit

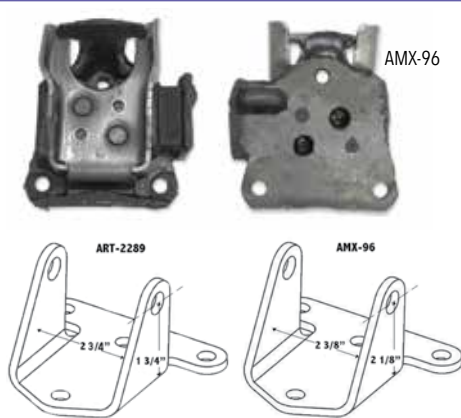

AMX-96

ART-2289

AMX-96

Motor Mounts OEM

These new motor mounts are from GM's original supplier!
MADE IN USA!!!

ART-2289	1967-68 All, 1969 All except 350	32.95 pr.
AMX-96	1969 302 350, 1969-81 BB	69.95 pr.

Please measure your frame brackets before ordering.
Use ART-2289 with AMC-10SB & AMC-103. Use AMX-96 for ACE-9794.



AQW-1339

Frame Brackets

OE style reproduction of the long discontinued GM brackets for mounting the engine to frame of car. Sold in matched pairs.

AQW-1339	1967-68 SB	34.99 pr.
ATE-5978	1967-68 BB	65.99 pr.
AQW-1339	1969 SB except 302 or 350	34.99 pr.
AR-397	1969-70 302 or 350	59.95 pr.
ACE-9412	1969 BB	74.99 pr.
AW-324	1970-81 BB	79.99 pr.

ENERGY SUSPENSION
Performance POLYURETHANE Components



3-1116G

3-1117G

Poly Motor Mounts

Energy Suspension motor mounts can take the abuse of todays high performance engines. Poly bushings can last longer than stock rubber mounts while handling more power, yet still able to absorb most driveline vibrations. Add **G** to the part number for black. Add **R** to the part number for red.

3-1114_	1967-72 SB 2-5/8" x 3/4" H	44.99 ea.
3-1117_	1967-72 BB 2-3/8" x 1-3/16" H	48.99 ea.
3-1116_	1973-92 SB*	29.99 ea.
3-1120_	1969-72 SB w/ Trans Mount	112.47 ea.
3-1122_	1969-72 BB w/ Trans Mount	126.32 ea.

Two mounts required per car. *You must reuse your original clamshells on the 1973-92 applications by drilling out the rivets and replacing the rubber insert with the new poly mount.



ENG-67FS-G

Poly Engine Mount Kits

Same as our OE style engine mount kits with upgraded Energy Suspension Poly motor mounts. The poly mounts can take the abuse of todays high performance engines, yet still absorb driveline vibrations. Add **G** to the part number for black. Add **R** to the part number for red.

ENG-67FS_	1967-68 SB Except 302-350	128.85 kit
ENG-67FB_	1967-68 BB	153.65 kit
ENG-69FZO_	1969 SB 302-350	154.42 kit
ENG-69FBO_	1969 BB	166.45 kit
ENG-70FBO_	1970-81 BB	170.45 kit

No volume discount.



HED-03832

Hedman LS Conversion

Do you want to swap an LSx into your Camaro? Get one of these Hedman LS conversion motor mount kits. These kits are designed to make swapping that LS Series small block Chevy into your Camaro easy. These kits include new frame brackets, motor mounts, a transmission crossmember, hardware and polyurethane bushings where needed. The conversion parts feature a durable silver powdercoated finish to make them look great and protect them from the elements.

HED-03832	1967-69 w/ 4L80E	548.97 kit
HED-03831	1967-69 w/ 4L60E, 4L65E	548.97 kit
HED-03830	1967-69 w/ T-56 6 Speed	548.97 kit
HED-03834	1970-81 w/ 4L60E, 4L65E	548.97 kit
HED-03833	1970-81 w/ T-56 6 Speed	548.97 kit
HED-03836	1982-92 w/ 4L60E, 4L65E	548.97 kit
HED-03835	1982-92 w/ T-56 6 Speed	548.97 kit

No Volume Discount. Not eligible for free shipping.



HKR-12512HKR

Hooker Blackheart LS Swap Engine Mount

Facilitates the installation of any LS style GM engine into Camaro or Firebird.

- Bolt-in compatibility with the Hooker BlackHeart transmission swap components
- Drilling template is included for installation on cars originally equipped with frame stands
- Fully compatible with Holley LS swap oil pan and accessory drive brackets.
- Engineered 3 to 3.5 degree engine/transmission inclination
 - Mounting hardware included
- LS Oil Pan 302-2 will work with these engine mount brackets

HKR-12512HKR	1970-74 LS	164.99 kit
--------------	------------	------------

No volume discount.



APX-2339

Frame Bracket Attaching Bolt Kit

Correct OEM bolts, washers and locking nuts as original.

APX-2339	1967-81 All V8	6.95 kit
----------	----------------	----------



BJ-998

Motor Mount Attaching Bolt Kit

Correct style bolts for attaching mount to block

BJ-998	All 12pc	8.95 kit
--------	----------	----------



APB-7057

Motor Mount "Thru" Bolt Kit

Correct OEM bolts for retaining mount to frame bracket. Comes complete with special high strength washers and cadmium plated locking nuts as original

APB-9057	4.5"	8.95 kit
APB-7057	3.5"	6.95 kit



ATW-2853

Motor Mount Clip

Correct clip for attaching positive cable to right side motor mount.

ATW-2853	Most V8	19.95 ea.
----------	---------	-----------



Vintage Air SureFit Kits

Vintage Air SureFit kits are the most complete, bolt-in climate control systems available for your Camaro SureFit kits install easily and utilize most of the factory sheet metal and body features and are engineered as "vehicle specific" complete systems.

Our SureFit kits are designed to place the evaporator case and air duct hoses behind the dash for a factory-clean look. In most cases, the SureFit system will be controlled by your stock dash controls using our exclusive patented "Cable Converters." In some applications, a new "factory" look control panel is included with the kit.

All SureFit systems provide full OEM-style operations including air conditioning, floor or vent exit heating and a powerful dehumidified defroster. To retain a true factory look, the A/C air exits through the factory dash louvers, if originally equipped in your car's dash. SureFit kits also offer the most complete and straightforward installations available anywhere. Our award-winning instruction booklets and carefully engineered system packages should make your SureFit installation job simple, fun and very cool!

The Gen IV is Vintage Air's most powerful and intelligent climate control system available for your Camaro. The Gen IV uses an exclusive fully electronic microprocessor control system that eliminates cables or vacuum connections. Separate high-capacity copper parallel-flow heat coil and aluminum plate-and fin-cooling coils provide outstanding performance and instant temperature adjustments.

Complete kits include the evaporator unit and mounting brackets, louvers (where required), duct hose, wiring harness, patented Electronic Cable Converters, compressor, engine brackets, condenser with brackets, preformed refrigerant lines, drier, fittings, hardware and installation instructions.

Features Include:

- Fly-By-Wire fully electronic servo motor controls with no cables or capillary tube to route
- Infinite just-right-temperature air blending
- Infinite blower fan speed adjustment (3-speed on factory air models)
- High-volume dehumidified defrost mode
- Separate high-capacity aluminum plate & fin cooling coil
- Copper/brass CuproBraz™ parallel-flow heater coil
- Mounts behind the dash
- Uses your factory system controls with our patented Electronic Cable Converters
- Flat steel firewall cover panel
- Replacement molded glove box (reduced capacity)



**** Vintage Air items**
Can not ship to
Addresses in California.**

VA-964190	1967-68 All With Factory Air.....	1389.99 kit
VA-961190	1967-68 All Without Factory Air.....	1389.99 kit
VA-964169	1969 All With Factory Air.....	1389.99 kit
VA-961169	1969 All Without Factory Air.....	1389.99 kit
VA-965070	1970-73 All With Factory Air.....	1389.99 kit
VA-961170	1970-73 All Without Factory Air.....	1389.99 kit
VA-965073	1974-77 All With Factory Air.....	1389.99 kit
VA-961173	1974-77 All Without Factory Air.....	1389.99 kit
VA-965078	1978 All With Factory Air.....	1389.99 kit
VA-961178	1978 All Without Factory Air.....	1389.99 kit
VA-965080	1979-81 All With Factory Air.....	1389.99 kit
VA-961180	1979-81 All Without Factory Air.....	1389.99 kit

No volume discount. Ships oversize. Not eligible for free shipping.



Engine Master Hardware Kits

The authentic hardware you need to correctly reassemble the engine components that attach to the long block. Typical kits include fasteners for: air cleaner, carburetor & choke cover, crank pulley & damper, distributor, exhaust manifold, exhaust pipe, engine fan, fuel pump plate & plug, seat shroud, ignition coil & strap, intake manifold & plug, oil filter valve, oil pan, PCV adapter, PCV hose clamps, timing cover, valve covers, water neck, water pump.

67-Z/28	1967-68 SB Z/28 174pc.....	109.99 kit
66-SBS	1968 SB w/o AC 153pc.....	120.99 kit
66-SBA	1968 SB w/ AC 164pc.....	114.99 kit
68-BBH	1968 BB Aluminum Intake 149pc.....	126.99 kit
68-BBS	1968 BB Cast Iron Intake 159pc.....	126.99 kit
69-SB	1969-71 SB 170pc.....	114.99 kit
69-Z28	1969 SB Z/28 162pc.....	108.99 kit
69-BBH	1969-72 BB Aluminum Intake 149pc.....	124.99 kit
69-BBS	1969-72 BB Cast Iron Intake 143pc.....	108.99 kit
72-SB	1972-73 SB 139pc.....	115.99 kit
72-Z28	1972-73 Z/28 145pc.....	111.99 kit

No Volume Discount

A/C Receiver Dryers

New Delco dryers.



ZAC-3	1967-69.....	69.95 ea.
-------	--------------	-----------



Air Conditioning Line

New pre-bent compressor line with correct fittings and compressor muffler. All V8.

ZACL6970SB	1969-70 SB 350.....	179.95 ea.
ZACL6970A	1969-70 BB 396.....	179.95 ea.

These lines will only work with correct original A/C components.



A/C Receiver Dryer Brackets

Correct air conditioning receiver dryer brackets.

ADB-117	1967.....	36.95 pr.
ADB-118	1968-69.....	36.95 pr.

1967 requires a nut and bolt.
1968-69 requires a self tapping bolt.

ACB-119













A/C Condenser Brackets

Correct brackets for mounting original air conditioning condenser.

ACB-119	1967-69.....	23.95 pr.
---------	--------------	-----------

Air Conditioning Brackets Big Block

OE style reproduction brackets for installing original Delco air conditioning compressors in all 1969-72 Camaros with big blocks using long water pumps.

	ZAC-A1			ZAC-A4			ZAC-B2
		ZAC-A4	1969-70 Rear Compressor Plate.....	24.95 ea.			
ZAC-A1	1969-70 Rear Compressor Bracket.....	44.95 ea.		ZAC-A5			ZAC-B3
		ZAC-A5	1969-71 Lower Bracket (to head).....	46.95 ea.			
	ZAC-A2			ZAC-A6			ZAC-B4
ZAC-A2	1969-70 Front Bracket (on head).....	69.95 ea.	ZAC-A6	1969-70 Rear Compressor Spacer.....	21.95 ea.		
	ZAC-A3			ZAC-B1			ZAC-B5
ZAC-A3	1969-70 Front Compressor Bracket.....	44.95 ea.	ZAC-B1	1970+ Compressor to Intake Bracket ...	26.95 ea.	ZAC-B5	1972+ Lower Bracket (to head).....
							44.95 ea.

1969-70 1st Design AC Brackets

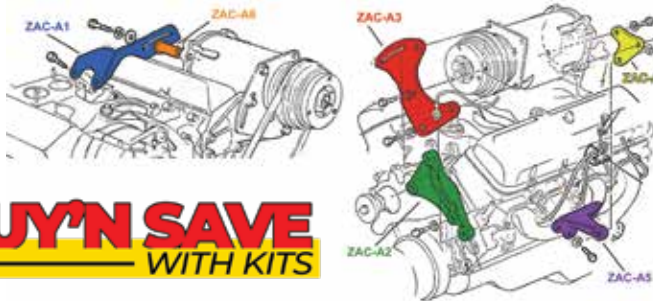

1970-75 2nd Design AC Brackets

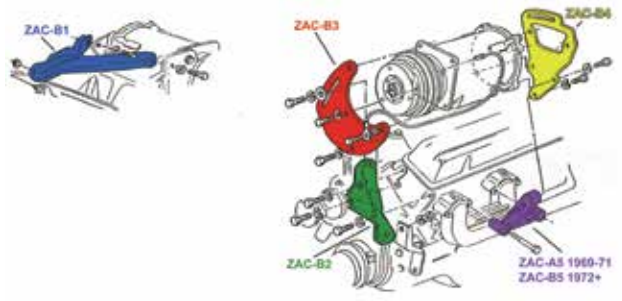

BUY'N SAVE
WITH KITS

Buy a complete set of big block air conditioning brackets and save! The design changed midway through 1970, so be sure to check your original brackets for early style (ZAC-AKIT) or late style (ZAC-BKIT).

ZAC-AKIT	1969-70 BB.....	228.33 kit
ZAC-BKIT	1970-71 BB.....	208.58 kit
ZAC-BKIT2	1972 BB.....	206.78 kit

AC On Engine Hardware

All the hardware related to the AC brackets on the engine.

66AA-SB	1967 SB	32.99 kit
67AA-SB	1967 SB w/ Smog	34.99 kit
68FA-SB	1968 SB	38.99 kit
68FA-SBB	1968 SB w/ Smog	41.99 kit
68FA-BB	1968 BB	44.99 kit
69AA-SB	1969 SB	46.99 kit
69AA-BB	1969 BB	35.99 kit
70AA-SB	1970 SB	37.99 kit
70AA-BB	1970-72 BB	36.99 kit
71AA-SB	1971 SB	35.99 kit
72AA-SB	1972-73 SB	38.99 kit





AWM-4169R

AWM-8242



Windshield Wiper Motors

Correct replacement wiper motors. Great to replace your tired original!

AWM-83T	1967 2 Spd 3 Terminal.....	149.95 ea.
AWM-84T	1967 2 Spd 4 Terminal.....	149.95 ea.
AWM-8242	1968-72 w/o Hidden.....	154.95 ea.
AWM-4169R	1970-73 w/ Hidden.....	139.95 ea.
AWM-4169	1970-73 w/hidden OE Style.....	169.95 ea.
AWM-162	1973-81 2nd Design No Delay ...	139.99 ea.
AWM-168	1977-81 w/ Delay System*.....	99.95 ea.

*For intermittent or pulse action wipers. No Volume Discount.



APW-2432



APW-2401-XX



APW-2401

Wiper Motor Mounting Kit

Correct steel rubber grommets & screws for mounting motor to firewall.

APW-2432	1967-81 All w/o Hidden Wipers.....	11.95 kit
APW-2401	1970-81 All w/ Hidden Wipers.....	11.95 kit
APW-2401-XX	1970-81 All w/ Hidden Wipers w/ Ground Strap.....	16.95 kit
APW-STRAP	1967-81 Ground Strap w/o Hidden Wipers.....	3.99 ea.
APW-STRAP-L	1970-81 Ground Strap w/ Hidden Wipers.....	5.99 ea.
FMP-CLIP	1967-81 Clip.....	4.95 ea.



AWA-085

Wiper Motor Arms with Ball Studs

These are the correct arms with studs that attach to the motor itself.

AWA-085	1967 All.....	14.99 ea.
AWA-086	1968-69 All.....	14.99 ea.

AWS-992



AWM-SEAL

Wiper Motor Seals

Correct foam rubber seal for wiper motors.

AWS-7	1967 All.....	6.99 ea.
AWS-792	1968-69 w/o Hidden.....	5.99 ea.
AWS-992	1970-77 w/ Hidden.....	5.99 ea.
AWM-SEAL	1970-81 w/ Hidden on Motor.....	8.99 ea.



AWP-6971W



AWP-6971-2D

OEM Style Washer Pump

New OE style reproduction washer pump with correct white nozzles! Fits cars with hidden wipers.

AWP-6971W	1970-74 1 st Design.....	44.95 ea.
AWP-64C	1970-74 1 st Design Cover Only.....	14.95 ea.
AWP-6488	1967-74 Single Speed Cover Only....	12.95 ea.
AWP-6971-2D	1970-78 2 nd Design.....	49.95 ea.



AWP-6971

Washer Pump

AC Delco replacement washer pumps will fit and function as original. Fits cars without hidden wipers.

AWP-6971	1967-73.....	49.99 ea.
----------	--------------	-----------



AHL-5400

Washer Pump Repair Kit

Correct white plastic nozzle, rubber seals and screws to repair your original washer pump.

AHL-5400	1967-69.....	11.95 ea.
----------	--------------	-----------



ACQ-100

Washer Nozzles

OE style reproduction washer nozzles, complete with correct mounting screws.

ACQ-100	1967-69 All.....	16.95 pr.
AWN-301	1970-81 All.....	22.95 pr.
AVN-101	Correct Screws.....	0.95 pr.



APH-1132

Washer Hose Kit

Correct GM ribbed thin walled style washer hose in pre cut lengths (7/32 - 11/32 diameter).

APH-1132	1967-69 All.....	11.95 kit
----------	------------------	-----------



AWJ-0892

Washer Jars

Correct white plastic washer jars.

AWJ-0083	1967-69 All.....	6.99 ea.
AWJ-0892	1970 All.....	16.95 ea.
AWJ-7038	1975-78*.....	18.99 ea.
AWJ-7039	1977-81.....	17.99 ea.
AWJ-0892K	1970 w/ Cap.....	21.17 kit
AWJ-0083-CAP	1967-69 1st Design w/ Cap.....	12.70 kit
AWJ-8368F	1982-87.....	38.95 ea.

*Fits 1977-78 models with washer pump mounted on the wiper motor.



AWB-8939



AWB-1206

Washer Jar Bracket

Correct bracket for mounting jar to fender.

AWB-8939	1967-69 Bracket.....	11.99 ea.
AWJ-10M	Mounting Screws.....	0.95 pr.
AWB-1363	1968 RS Adapter Bracket.....	10.99 ea.
AWB-1206	1969 RS Adapter Bracket.....	11.99 ea.
AVX-97RS	1968-69 RS Bracket Screws.....	1.00 kit
AWB-527	1977-81 Bracket.....	14.99 ea.



APX-9738

Washer Cap Kit

Correct GM cap, ribbed hose & pick up screen.

APX-9738	1967-81 All Cap Kit.....	7.95 kit
AWJ-8372	1967-81 Cap Only.....	4.95 ea.
AWJ-100	1967-81 Screen Only.....	2.95 ea.



DSE121301



DSE Selecta-Speed Wiper Kits

DSE's wiper kit contains a low profile, seven-speed wiper motor with 5 delays, low speed, high speed, a rotary switch with a billet knob to match your vehicle, adapter plate and wiring harness. The CNC hard coated aluminum adapter plate mounts the wiper motor to the stock firewall bolt pattern.

DSE121001	1967 All	549.99 kit
DSE121301	1968 All	549.99 kit
DSE121401	1969 All	549.99 kit
DSE121402	1970-72 (Non Recess Park)	549.99 kit
DSE121404	1973-74 (Non Recess Park)	549.99 kit
DSE121406	1975-77 (Non Recess Park)	549.99 kit
DSE121408	1978 (Non Recess Park)	549.99 kit

No Volume Discount



R59-TOP



R89-TOP

Battery Toppers

This new plastic injection molded cover will give your modern battery the look and feel of an original! This topper works with Group 24-60 sized batteries only. Inside size = 6-7/8" x 10-3/8".

R59-TOP	1967-72 R-59	44.95 ea.
R89-TOP	1969-72 R-89 Side	44.95 ea.



ASR-678FSB



ASR-69FBB

Spring Ring Cables

OE style reproduction of the original factory installed spring type cables sold as a matched pair with GM numbers.

ASR-678FSB	1967-68 SB	118.98 pr.
ASR-678FBB	1967-68 BB	118.95 pr.
ASR-69FSB	1969 SB	118.95 pr.
ASR-69FBB	1969 BB	118.92 pr.
ASR-70F	1970-73 All	89.00 pr.



AST-1001

Side Terminal Battery Cables

Correct cables for cars with the heavy duty R-89 batteries with correct GM part numbers.

AST-1001	1969 R-89	99.99 kit
----------	-----------	-----------



GCS-S6323

Billet Aluminum Battery Trays

Secure your battery in style! Fits Optima batteries.

GCS-S6323	Optima Group	
	34/78 Top/Side Post	59.19 kit
GCS-S6324	Optima Group	
	35 Top Post	59.19 kit
GCS-S6325	Optima Group	
	75/25 Top/Side Post	67.19 kit



ABR-9533



ABT-6006

Battery Trays

OE style reproduction EDP coated battery trays.

ABT-6006	1967-69 All Tray	16.95 ea.
ABT-6006K	1967-69 All Tray Retainer w/ Bolt	16.72 kit
ABT-7081	1970-81 All Tray	16.95 ea.
ABT-7081K	1970-81 All Tray Retainer w/ Bolt	16.72 kit
ABR-9533	1967-81 Retainer w/ Bolt	3.95 kit



GCS-S9323

Universal Stainless Battery Tray

This polished stainless steel tray will secure your battery in style! Fits batteries measuring 7.5" L x 13.25" W x 9.25" tall.

GCS-S9323	Battery Tray	25.59 kit
-----------	--------------	-----------



AMH-15

Underhood Lamp

Complete with bracket, hardware, harness and built in switch.

AMH-15	All	39.99 kit
--------	-----	-----------



GRC-12835



GRC-12834

Radio Capacitor

Came from the factory on all cars with a radio. Correct length lead wire & brass connector.

GRC-12834	1967-71 Voltage Regulator	29.95 ea.
	Stamped 1964086 "DR" & ".5MF"	
GRC-12835	1970-1974 Radio	29.95 ea.
	1964452 "DR" & ".3MF"	



GAC-515



GAC-515GM

Voltage Regulator

New correct GM replacement.

GAC-515	1967-72 All D635	79.95 ea.
GAC-515GM	1967-71 OE Style Reproduction	89.95 ea.
AVX-515	1967-72 Screws 2pc	0.95 kit
AWX-818	1967-72 Mounting Kit	6.95 kit



GQH-118

Electric Junction Block

Original GM junction block for attaching positive lead from battery to main harness. Mounts to radiator support. Includes correct nut.

GQH-118 1967-71 All 9.95 ea.



GAC-560

GAC-760

GAC-660

Temp Sending Units

Correct screw in sending units.

GAC-250 1967-72 w/o Gauges 16.95 ea.
 GAC-560 1967-72 w/ Gauges* 16.95 ea.
 GAC-760 1969-70 w/ Gauges 32.95 ea.
 GAC-660 1970-72 TCS Sender 18.95 ea.

*Can be used with CPX-999 harness



CPX-999

Temperature Sending Unit Harness

Pre-cut wire section with correct clip and cloth insulator.

CPX-999 1967-72 w/ Gauges* 12.95 ea.

*For use with GAC-560 sender



ATCS-33R

TCS Littlefuse Relay

This is an OE style reproduction of the correct Camaro littlefuse TCS relay which was discontinued by GM in 1999. This authentic reproduction of the original transmission spark control relay vacuum advance delay features 4 prongs as original and replaces Delco number 3961573.

ATCS-33R 1970-72 54.95 ea.



GAC-660

TCS Temp Sending Unit

Correct 2 prong sending unit mounts on right side cylinder head. This unit sends both low and high temperature signals to the TCS vacuum switch for correct operation.

GAC-660 1970 All 18.95 ea.



GWC-70F

1970-81 Firewall Clip

Correct clip bolted or welded to firewall to hold main harness.

GWC-70F 1970-81 11.95 ea.



BCE-9738

APC-744

AHB-1X

Engine Compartment Retaining Hooks

Pre-bent hooks for various wires, cables and hoses.

BCE-9738 Large Rubber Coated 4.95 ea.
 APC-744 Small Hook (oil pan, etc.) 5.95 ea.
 AHB-1X Heater Box Wire Clip 4.95 ea.



AHC-1

AHC-2

Harness Retaining Clips

Correct retaining clips for harness.

AHC-1 Clip Style #1 4.95 ea.
 AHC-2 Clip Style #2 4.95 ea.



BPX-2350

Harness Retaining Straps

Correct push in style plastic retainers

BPX-2350 All 3.95 pr.



BJN-300

Harness Wire Ties

Original GM wire ties used on various hoses, cables and harnesses.

BJN-300 Short 3.99 ea.
 BJN-600 Long 7" 5.99 ea.



GDT-0330

Electrical Harness Tape

Correct non-stick factory style tape. Over 100 feet.

GDT-0330 All 11.95 ea.



ACY-100

Marking Crayons

Original crayons used to mark the frame and firewall. Includes (1) yellow crayon and (1) white crayon.

ACY-100 All 5.99 kit



ACY-KIT

Frame & Body Marking Crayon Kit

These paint sticks are used for final detailing to replicate the marks left on the frame, body and other parts of the car. Just like when it came down the assembly line!

ACY-KIT All 12pc 22.99 kit



ADR-3F

Horns

Choose from either OE style reproduction horns for your 1969 Camaro or reproduction style horns for all Camaros (slightly different from original).

ADR-3-GM 1967-77 Universal Horn Set 139.99 kit
 ADR-3F 1968 Excellent Reproduction Set . 144.99 pr.
 ADR-3H 1967-81 Replacement* 179.99 kit
 ADR-5F 1969 OE style Reproduction 144.99 pr.
 ADR-3-CHROME 1967-69 Repro Chrome 169.99 pr.
 *Brackets may require some modification.



GAC-723

Horn Relay

New reproduction of the original GM Delco style relay.

GAC-723 1967-71 52.95 ea.
 GAC-775 1972-73 54.95 ea.
 AVN-506 Mounting Screw 0.95 ea.



One Piece Design



Two Piece Design



Radiator Support Show Panels

This radiator support show panel seals up the unsightly area between the front of the radiator support and the header panel. It can be installed in about 15 minutes with no modification and will really make your engine compartment look clean and neat. Available with a number of popular logos. Add the appropriate letter for your choice of finish.

B = Black Anodized C = Clear Anodized P = Polished

1967-69 One Piece

		B or C	P
ASP-67F1SS	1967-69 SS	163.99 ea.	180.99 ea.
ASP-67F1CA	1967-69 "Camaro"	163.99 ea.	176.99 ea.
ASP-67F1BW	1967-69 Bowtie	163.99 ea.	176.99 ea.
ASP-67F1BC	1967-69 Bowtie/Chevrolet	155.99 ea.	176.99 ea.
ASP-67F1CH	1967-69 Chevrolet	163.99 ea.	176.99 ea.
ASP-67F1HB	1967-69 Heartbeat	163.99 ea.	176.99 ea.
ASP-67F1Z	1967-69 Z/28	163.99 ea.	176.99 ea.
ASP-67F1BM	1967-69 Ball Milled	155.99 ea.	182.99 ea.
ASP-67F1	1967-69 Plain	124.99 ea.	142.99 ea.

1967-69 Two Piece

ASP-67F2SS	1967-69 SS	169.99 ea.	191.99 ea.
ASP-67F2CA	1967-69 "Camaro"	169.99 ea.	191.99 ea.
ASP-67F2BW	1967-69 Bowtie	169.99 ea.	191.99 ea.
ASP-67F2BC	1967-69 Bowtie/Chevrolet	169.99 ea.	191.99 ea.
ASP-67F2Z	1967-69 Z/28	169.99 ea.	191.99 ea.
ASP-67F2	1967-69 Plain	135.99 ea.	151.99 ea.

1970-77 Camaro Non-RS

ASP-70FSS	1970-73 SS	155.99 ea.	176.99 ea.
ASP-__FCA	19__ Camaro*	155.99 ea.	176.99 ea.
ASP-70FBW	1970-77 Bowtie	155.99 ea.	176.99 ea.
ASP-70FBC	1970-77 Bowtie/Chevrolet	155.99 ea.	176.99 ea.
ASP-70FCH	1970-77 Chevrolet	155.99 ea.	176.99 ea.
ASP-70FHB	1970-77 Heartbeat	155.99 ea.	176.99 ea.
ASP-70FZ	1970-77 Z/28	155.99 ea.	176.99 ea.
ASP-70F	1970-77 Plain	124.99 ea.	135.99 ea.

1970-77 Camaro Non-RS with HD Cooling

ASP-70FSS_H	1970-73 SS	155.99 ea.	176.99 ea.
ASP-__FCA_H	19__ Camaro*	155.99 ea.	176.99 ea.
ASP-70FBW_H	1970-77 Bowtie	155.99 ea.	176.99 ea.
ASP-70FBC_H	1970-77 Bowtie/Chevrolet	155.99 ea.	176.99 ea.
ASP-70FCH_H	1970-77 Chevrolet	155.99 ea.	176.99 ea.
ASP-70FHB_H	1970-77 Heartbeat	155.99 ea.	176.99 ea.
ASP-70FZ_H	1970-77 Z/28	155.99 ea.	176.99 ea.
ASP-70F_H	1970-77 Plain	124.99 ea.	135.99 ea.

1970-73 Camaro RS

		B or C	P
ASP-70FSS_R	1970-73 SS	155.99 ea.	176.99 ea.
ASP-__FCA_R	19__ Camaro*	155.99 ea.	176.99 ea.
ASP-70FBW_R	1970-73 Bowtie	155.99 ea.	176.99 ea.
ASP-70FBC_R	1970-73 Bowtie/Chevrolet	155.99 ea.	176.99 ea.
ASP-70FCH_R	1970-73 Chevrolet	155.99 ea.	176.99 ea.
ASP-70FHB_R	1970-73 Heartbeat	155.99 ea.	176.99 ea.
ASP-70FZ_R	1970-73 Z/28	155.99 ea.	176.99 ea.
ASP-70F_R	1970-73 Plain	124.99 ea.	135.99 ea.

1970-73 Camaro RS with HD Cooling

ASP-70FSS_RH	1970-73 SS	155.99 ea.	176.99 ea.
ASP-__FCA_RH	19__ Camaro*	155.99 ea.	176.99 ea.
ASP-70FBW_RH	1970-73 Bowtie	155.99 ea.	176.99 ea.
ASP-70FBC_RH	1970-73 Bowtie/Chevrolet	155.99 ea.	176.99 ea.
ASP-70FCH_RH	1970-73 Chevrolet	155.99 ea.	176.99 ea.
ASP-70FHB_RH	1970-73 Heartbeat	155.99 ea.	176.99 ea.
ASP-70FZ_RH	1970-73 Z/28	155.99 ea.	176.99 ea.
ASP-70F_RH	1970-73 Plain	124.99 ea.	135.99 ea.

1978-81 Camaro

ASP-78FBW	1978-81 Bowtie	155.99 ea.	176.99 ea.
ASP-__FCA	19__ Camaro*	155.99 ea.	176.99 ea.
ASP-78FBC	1978-81 Bowtie/Chevrolet	155.99 ea.	176.99 ea.
ASP-78FCH	1978-81 Chevrolet	155.99 ea.	176.99 ea.
ASP-78FHB	1978-81 Heartbeat	155.99 ea.	176.99 ea.
ASP-78FZ	1978-81 Z/28	155.99 ea.	176.99 ea.
ASP-78F	1978-81 Plain	124.99 ea.	135.99 ea.

1978-81 Camaro with HD Cooling

ASP-78FBW_H	1978-81 Bowtie	155.99 ea.	176.99 ea.
ASP-__FCA_H	19__ Camaro*	155.99 ea.	176.99 ea.
ASP-78FBC_H	1978-81 Bowtie/Chevrolet	155.99 ea.	176.99 ea.
ASP-78FCH_H	1978-81 Chevrolet	155.99 ea.	176.99 ea.
ASP-78FHB_H	1978-81 Heartbeat	155.99 ea.	176.99 ea.
ASP-78FZ_H	1978-81 Z/28	155.99 ea.	176.99 ea.
ASP-78F_H	1978-81 Plain	124.99 ea.	135.99 ea.

* Please Specify your year. Example: ASP-70FCA = 1970 Camaro.

Note: Non-HD panel measures just under 24 inches. HD panel measures just over 28 inches.

See www.ss396.com for photos of all panels!



FG2007



FG2005



FG2003



FG2001



FG2042



FG2031



FG2046



FG2044

Fender Gripper

If you spend a lot of time working under the hood but don't want to scratch your paint a Fender Gripper is the answer! Made of non-slip material, the Fender Gripper will not slide off slick surfaces.

- Soft and cushioned for protection
- Tools will not slip off fender cover
- Completely washable 22 X 34 standard size

- Strong PVC product reinforced with nylon mesh
- Impervious to motor oil, coolant, lacquer thinner, brake fluid, etc.

- Many favorite brand logos are available
- Will not harm your paint

FG2001	Bowtie	25.95 ea.	FG2007	Chevrolet Racing	25.95 ea.	FG2042	General Motors	25.95 ea.
FG2003	Genuine Chevrolet	25.95 ea.	FG2048	El Camino	25.95 ea.	FG2044	SS	25.95 ea.
FG2005	Heartbeat of America	25.95 ea.	FG2031	Chevelle	25.95 ea.	FG2046	Super Sport	25.95 ea.

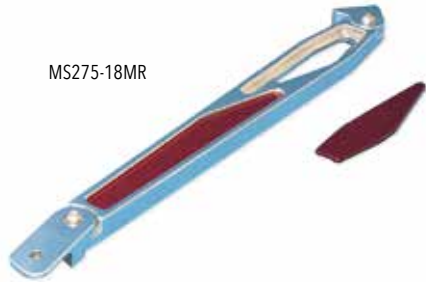

MS275-18MR

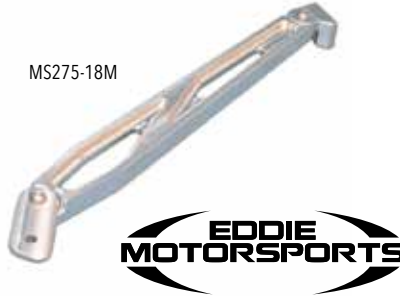

MS275-18M



Eddie Motorsports Billet Fender Braces

Brace Finish:

M = Machined, P = Polished, CL = Clear Coat, BKA = Gloss Black Anodized, CA = Clear Anodized

Insert Finish:

M = Machined, P = Polished, R = Red Fusioncoat, B = Blue Fusioncoat, W = White Fusioncoat, PR = Purple Fusioncoat, BK = Gloss Black Fusioncoat, BKA = Gloss Black Anodized, MB = Matte Black Fusioncoat, MBA = Matte Black Finish, CL = Clear Coat, CA = Clear Anodized

		M,P	All Others
MS275-18	1967-69 Billet Fender Braces	160.99 pr.	218.99 pr.
MS275-13	1070-73 Billet Fender Braces	194.99 pr.	218.99 pr.
MS275-19	1967-69 Fender Brace Inserts	31.99 set	35.99 set
MS275-14	1970-73 Fender Brace Inserts	31.99 set	35.99 set

DSE011801



Detroit Speed Fender Brace Kit

This new DSE Camaro fender brace kit is another way to beautify your engine compartment. The fender braces are 100 percent CNC machined Clevis' from 304 stainless steel. The kit includes fabricated mounting brackets and comes with button head stainless steel mounting bolts. The fender braces triangulate the radiator core support to the fender and are fully adjustable (a benefit not available with your stock fender braces). All mounting brackets come powdercoated satin black.

DSE011801	1967-69 All	208.99 kit
DSE011802	1970-81 All	208.99 kit

No Volume Discount



FDT-350



GCS-S9422

Transmission Dipsticks & Tubes

OE style replacement dipstick and tubes.

FDT-350	TH350 OE Style Tube	21.95 ea.
FDT-400	TH400 OE Style Tube	21.95 ea.
FDS-3	TH350 OE Style Stick	9.95 ea.
FDS-4	TH400 OE Style Stick	9.95 ea.

Chrome

GCS-S9422	Powerglide Chrome	11.19 ea.
GCS-S9421	TH350 Chrome	10.39 ea.
GCS-S9421BA	TH350 Billet Handle Chrome	17.59 ea.
GCS-S4994	TH350 34" Chrome	13.99 ea.
GCS-S4994BA	TH350 34" Billet Handle Chrome	17.99 ea.
GCS-S4995	TH400 24" Chrome	9.34 ea.
GCS-S4995BA	TH400 24" Billet Handle Chrome	11.99 ea.

Bell Housing Mount

GCS-S5004	TH350 Braided	36.54 ea.
GCS-S5005	TH400 Braided	36.54 ea.
GCS-S5006	TH700-R4 Braided	34.39 ea.

Firewall Mount

GCS-S5104	TH350/TH400 29" Braided	41.64 ea.
GCS-S5106	TH700-R4 Braided	41.64 ea.



ProStyle Cowl Induction Trim Plates

Dress up the unsightly hole in the back of the hood with a ProStyle cowl induction trim plate from Twist Machine. Airflow is not restricted. Includes stainless steel hardware.

TM-30040	1967-69 Brushed (Repro Hood)	72.95 ea.
TM-30140	1967-69 Black (Repro Hood)	82.95 ea.
TM-30045	1967-69 Brushed (GM Hood)	72.95 ea.
TM-30145	1967-69 Black (GM Hood)	82.95 ea.



NC-125

Hood Insulation

Correct die stamped OEM material for insulating the underside of the hood. A MUST for final detailing!

NC-125	1967-69 w/o Cowl	24.99 ea.
NC-126	1967-69 w/ Cowl	25.99 ea.
NC-135	1970-81 All	25.99 ea.



OE Molded Hood Insulation

Correct die-stamped molded hood insulation just like original GM.

AMI-5	1967-69 w/ Cowl	99.99 ea.
AMI-3	1967-69 w/o Cowl	103.99 ea.
AMI-7	1970-81	121.99 ea.
NQ-243	Clips	21.99 kit

Ships Oversize 2.

RFB-656



Stock Fender Support Bars

OE style reproduction fender support bars in your choice of factory black or show quality chrome.

RFB-656	1967-69 Black	16.99 pr.
RFB-653	1967-69 Chrome	18.99 pr.
RFB-7081B	1970-81 Black	18.95 pr.
RFB-7081C	1970-81 Chrome	18.95 pr.



Firewall Cover

A quick and easy way to cover up your rough firewall! Constructed of 16 gauge anodized aluminum which is easy to clean and can be painted to match your car. You only need to remove your hood, wiper motor, wire gutter and any accessories you've attached to your firewall and this panel will simply slide right in place. There is no need to remove your engine or even distributor!

AFC-67F	1967-69 Blank	135.99 ea.
AFC-67FW	1967 Wiper Hole	135.99 ea.
AFC-67FWH	1967 Wiper & Heater	135.99 ea.
AFC-68FW	1968-69 Wiper Hole	135.99 ea.
AFC-68FWH	1968-69 Wiper/Heater	135.99 ea.

It is recommended to install with silicone so the panel stays smooth and allows the body to flex behind it. This item ships Oversize.



Detail shot of a 1968 Camaro Master Body Hardware kit.
These kits have all of the hard to find items that are not available anywhere else!

What Your Body Needs! AMK Products

Master Body Kit

Master body kits contain just about every piece of hardware to assemble the body of your Camaro. Each kit contains hardware for your battery tray, bumpers, filler panel, filler panel moldings, bumper brackets, cowl vent panel, door latches, emblems, fender braces, fenders, front tie bar, grille, grille brackets, grille moldings, headlamps, headlamps bezels, hood, hood hinges, hood latch, hood latch support, license plate, mirrors, parking lamps, tail lamps, trunk latch, trunk lid hinges, wheel opening moldings, wheelhouses, radiator support and more! This kit truly has it all!

67FB-S	1967 Standard	223.99 kit
67FB-RS	1967 Rally Sport	222.99 kit
68FB-S	1968 Standard	223.99 kit
68FB-RS	1968 Rally Sport	223.99 kit
69FB-S	1969 Standard	223.99 kit
69FB-RS	1969 Rally Sport	221.99 kit
70FB-S	1970-72 Standard	222.99 kit
70FB-RS	1970-72 Rally Sport	219.99 kit
73FB-S	1973 Standard	231.99 kit
73FB-RS	1973 Rally Sport	219.99 kit
74FB	1974-76 All	249.99 kit
77FB	1977 All	284.99 kit
78FB	1978 All	304.99 kit
79FB	1979 All	259.99 kit
80FB	1980-81 All	270.99 kit

No Volume Discount.

AMK inc PRODUCTS



Master Chassis Kit

Typical kit includes fasteners to attach: accelerator lever & support, axle housing springs, axle retainer plates, brake booster & hose, brake cables, brake plates, brake hose retainers & brackets, brake valve & pressure switch, calipers & brackets & shields, upper & lower control arms, control arm bushings, differential cover, driveshaft, engine mounts, fuel filler neck cover, fuel hoses, gas tank, grease fittings, idler arm, leaf spring hangers & front eye, master cylinder & push rod, parking brake control, pitman arm, radius rod & bracket & bumper, shackles (nuts), shocks & brackets, stabilizer bar brackets and end links (includes rubber), steering gear & rag joint, steering linkage & ball joints, speedometer cable trans, suspension bumper, transmission crossmember & insulator, wheel cylinders.

67FS-BB	1967 BB Disc Brakes Mono Leaf	306.99 kit
67FS-DCSB	1967 SB Disc Brakes Mono Leaf	305.99 kit
67FS-DRSB	1967 SB Drum Brakes Mono Leaf	277.99 kit
67FS-L78	1967 BB L-78 Disc Brakes Mono Leaf	326.99 kit
67FS-Z28	1967 SB Z/28 Disc Brakes Mono Leaf	326.99 kit
68FS-BB	1968 BB Disc Brakes Mono Leaf	314.99 kit
68FS-DCSB1	1968 SB Disc Brakes Mono Leaf	315.99 kit
68FS-DCSB4	1968 SB Disc Brakes Multi Leaf	305.99 kit
68FS-DRSB1	1968 SB Drum Brakes Mono Leaf	278.99 kit
68FS-DRSB4	1968 SB Drum Brakes Multi Leaf	308.99 kit
69FS-BB	1969 BB Disc Brakes Multi Leaf	326.99 kit
69FS-DCSB1	1969 SB Disc Brakes Mono Leaf	323.99 kit
69FS-DCSB4	1969 SB Disc Brakes Multi Leaf	332.99 kit
69FS-DRSB1	1969 SB Drum Brakes Mono Leaf	301.99 kit
69FS-DRSB4	1969 SB Drum Brakes Multi Leaf	299.99 kit
70FS-BB	1970-71 BB Disc Brakes Multi Leaf w/ Swaybar	333.99 kit
70FS-F41SB	1970-71 SB Disc Brakes Multi Leaf w/ Swaybar	329.99 kit
70FS-SB	1972 SB Disc Brakes Multi Leaf	335.99 kit
72FS-BB	1972 Disc Brakes Multi Leaf w/ Swaybar	318.99 kit
72FS-F41SB	1972 SB Disc Brakes Multi Leaf w/ Swaybar	327.99 kit
72FS-SB	1972 SB Disc Brakes Multi Leaf	327.99 kit
73FS-F41SB	1973 SB Disc Brakes Multi Leaf w/ Swaybar	327.99 kit
73FS-SB	1973 SB Disc Brakes Multi Leaf	327.99 kit
74FS-S	1974 SB Disc Brakes Multi Leaf	276.99 kit
74-FS-F41	1974 SB Disc Brakes Multi Leaf F41	288.99 kit
75FS-S	1975-76 SB Disc Brakes Multi Leaf	280.99 kit
75-FS-F41	1975-76 SB Disc Brakes Multi Leaf F41	296.99 kit
77FS-S	1977 SB Disc Brakes Multi Leaf	288.99 kit
77-FS-F41	1977 SB Disc Brakes Multi Leaf F41	315.99 kit
78FS-S	1978-79 SB Disc Brakes Multi Leaf	360.99 kit
78-FS-F41	1978-79 SB Disc Brakes Multi Leaf F41	316.99 kit
80FS-S	1980-81 SB Disc Brakes Multi Leaf	327.99 kit
80-FS-F41	1980-81 SB Disc Brakes Multi Leaf F41	320.99 kit

No Volume Discount.

OEM

OEM Bolts - They Just Make Sense!

It makes sense to use new bolts on new or restored parts! From bumper to bumper, we cover your entire vehicle. We have made our name and reputation on providing those hard to find detailing parts that separates your classic from the rest. All of our bolts are either original, OEM parts from original GM manufacturers or top quality reproductions. Manufactured with original head markings and correct plating (zinc, black phosphate and oiled, gold cadmium and silver cadmium), these bolts make assembly a breeze! Like our OEM paints, new bolt sets are what make a top flight restoration!



APX-1724

Alternator Fan w/ Nut

APX-1724	All.....	15.95 kit
ABN-105	Nut Only.....	3.99 ea.



BRB-938



BN-339

Alternator Lower Attaching Hardware

BRB-938	1969-81 SB Bolt.....	4.95 ea.
BN-339	1969-81 BB Stud.....	10.99 ea.



AWB-1114

Alternator Upper Adjustment Kit

Correct WB head marked bolt with washers.

AWB-1114	1967-69 All.....	5.99 kit
----------	------------------	----------



AW-506

Alternator Neg Cable Bolt

AW-506	All.....	0.95 ea.
--------	----------	----------



APX-1038

Alternator Spacer Brace

APX-1038	1969-81 BB.....	15.95 ea.
----------	-----------------	-----------



BZ-117

Alternator Mounting Kits

These complete kits make installing your alternator and bracket easy.

G-4828	1967-68 Z/28.....	16.99 kit
G-4645	1967-68 327, 350.....	14.99 kit
G-4766	1967-68 396, 427.....	16.99 kit
BZ-117	1968 BB 396, 427.....	15.99 kit
G-4962	1969-74 SB All.....	14.99 kit



ABR-9533

Battery Retainer Kits

ABR-9533	1967-81 All.....	3.95 kit
----------	------------------	----------

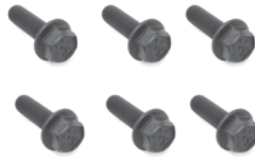

BPB-9021

Bellhouse Attaching Kit

BPB-9021	All 6pc.....	8.95 kit
----------	--------------	----------

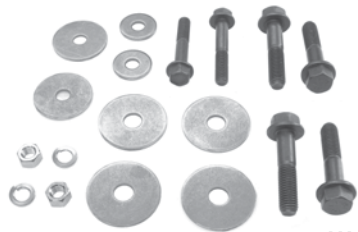

BPB-2230

Body Bolt Kit

Correct black flanged head bolts and washers.

BPB-2230	1967-81 All.....	24.95 kit
----------	------------------	-----------



BMP-1000

Brake Caliper Bolt

BMP-1000	All Single Piston.....	2.99 ea.
----------	------------------------	----------



BPX-97K

Bumper Bolts

Correct style replacement and OE style bumper bolt kits available.

BPX-97K	1967 All 10pc.....	14.95 kit
BPX-97KOE	1967 All 20pc.....	44.99 kit
BPX-99K	1968 -69 All 10pc.....	14.95 kit
BPX-99KOE	1968 -69 All 20pc.....	44.99 kit
BPX-2401KIT	1970-73 Std 10pc.....	17.95 kit
BPX-359	1970-73 RS 12pc.....	16.95 kit



BBF-13

Bumper Bracket Hardware

BBF-13	Bolt, Nut, Teeth Washers.....	6.99 ea.
--------	-------------------------------	----------



BCP-373

Caliper Backing Plate Bolt

BCP-373	Plate to Spindle.....	2.99 ea.
---------	-----------------------	----------



Engine Master Hardware Kits

The authentic hardware you need to correctly reassemble the engine components that attach to the long block. Typical kits include fasteners for: air cleaner, carburetor & choke cover, crank pulley & damper, distributor, exhaust manifold, exhaust pipe, engine fan, fuel pump plate & plug, shroud, ignition coil & strap, intake manifold & plug, oil filter valve, oil pan, PCV adapter, PCV hose clamps, timing cover, valve covers, water neck, water pump.

67-Z28	1967-68 SB Z/28 174pc.....	109.99 kit
66-SBS	1968 SB w/o AC 153pc.....	120.99 kit
66-SBA	1968 SB w/ AC 164pc.....	114.99 kit
68-BBH	1968 BB Aluminum Intake 149pc.....	126.99 kit
68-BBS	1968 BB Cast Iron Intake 159pc.....	126.99 kit
69-SB	1969-71 SB 170pc.....	114.99 kit
69-Z28	1969 SB Z/28 162pc.....	108.99 kit
69-BBH	1969-72 BB Aluminum Intake 49pc.....	124.99 kit
69-BBS	1969-72 BB Cast Iron Intake 143pc.....	108.99 kit
72-SB	1972-73 SB 139pc.....	115.99 kit
72-Z28	1972-73 Z/28 145pc.....	111.99 kit

No Volume Discount



BTE-1475



BMG-0095

Carburetor Attaching Kits

BTE-1475	All Q-Jet.....	8.95 ea.
BMG-0095	All Holley.....	7.95 ea.



BAN-516

Coil Bracket Screws

BAN-516	All with "L" Headmark.....	BAN-516
---------	----------------------------	---------



BPX-0918

Control Arm to Frame Bolts

4 serrated bolts and 4 locking nuts for one car.

BPX-0918	1967-69 All.....	18.99 kit
BPX-0919	1970-81 All.....	19.99 kit



DS-594

Control Arm Shims

DS-594	1/16".....	2.95 ea.
DS-595	1/8".....	2.95 ea.



BPX-8542

Control Arm Upper Washers

Complete kit to do one car.

BPX-8542	1967-69 All.....	19.95 kit
----------	------------------	-----------



BPB-1430

Control Arm Bolt Front Lower

BPB-1430	1967-72.....	7.99 ea.
BPB-1450	1973-81.....	6.99 pr.



BD-02V

Convertible Cross Brace Bolt

BD-02V	1967-69.....	1.00 ea.
--------	--------------	----------



BPC-7000

Crossmember Bolts

BPC-7000	To Frame.....	6.95 kit
BTE-7939	To Transmission.....	0.95 ea.



BPC-7939



NRM-1888

Cylinder Head Bolts

NRM-1888	All BB 32pc.....	69.95 kit
----------	------------------	-----------



ACE-1400

Distributor Hold Down

Correct retaining hardware for distributor.

ACE-1400	All.....	4.95 kit
----------	----------	----------



Door Hinge Bolts

BAV-2622	1967 Phillips.....	1.99 ea.
BAV-2623	1968-81 Hex.....	1.99 ea.



BPX-1225

Door Hinge Pin Kits

BPX-1225	1967-69 All.....	14.95 ea.
BPX-2225	1970-81 All.....	13.99 ea.



BPX-1275

BPX-1299

Door Strikers w/ Washer

BPX-1275	GM Replacement.....	9.99 ea.
BPX-1275-GSKT	All.....	4.95 pr.
BPX-1299	OE Style Reproduction*.....	11.99 ea.

*Correct Allen Head Zinc Plated

MS277-20P



Stainless Strikers

Awesome stainless 7/16" strikers from Eddie Motorsports.

MS277-20M	Machined.....	47.99 pr.
MS277-20P	Polished.....	53.99 pr.



APB-1382

APB-1821

Exhaust Manifold Bolts

With correct double circle logos.

APB-1382	All SB w/ Washers 24pc.....	27.99 kit
APB-3506	All BB w/ Washers 32pc.....	26.99 kit
APB-1821	All BB Flanged 16pc.....	23.99 kit



Exhaust Stud Kits

ALI-2228 OEM Steel 12pc.....24.99 kit



Fan Attaching Kits

BPX-2792 All w/ Clutch Studs6.95 kit
 BPX-2791 All w/ Clutch Bolts5.95 kit



Engine Bracket to Frame Bolt Kit

APX-2339 Brackets to Frame.....6.95 kit

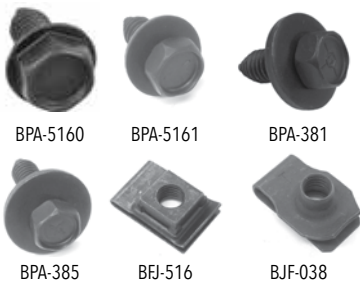

Fender Front End Bolts

BPA-5160 5/16" Bolt w/o Washer.....0.65 ea.
 BPA-5161 5/16" Bolt w/Washer.....0.55 ea.
 BPA-381 3/8" x 1" Bolt.....0.65 ea.
 BPA-385 3/8" x 1-1/2" Bolt.....0.75 ea.
 BEJ-516 Fender J Clip 5/16".....1.25 ea.
 BJJ-038 Fender J Clip 3/8".....1.50 ea.



Fender Cup Washers

BCW-51 All Zinc.....3.95 ea.

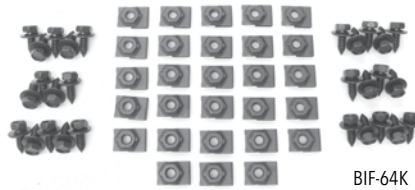

Fender Inner Bolt Kit To Fender

BIF-64K All (56 pc.).....26.95 ea.



Flywheel Attaching Kit

BPB-5116 All 4 Speed.....14.99 kit
 BPB-5118 All Auto.....16.99 kit



Front End Fastener Kit

Over 175 pieces individually bagged! Includes everything you need to assemble your front end!

BFE-9001 1967-68 All.....45.95 kit
 BFE-9002 1969 All.....45.95 kit
 BFE-9003 1970-81.....45.95 kit



Fuel Pump Bolts

ACE-4867 All.....7.95 kit

BCI-4753



Fuel Tank Attaching Kit

Complete with correct bolts, screws and washers and nuts.

BCI-4753 1967-69 All.....8.95 kit



Grille Attaching Kits

Basic service kit for replacing grille hardware.

BAG-DLX678

BAG-D3 1967-68 Bezel.....5.95 kit
 BAG-69Z 1969 Bezel.....5.95 kit
 BAG-DLX678 1967-68 All Grille & Bezel.....11.95 kit
 BAG-DLX69 1969 All Grille & Bezel.....12.95 kit
 BAG-703FS 1970-73 Standard Nose.....12.95 kit
 BAG-703FRS 1970-73 RS Nose.....14.95 kit
 BAG-747F 1974-77 Standard Nose.....12.95 kit
 BAG-746FZ 1974-76 Z/28 Nose.....12.95 kit
 BAG-77FZ 1977 Z/28 Nose.....14.95 kit
 BAG-78F 1978 Standard Nose.....15.95 kit
 BAG-78FZ 1978 Z/28 Nose.....15.95 kit
 BAG-79F 1979 Standard Nose.....14.95 kit
 BAG-79FZ 1979 Z/28 Nose.....14.95 kit



Harmonic Balancer Bolt

BPB-5933 All SB w/ Washer.....14.99 kit
 BPB-5934 All BB w/ Washer.....13.99 kit



Hood Adjustment Bolts

BPO-4011 1967-69.....9.95 kit
 BPO-4011-70-REAR 1970-81 Rear.....15.99 pr.
 BPO-4011-CNTR 1970-81 Rear Center.....17.99 kit



Eddie Motorsports Billet Hood Adjustment Bolts

MS275-38 5/16" Machined.....28.99 ea.
 MS275-38P 5/16" Polished.....29.99 ea.



Hood Hinge Bolt

BPA-381 3/8" x 1".....0.65 ea.

Intake Manifold Kits
Featuring correct flanged head bolts.

BPI-9140	SB "M" 12pc.....	16.95 kit
BPI-9140	BB Cast "M" 16pc.....	21.95 kit
BPI-2271	BB Alum. "A" 16pc.....	25.99 kit

Intake Studs

BPS-3679	3/8" x 3/8".....	6.99 ea.
BPS-7432	5/16" x 3/8".....	3.95 ea.

BPX-9873

Idle Arm Bolts

BPX-9873	To Frame.....	3.95 pr.
----------	---------------	----------

BCB-12955

1970-81 Hood Bumpers
Correct 13/16" height. Rubber with metal core.

BCB-12955	1970-81.....	18.95 pr.
-----------	--------------	-----------

BHE-1970

Jack/Tire Retainer Kit

BHE-1970	1967-81 All.....	9.95 set
----------	------------------	----------

BBB-2743

Leaf Spring Front Eye Bolt

BBB-2743	All.....	3.95 ea.
----------	----------	----------

Two required per car.

BLS-1130

Leaf Bracket Mounting Kit (to Body)

BLS-1130	1967-81 12pc.....	16.95 kit
----------	-------------------	-----------

BPA-53K

License Plate Attaching Kit

BPA-53K	All 4pc.....	3.95 kit
---------	--------------	----------

BPB-14

License Plate Bracket Mounting Kit

BPB-14	1967-68.....	4.95 kit
BPB-16	1969.....	4.95 kit

APB-9057

Motor Mount Thru Bolts

APB-9057	4-1/2".....	8.95 kit
APB-7057	3-1/2".....	6.95 kit

BSL-516

Nuts Self Locking

BSL-516	5/16" Zinc.....	0.40 ea.
BSL-38	3/8" Zinc.....	0.50 ea.
BSL-716	7/16" Zinc.....	0.75 ea.
BSL-12	1/2" Zinc.....	0.95 ea.

Oil Drain Bolt w/ Washer

BPO-1988	All.....	6.95 ea.
----------	----------	----------

Oil Pan Attaching Bolts
With correct head marked SEMS bolts.

BOP-2001	All SB.....	9.95 ea.
BOP-2002	All BB.....	13.99 ea.

BOP-2001

BOP-2002

Oil Pan Attaching Bolts
With correct head marked SEMS bolts.

BOP-2001	All SB.....	9.95 ea.
BOP-2002	All BB.....	13.99 ea.

BSB-1970

Power Steering Hardware Kits
Our kits feature all correct hardware to attach power steering brackets to engine. A MUST!

G-4804	1967 SB 302,350.....	15.99 kit
G-4805	1967 BB 396.....	15.99 kit
G-4917	1968 SB 302,350.....	15.99 kit
G-4918	1968 BB 396.....	15.99 kit
BSB-69SB	1969-74 SB All.....	11.99 kit
BSB-1969	1969 All BB.....	17.99 kit
BSB-1970	1970+ All BB.....	12.95 kit

BPP-12 BPP-34 BPP-10

Push In Plugs

BPP-12	1/2" Cowl Top, etc.....	0.75 ea.
BPP-34	3/4" Wheelhouse.....	1.00 ea.
BPP-10	1" Trunk Extension.....	1.25 ea.
BPP-138	1-3/8" Rubber Plug.....	1.50 ea.



BPP-8386

Pressure Plate Bolt Kit

BPP-8386 All 12pc.....9.99 kit



BFC-333

Pulley Attaching Bolts

BFC-333 All Fine 6pc.....6.95 kit
BRB-100 All Coarse 6pc.....6.95 kit



BRE-2008

Rear End Cover Bolt

BRE-2008 All Flanged.....0.95 ea.



BSB-56



BSB-561

Seat Belt Bolts

Correct shanked style seat belt bolts.

BSB-56 All Front Outer.....7.95 ea.
BSB-56 1967-68 Front Inner.....7.95 ea.
BSB-561 1969-72 Front Inner.....7.95 ea.
BSB-561 All Rear.....7.95 ea.
BSB-5-SBL 1967-81 No Shoulder *.....7.95 ea.

*Threaded all the way



BSM-516

Seat Mounting Bolts

BSM-516 All Front.....1.35 ea.
BSM-5NT All Rear.....1.35 ea.



BPX-1950

Sheet Metal Screw Kit

Over 20 pieces for small under hood items.

BPX-1950 All.....5.95 kit

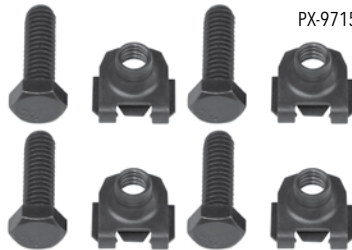

PX-9715

Shock Mounting Kit

Complete set of screws for lower front shocks.

BPX-9715 All.....6.95 kit



BPP-084

Rubber Body Plugs

BPP-084 1".....5.99 pr.
BPP-091 3/4".....2.99 ea.



BPP-092

Body Plug Kits

Correct with numerals and text embossing.

BPP-092 1967-68 12pc.....16.99 kit
BPP-093 1969 12pc.....26.99 kit



BV-2070

BV-2072

BV-2074

Starter Bolts

BV-2070 3/8" x 1 7/8" Short.....5.99 ea.
BV-2072 3/8" x 3 5/8" Long.....4.99 ea.
BV-2074 3/8" x 4 11/16" Extra Long.....5.99 ea.



BSB-757



BSB-759

Steering Box Bolt

BSB-757 1967-69.....3.95 ea.
BSB-759 1970-76.....6.99 ea.



ATR-1039



ATR-2039

Thermostat Housing

ATR-1039 Most SB Bolt/Stud.....7.95 ea.
ATR-2039 All SB-BB Bolt.....7.95 ea.
ATR-3039 1967-68 Gooseneck Z/28.....8.99 kit



BTC-650

Timing Cover Bolt Kit

BTC-650 "L" SEMS Bolts.....8.95 kit



BTE-307

Transmission Mounting Hardware

BTE-307 To Bellhousing 8pc..... 8.95 kit
 BTE-7939 To Rear Mount..... 0.95 ea.



BTE-7939



Trim Stud Repair Kit OE GM

OEM GM replacement trim studs for mounting front and rear window moldings and some rocker moldings. These studs come with a sealant to prevent corrosion.

KMC-15KWS 1967-92 All 8pc..... 18.99 kit



APB-1023 shown

Valve Cover Bolts

APB-1023 SB "TR" 16pc.....14.95 kit
 APB-2023 BB "TR" 28pc.....23.95 kit
 APB-1027 SB "M" 8pc.....16.99 kit
M bolts were used on finned aluminum valve covers.



ATR-3232



ATR-4334

Water Pump Attaching Kit

ATR-3232 1967-68.....8.99 kit
 ATR-4334 1969-81 M Mark.....10.99 kit



AWS-301S

Water Pump Studs

AWS-301S Short Pump..... 2.99 ea.
 AWS-302L Long Pump..... 3.95 ea.



AWX-818

Voltage Regulator

Well Nuts and Screws

AWX-818 1967-69 All.....6.95 kit



APX-1400

Wing Nuts

APX-1400 Chrome..... 4.95 ea.
 APX-7700 Black..... 4.95 ea.



67FA-F



AC On Engine Hardware

All the hardware related to the AC brackets on the engine.

66AA-SB 1967 SB32.99 kit
 67AA-SSB 1967 SB w/ Smog34.99 kit
 68FA-SB 1968 SB38.99 kit
 68FA-SB 1968 SB w/ Smog38.99 kit
 68FA-BB 1968 BB44.99 kit
 69AA-SB 1969 SB46.99 kit
 69AA-BB 1969 BB35.99 kit
 70AA-SB 1970 SB37.99 kit
 70AA-BB 1970-72 BB36.99 kit
 71AA-SB 1971 SB35.99 kit
 72AA-SB 1972-73 SB38.99 kit

AC Box Under Hood Hardware

All the hardware related to the A/C under the hood on the firewall forwards.

67FA-F 196743.99 kit
 68FA-F 196849.99 kit
 69FA-F 196959.99 kit
 70FA-F 197054.99 kit
 71FA-F 197147.99 kit
 72FA-F 197245.99 kit
 73FA-F 197349.99 kit

AC Box Under Dash Hardware

All the hardware related to the AC under the dash.

67FA-R 196739.99 kit
 68FA-R 196840.99 kit
 69FA-R 196944.99 kit
 70FA-R 197036.99 kit
 71FA-R 197133.99 kit
 72FA-R 1972-7338.99 kit

Engine Master Hardware Kits

The authentic hardware you need to correctly reassemble the engine components that attach to the long block. Typical kits include fasteners for: air cleaner, carburetor & choke cover, crank pulley & damper, distributor, exhaust manifold, exhaust pipe, engine fan, fuel pump plate & plug, heatsield, ignition coil & strap, intake manifold & plug, oil filter valve, oil pan, PCV adapter, PCV hose clamps, timing cover, valve covers, water neck, water pump.

67-Z28 1967-68 SB Z/28 174pc..... 109.99 kit
 66-SBS 1968 SB w/o AC 153pc 120.99 kit
 66-SBA 1968 SB w/ AC 164pc..... 114.99 kit
 68-BBH 1968 BB
 Aluminum Intake 149pc..... 126.99 kit
 68-BBS 1968 BB
 Cast Iron Intake 159pc..... 114.99 kit
 69-SB 1969-71 SB 170pc..... 114.99 kit
 69-Z28 1969 SB Z/28 162pc..... 108.99 kit
 69-BBH 1969-72 BB
 Aluminum Intake 14pc..... 124.99 kit
 69-BBS 1969-72 BB
 Cast Iron Intake 143pc..... 108.99 kit
 72-SB 1972-73 SB 139pc..... 115.99 kit
 72-Z28 1972-73 Z/28 145pc..... 111.99 kit

No Volume Discount



Window Molding Kits

This exclusive Ground Up window molding kit includes front windshield molding, rear window molding and all necessary installation clips at a special kit price!

KFX-67K	1967-69	235.27 kit
KXR-70FK	1970-74	289.62 kit
KXR-7074FKBLK	1970-74 All Black	314.95 ea.
KXR-70FKBLK	1975-81 All Black*	305.95 kit

*75-81 kit does not include clips



Front and Rear Window Molding Kits

Choose from either high quality reproduction moldings or our GM Restoration moldings which offer the best fit and finish on the market.

KFX-67R	1967-69 Coupe Front 5pc	119.95 kit
KFX-838	1967-69 Coupe Front 5pc	
	GM Restoration	194.95 kit
KFX-67V	1967-69 Convertible	
	Front 5pc	119.95 kit
	1970-81 All Front 5pc	119.95 kit
KXR-70F	1967-69 Coupe Rear 5pc	119.95 kit
KXR-67R	1967-69 Coupe Rear 5pc	
KFX-849	GM Restoration	195.95 kit
	1970-74 All Rear 5pc	179.95 kit
KXR-70R	1970-81 All Front Black	179.95 kit
KXR-70FBLK	1970-74 All Rear Black	169.99 kit
KXR-70RBLK	1975-81 All Rear 4pc	139.95 kit
KXR-75R	1975-81 Z/28 Black Rear 4pc	159.99 kit

All window moldings ship Oversize and well protected.



LWT-1073H

Wiper Motor Transmission Arm

OE style reproduction of the often missing arm.

LWT-1072C	1967	99.95 ea.
LWT-1072	1968-69	95.95 ea.
LWT-1073H	1970-73 w/o Hidden Wipers	109.95 ea.
FMP-CLIP	1967-81 Clip	4.95 ea.



Windshield Molding Clips

KMC-67KITF

Complete set of clips for one car.

KMC-67KITF	1967-69 Upper/Side	9.95 kit
KMC-79K	1967-69 Lower	16.95 kit
KMC-0069	1970-81	9.95 kit



Rear Window Molding Clips

KMC-67KITR

Complete set of clips for one car.

KMC-67KITR	1967-69 All	9.99 kit
KMC-0070	1970-74 All	11.95 kit
KMC-0211	1975-79 All	11.95 kit



KW-648

Windshield Glass Stops

OE style reproduction windshield glass stop clip, rubber coated as original.

KW-648	1967-69	6.99 ea.
KW-995	1970-81	12.99 ea.

BUY 'N SAVE WITH KITS



1967-69 Wiper Arm/Blade Kit

WIPERKIT-15

Complete kit with (2) arms and (2) blades.

WIPERKIT-15	1967-69 Coupe	55.35 kit
WIPERKIT-15B	1967-69 Coupe	55.35 kit
WIPERKIT-15V	1967-69 Convrt	55.35 kit
WIPERKIT-15VB	1967-69 Convrt	55.35 kit



1970-81 Wiper Arm/Blade Kit

Complete kit with (2) arms and (2) blades.

LWA-70KB	1970-81 Black	94.95 kit
LWA-70KS	1970-81 Brushed	94.95 kit



LWA-69B

LWA-69V

1967-69 Windshield Wiper Arms

LWA-647	1967-69 Coupe Polished	19.95 ea.
LWA-69B	1967-69 Coupe Satin	19.95 ea.
LWA-69V	1967-69 Convrt Polished	19.95 ea.
LWA-69VB	1967-69 Convrt Satin	19.95 ea.



LWB-64

Wiper Blades

New polished stainless steel and satin blades.

LWB-64	1967-69 Stainless 15"	16.95 ea.
LWB-72	1970-81 Stainless 16"	16.95 ea.
LWB-70FB	1970-81 Black 18"	18.95 ea.
LWB-70FS	1970-81 Silver Brushed 18"	18.95 ea.



KMC-15KWS

Trim Stud Repair Kit OE GM

OEM GM replacement trim studs for mounting front and rear window moldings and some rocker moldings. These studs come with a sealant to prevent corrosion.

KMC-15KWS	1967-92 All 8pc	18.99 kit
-----------	-----------------	-----------

Window Molding Stud/Pin Kit

Self tapping screws replace the original body studs used to retain factory window or vinyl top molding clips.

KMC-15	All 12pc	3.50 kit
--------	----------	----------



KDX-67R



Roof Drip Molding Kits

Beautiful stainless steel complete reproduction drip rail molding kits.

KDX-67R	1967-69 Reproduction 6pc.....	84.95 kit
KDX-67G	1967-69 GM Restoration 6pc.....	119.95 kit
KDX-70R	1970-81 Stainless.....	199.99 kit
KDX-71L	1971-78 Mylar w/o Vinyl Top LH...	47.99 ea.
KDX-71R	1971-78 Mylar w/o Vinyl Top RH...	47.99 ea.
KDX-71VL	1971-78 Mylar w/ Vinyl Top LH.....	57.99 ea.
KDX-71VR	1971-78 Mylar w/ Vinyl Top RH.....	57.99 ea.

All roof drip moldings ship Oversize and well protected.



RRC-69

Roof Weatherstrip Channel Set

This excellent quality roof weatherstrip channel is produced in a high luster stainless steel material just as the original! This often damaged piece bolts into the roof channel of the car and is used to retain the roof rail weatherstripping. This 6 piece kit even includes the correct blow out clips for the door glass.

RRC-67F	1967 All 6pc.....	199.95 kit
RRC-69	1968-69 All 6pc.....	199.95 kit

Roof drip moldings ship Oversize and well protected.



KPM-739

1967 Door Pillar Molding

OE style reproduction chrome pillar moldings which install on the doors. Constructed of heavyweight cast material with high quality chrome finish.

KPM-739	1967 All	232.99 pr.
---------	----------------	------------

Ships Oversize.



KBC-731

Roof Rail Blowout Clips

These rubber dipped spring steel clips retain the roof rail weatherstrip to the pillar and roof stainless trim. Includes correct clips to do one car.

KBC-731	1967-69 All	18.99 kit
KBC-973	1970-81 All	16.99 pr.



KRP-756

1970-81 Vertical Roof Moldings

Heavy chrome plated and polished moldings which install vertically between the door glass and quarter panel.

KRP-756	1970-81	49.99 pr.
---------	---------------	-----------



KVF-67L

KVF-67R



IVH-741

IVH-742



KVF-RVT

RWV-180

RWV-032A

Vent Window Frames & Hardware

Accurate reproduction of 67 Camaro vent window frames. Die stamped steel. Hard chrome plated as original.

KVF-67FL	1967 Vent Window Frame LH.....	58.99 ea.
KVF-67FR	1967 Vent Window Frame RH.....	58.99 ea.
RWV-032A	1967 Glass Frame Hardware	13.99 kit
KVF-RVT	1967 Vent Window Rivet	1.95 ea.
RWV-180	1967 Vent Window Hardware.....	12.99 kit
RWV-184	1967 Assembly Studs	12.99 pr.
IVH-741	1967 Pivot Stud Assembly	20.99 kit
IVH-742	1967 Pivot Stud Nut	5.99 ea.



KW-1041

Convertible Well Molding

OE style reproduction of the rear body "pinch weld" molding in polished stainless steel as original.

KW-1041	1967-69	139.95 set
LMC-3640	1967-69 Clips	39.95 set

No Volume Discount. Ships Oversize.



KQ-177

KQ-39

Convertible Header Molding

OE style reproduction header moldings in either chrome for 1967 models or satin for 1968-69 models. Both are interchangeable.

KQ-177	1967 Polished Chrome	139.99 pr.
KQ-39	1968-69 Satin	144.99 pr.
KQB-33	Screw Kit	4.99 kit



Vinyl Tops

Reproduction style double seamed padded tops.

VT-69BLK	1967-69 Black.....	172.99 ea.
VT-69WHT	1967-69 White.....	172.99 ea.
VT-70BLK	1970-81 Black.....	172.99 ea.

Vinyl Tops OEM

Factory correct non-padded vinyl tops with the correct reverse OE style stitching for the purist.

VT-TT52-B	1967-69 Black.....	219.95 ea.
VT-TT52-W	1967-69 White.....	219.95 ea.

Vinyl Top Molding Sets

OE style reproduction vinyl top molding sets with correct cast and stainless pieces.

K-863	1967-68 2pc	134.99 set
K-653	1969 4pc.....	138.99 set
K863C	1967-68 All Clips Only.....	20.99 kit
K653C	1969 All Clips Only	16.99 kit



K-653



Convertible Pillar Moldings KPL-68R
Correct polished stainless steel as original.

KPL-68L	1967-69 LH.....	54.99 ea.
KPL-68R	1967-69 RH.....	54.99 ea.



KQL-280

1969 Quarter Louvers

New die cast chrome moldings with correct semi-gloss black accenting. Choose from imported reproduction or USA made Trim Parts brand.

KQL-280	1969 Repro.....	59.95 pr.
KQL-6776	1969 Trim Parts Brand*.....	72.95 pr.
CT-725	Mounting Template.....	16.99 ea.

*Made in the USA



MPX-6967

Door Handle Kits

Complete kit with (2) door handles, (1) gasket set, and (1) push button set.

MPX-6967	1967-69 All.....	44.95 kit
MEH-4551	Gaskets Only.....	3.95 kit



MPX-6735



Door Handles OE Style

High quality with hardware made exclusively by Trim Parts. Fit and function as original. Highest quality on the market. Replaces GM 5716870.

MPX-6735	1967-69 OE High Quality.....	69.99 pr.
----------	------------------------------	-----------



MS277-10

Eddie Motorsports Billet Door Handles

M = Machined, P = Polished, R = Red Fusioncoat, B = Blue Fusioncoat, W = White Fusioncoat, PR = Purple Fusioncoat, BK = Gloss Black Fusioncoat, BKA = Gloss Black Anodized, MB = Matte Black Fusioncoat, MBA = Matte Black Finish, CL = Clear Coat, CA = Clear Anodized

		M,P	All Others
MS277-10_	1967-69		
	Billet Door Handles....	305.99 pr.	321.99 pr.



MEH-254K

1970-81 Door Handles

OE style reproduction chrome door handles. Buy the kit and save! Gaskets not included.

MEH-252L	1970-74 LH (6-1/4" long).....	34.99 ea.
MEH-252R	1970-74 RH (6-1/4" long).....	34.99 ea.
MEH-252K	1970-74 Kit (6-1/4" long).....	62.98 kit
MEH-254L	1970-81 LH (5-1/2" long).....	15.95 ea.
MEH-254R	1970-81 RH (5-1/2" long).....	15.95 ea.
MEH-254K	1970-81 Kit (5-1/2" long).....	26.80 kit
MEH-551	Gasket Only.....	6.95 ea.

Notes: On GM factory cars 70-74 handles are 6-1/4" long, 75-81 handles are 5-1/2" long.

MCC-5255



Door Handle Push Buttons

This is a complete door handle push button kit. This kit includes (2) buttons, (2) rubber rings, (2) springs and (2) retainers for a complete replacement.

MCC-5255	1967-69 All.....	18.95 kit
----------	------------------	-----------



ANT-01

Antenna Kits

Our kits come complete with correct cable, antenna base, gasket and mast.

ANT-01	1967-68 Front AM/FM Fixed Mast.....	42.95 kit
ANT-0026	1969 Front AM/FM Fixed Mast.....	42.95 kit
ANT-0045	1967-68 Front AM Telescoping Mast.....	189.95 kit
ANT-0046	1969 Front AM Telescoping Mast.....	189.95 kit
ANT-0047	1967-68 Rear AM Semi Telescoping..	189.95 kit
ANT-0047FM	1967-68 Rear AM/FM Fixed Mast.....	44.95 ea.
ANT-0048	1969 Rear AM Semi Telescoping.....	189.95 kit
ANT-69AMOE	1969 Mast Only.....	58.99 ea.
ANT-0048FM	1969 Rear AM/FM Fixed Mast.....	44.95 ea.
CT-728	1967-68 Front Antenna Mounting Template.....	8.99 ea.
CT-729	1969 Front Antenna Mounting Template.....	8.99 ea.
CT-726	1967-69 Rear Antenna Mounting Template.....	8.99 ea.

ANT-RFF29

ANT-RFF29A

ANT-678FRM



Antenna Bezel

The correct bezel for rear mounted antennas.

ANT-678FRM	1967-68.....	14.95 ea.
ANT-RFF29	1969 Bezel.....	15.95 ea.
ANT-RFF29A	1969 Plate.....	12.95 ea.

REAR VIEW MIRRORS



MRR-68

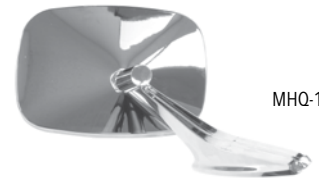

MHQ-1316L



MHQ-3171

Rear View Mirrors

OE style reproduction, triple chrome plated rear view mirror. There are many different mirrors on the market, but these are tried and true. We use them on our own cars!

MHQ-3171	1967-68 Bowtie All.....	29.95 ea.
MRR-68	1967-68 w/o Bowtie.....	24.95 ea.
MHQ-1316L	1968-69 LH.....	24.95 ea.
MHQ-1316R	1968-69 RH.....	24.95 ea.
M-1036	1970-81 LH or RH.....	35.95 ea.



MHQ-3171-PQ



MHQ-1316L-PQ

1967-69 Premium Outside Mirrors

Round Premium Mirror

Premium upgrade mirror. Features correct rib line on top of the base. Will not droop like aftermarket mirrors.

MHQ-3171-PQ	1967-69.....	49.95 ea.
-------------	--------------	-----------

Square Premium Mirror

Premium upgrade mirror. Features correct rib line on top of the base. Will not droop like aftermarket mirrors.

MHQ-1316R-PQ	1967-69 RH.....	49.95 ea.
MHQ-1316L-PQ	1967-69 LH.....	49.95 ea.

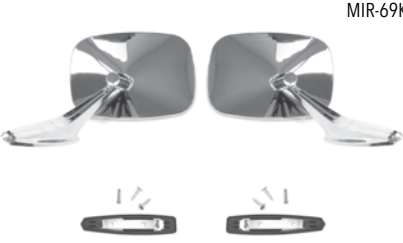

MIR-69K

Mirror Kits
Complete kit with (2) rear view mirrors and (2) mirror mounting kits.

EXCLUSIVE
GROUND UP PRODUCTION

MIR-71K	1967-68 Bowtie	52.35 kit
MIR-88K	1967-68 w/o Bowtie	44.85 kit
MIR-69K	1968-69 Rectangle	44.85 kit



MHQ-1234

814441

Mirror Mounting Kits
Complete with bracket, gasket and screws.

MHQ-1234	1967-69 w/o Remote	4.95 kit
814441	1970-81 Std Bracket	12.99 ea.
9816863	1970-81 Std Gasket	8.99 ea.



EMG-231

Bullet Mirror Glass
Replacement glass for bullet style mirrors

EMG-231	1970-81 LH	23.99 ea.
EMG-156	1970-81 RH	23.99 ea.

Note: Does not include lettering on glass.



20055804

Bullet Mirror Hardware
Correct brackets and gasket for mounting your 1970-81 bullet style mirrors.

20055839	1970-81 Bracket RH	11.99 ea.
20055804	1970-81 Bracket LH	13.99 ea.
9832129	1970-81 Gasket	4.99 ea.



MK-907

1967 Remote Rear View Mirror
OE style reproduction of the ultra rare remote rear view mirror featuring the correct length cable, interior chrome bezel, mounting kit and highly polished triple chrome finish.

MK-907 1967 All 164.99 ea.
No Volume Discount



3921816

1968 Remote Rear View Mirror
OE style reproduction of the ultra rare remote rear view mirror featuring the correct length cable, mounting kit and highly polished triple chrome finish.

3921816	1968 All	141.99 ea.
IMB-833	1968 Bezel Std. Interior	29.99 ea.
IMB-450	1968 Bezel Dlx. Interior	29.99 ea.

No Volume Discount



3957203

1969 Remote Rear View Mirror
OE style reproduction of the ultra rare remote rear view mirror featuring the correct length cable, mounting kit and highly polished triple chrome finish.

3957203	1969 All	141.99 ea.
IMB-833	1969 Bezel Std. Interior	29.99 ea.
IMB-450	1969 Bezel Dlx Interior	29.99 ea.

No Volume Discount



MK-801

1970-81 Bullet Mirrors
OE style reproduction of the original die cast bullet style mirrors. The driver side mirror is remote adjustable and includes a pre-installed cable. The passenger mirror is non-remote and is manually adjustable.

MK-801	1970-81 LH	159.99 ea.
MK-908	1970-81 RH	129.99 ea.

No Volume Discount



KRP-79

KRP-1012 • 1970-81 Narrow

KRP-70L • 1970-75 Wide LH

Standard Rocker Panel Moldings
Excellent reproduction rocker panel moldings manufactured to exact OE thickness. Mounting hardware is included. Choose from regular reproduction style or GM licensed reproduction.

KRP-79	1967-69 Reproduction	21.95 ea.
KRP-765GM	1967-69 GM Restoration	49.99 ea.
KRP-1012	1970-81 Narrow	24.95 ea.
KRC-031	1970-81 Clip for Narrow Molding	3.99 ea.
KRP-70L	1970-75 Wide LH	89.99 ea.
KRP-70R	1970-75 Wide RH	89.99 ea.

Ships Oversize.



KMX-478

Rally Sport Rocker Panel Moldings
Highly polished anodized aluminum lower body moldings. This 6 piece kit does one car. Mounting hardware sold separately.

KMX-452	1967 Rally Sport 6pc	159.99 ea.
KMX-478	1968 Rally Sport 6pc	150.99 ea.
KCX-453	1967 Mounting Hardware	28.99 kit
KCX-101	1968 Mounting Hardware	29.99 kit
CT-704	1967 Molding Mounting Template	23.99 ea.
CT-711	1968 Molding Mounting Template	21.99 ea.

Ships Oversize.



KMX-L9192

Z/28 Lower Door Extensions
Manufactured in fiberglass, this reproduction features the correct mounting points and is ideal to replace missing or damaged door extensions or for use to convert a standard Camaro into a Z/28 with some minor mounting modifications.

KMX-L8590	1985-90 Z/28	261.99 pr.
KMX-L9192	1991-92 Z/28	276.99 pr.



KL-257 Detail

Door Ledge Moldings
OE style reproduction of the special 1-1/2" molding installed on some specially optioned 1968 Camaros. These moldings can be installed on all 1968 Camaros as an upgrade.

KL-257	1968 Door	95.99 pr.
KL-262	1968 Quarter Ledge Coupe	84.99 pr.
KL-263	1968 Quarter Ledge Convertible	84.99 pr.

Ships Oversize.



KW-67R

Wheel Opening Moldings

OE style reproduction stainless moldings sold in sets of four.

KW-67R	1967-68 All	69.95 set
KW-68R	1968 RS	69.95 set
KW-69R	1969 All	69.95 set

Ships Oversize. No Volume Discount.



KW-69GM

GM Restoration Wheel Opening Moldings

GM Restoration wheel opening moldings OE gauge, excellent fit. Superior workmanship eliminates the scratched and dented appearance of lesser quality imported sets. Officially Licensed GM Restoration Parts. Includes screws.

KW-67GM	1967-68	173.99 kit
KW-69GM	1969	173.99 kit



KQW-996

Quarter Window Molding

Our triple chrome moldings come complete with correct rubber seals which seal the glass to the chrome.

KQW-996	1967-69	79.99 pr.
---------	---------	-----------



JSS-3022

Quarter Glass Seals

Correct rubber seal which slides into the quarter window and seals the front and rear windows. Features steel core with rubber coating as factory.

JSS-3022	1967-69	18.95 pr.
----------	---------	-----------



KE-1020

Door Edge Guard

OE style reproduction door edge guards.

KE-1020	1967-68	19.95 pr.
KE-1022	1969	19.95 pr.
KE-1024	1970-81	16.95 pr.



KR-679

1970-81 Optional Exterior Moldings

The moldings in this set make up the optional exterior molding package available on 1970-81 Camaros. This set includes (2) door reveal moldings, (2) front fender corner edge moldings and (1) rear of hood molding. All moldings are available individually.

KR-679	1970-81 Complete 5pc	190.77 kit
KR-677	1970-81 Hood & Corner Moldings 3pc	99.99 kit
KDM-343	Door Reveal Molding RH	55.99 ea.
KDM-344	Door Reveal Molding LH	55.99 ea.



KVS-774

1970-81 Cowl Vent Screen

Injection molded plastic screen which mounts to the top of the upper cowl area on all models.

KVS-774	1970-81 All	59.99 ea.
---------	-------------	-----------



NR-46

1967 SS Hood Ornaments

Manufactured with new high quality tooling. These high quality reproduction hood louver ornaments feature the correct chrome raised fins on a semi flat black background.

NR-46	1967 Hood Ornaments	94.95 pr.
KHB-S	1967 Correct Hood Seals	11.99 pr.



NW-476



KLD-3974

1968-69 SS Hood Ornament Kit

This complete 1968-69 Camaro SS hood ornament kit comes with (2) "stacked" louvers and (2) bezels to give your SS hood that finishing touch. Drains sold separately. (Drains are for original GM hoods only.)

NW-476	1968-69 Ornament Kit	149.99 pr.
KLD-3974	1968-69 Drains	12.99 pr.



MHQ-0337

1967-69 Front Spoiler

Quality reproduction ABS plastic front spoilers which were originally used by the factory to aid in aerodynamic performance.

MHQ-0336	1967-68 Spoiler	25.95 ea.
MHQ-0337	1969 Spoiler	25.95 ea.
MHQ-221	1967-69 Brackets	14.95 kit
MB-703	1967-69 Hardware	6.95 kit

Ships Oversize.



MSK-69F

1967-69 Front Spoiler Kit

Complete front spoiler kit including a correct ABS plastic front spoiler, bracket set and attaching hardware.

MSK-67F	1967-68 All	40.67 kit
MSK-69F	1969 All	40.67 kit

Ships Oversize.



MFS-70R

1970-73 Front Spoiler

Injection molded front spoiler which attaches directly to the lower valance panel.

MFS-70	1970-73 Standard	99.99 ea.
MFS-70R	1970-73 Rally Sport	99.99 ea.
MB-70F	1970-73 Hardware	11.95 kit

Ships Oversized.



MFS-747

1974-77 Front Spoiler

Brand new injection molded front spoiler as original. Includes center, left and right pieces.

MFS-747	1974-77	199.95 kit
---------	---------	------------



MFS-253

1978-81 Front Spoiler & Fender Flares

Reproduction spoiler kit and flare kits complete with welting set. Made of durable high quality urethane as original.

MFS-253	1978-81 Front Spoiler & Flares	329.99 kit
MFS-270	1978-81 Rear Flares	199.99 kit

Note: Rear flares original for 1980-1981 only but can be used on 1978-1979.



MSW-047

Welting Set

This welting can generally be used on all GM vehicles with ground effects, flares or spoilers. Includes 15 feet of welting. Cut to desired length.

MSW-047	1978-81	29.99 kit
---------	---------	-----------

GRILLE KITS

BUY'N SAVE
WITH KITS



GRILLE-67S

1967 Standard Grille Kit

This is a complete grille kit for your 1967 standard Camaro. It includes (1) grille, (2) headlamp bezels, (1) upper grille molding and (1) lower grille molding.

GRILLE-67S 1967 Standard227.59 kit
No Volume Discount.

BUY'N SAVE
WITH KITS



GRILLE-68S

1968 Standard Grille Kit

This is a complete grille kit for your 1968 standard Camaro. It includes (1) grille, (2) headlamp bezels, (1) upper grille molding and (1) lower grille molding.

GRILLE-68S 1968 Standard248.29 kit
No Volume Discount.

BUY'N SAVE
WITH KITS

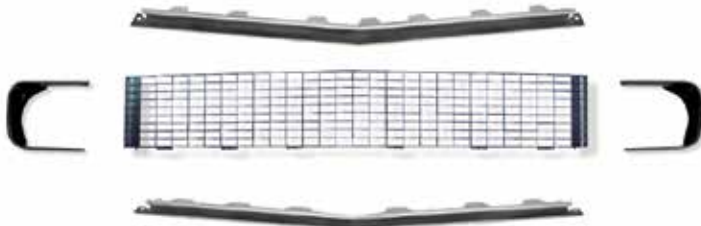

GRILLE-78R

1967-68 Rally Sport Grille Kit

This is a complete grille kit for your 1967-68 Camaro Rally Sport. It includes (1) grille, (1) upper grille molding, (1) lower grille molding and (2) headlamp bezels. Choose with or without chrome trim. 1967 was originally black and 1968 originally had chrome trim.

GRILLE-78R 1967-68 RS w/o Trim233.93 kit
GRILLE-88R 1967-68 RS w/ Trim260.93 kit
No Volume Discount. Ships Oversize.



GRILLE-69SB

BUY'N SAVE
WITH KITS

1969 Standard Grille Kit

This is a complete grille kit for your 1969 standard Camaro. It includes (1) grille, (2) headlamp bezels and (1) upper grille reinforcement.

GRILLE-69SB 1969 Standard Black251.94 kit
GRILLE-69SS 1969 Standard Silver251.97 kit
No Volume Discount. Ships Oversize.



GRILLE-69RS

BUY'N SAVE
WITH KITS

1969 Rally Sport Grille Kit

This is a complete grille kit for your 1969 Camaro Rally Sport. It includes (1) grille, (1) grille molding and (1) upper grille reinforcement.

GRILLE-69RS 1969 RS246.44 kit
No Volume Discount. Ships Oversize.

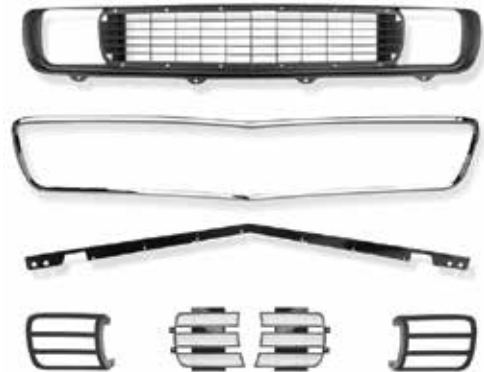

GRILLE-69UP

BUY'N SAVE
WITH KITS

1969 Rally Sport Grille Kit W/ Headlight Doors

This is a complete 1969 Camaro Rally Sport grille kit which includes (1) grille, (1) grille molding, (1) upper grille stiffener, (2) chrome inner headlight doors and (2) paintable outer headlight doors.

GRILLE-69UP 1969 RS Complete Kit385.11 kit
No Volume Discount. Ships Oversize.

GRILLES

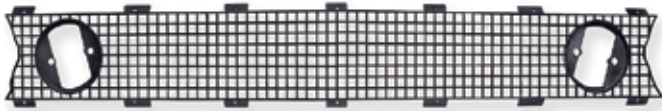

LEH-1693R

1967 Standard Grille

This is an OE style reproduction standard grille manufactured from all new tooling.

LEH-1693R 1967 Standard 62.95 ea.



LEH-4772R

1968 Standard Grille

This is an OE style reproduction standard grille assembly which will replace your cracked or damaged original.

LEH-4772R 1968 Standard 89.95 ea.
LMB-695 1968 Mounting Brackets w/ Rivets 16.99 pr.

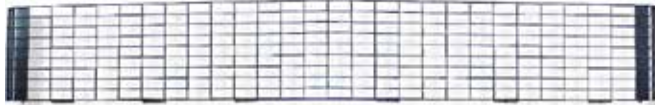

LEH-9060R



3919060C

1967-68 Rally Sport Grille

This is an OE style reproduction Rally Sport grille assembly available in black for 1967 Camaro and black with chrome trim for 1968 Camaros. Both are interchangeable.

LEH-9060R 1967-68 RS Black 49.95 ea.
3919060C 1967-68 Black w/ Chrome Trim 79.95 ea.



LEH-7062R



LEH-7062S

1969 Standard Grille

This is an OE style reproduction standard grille which features the correct chrome trim. Choose from black or silver.

LEH-7062R 1969 Standard Black 149.95 ea.
LEH-7062S 1969 Standard Silver 149.99 ea.
Ships Oversized.



LEH-8641R

1969 Rally Sport Grille

This is an OE style reproduction Rally Sport grille which features the correct black finish.

LEH-8641R 1969 Rally Sport 139.95 ea.
Ships Oversize.



LEH-516



LEH-64JA

1970-73 Standard Grille

This is an OE style reproduction standard grille manufactured from all new tooling. Available in silver or black for Z/28.

LEH-516 1970-71 Standard Silver 149.95 ea.
LEH-517 1970-71 Standard Black 149.95 ea.
LEH-64J 1972-73 Standard Silver 99.95 ea.
LEH-64JA 1972-73 Standard Black 149.95 ea.



LEH-1064

1970-73 Rally Sport Grilles

OE style reproduction Rally Sport grilles manufactured in black. Sold as a matched pair.

LEH-1064 1970-73 RS 139.99 ea.



MCI-9447

LK-899



1970-73 Rally Sport Nose & Bezel

Correct urethane and chrome bezel for 1970-73 Rally Sport.

MCI-9447 1970-73 RS Nose 494.99 ea.
LK-899 1970-73 RS Chrome Bezel 417.99 ea.



1970-73 Rally Sport Divider & Bracket

OE style reproduction Rally Sport divider bracket and insert which install between the LH and RH grilles.

MK-55	1970-73 RS Divider Bracket.....	39.99 ea.
MK-57	1970-73 RS Rubber Insert.....	24.99 ea.



Billet Grilles, 1967-69 Standard

Installing a custom billet grille is an easy way to make your car really stand out at shows, cruise ins and while driving around town. Made from high polished 6061-T6 aluminum.

LEH-B102	1967 w/ Park Lamp Holes Replacement.....	139.95 ea.
LEH-B103	1967 w/o Park Lamp Holes Replacement.....	139.95 ea.
LEH-B114	1968 Layover.....	139.95 ea.
LEH-B107	1969 Layover.....	179.95 ea.
LEH-B110	1969 Full Replacement (Covers Headlights)*.....	199.95 ea.

Billet Grilles, 1967-69 Rally Sport

LEH-B101	1967-68 Replacement w/ Doors.....	179.95 ea.
LEH-B112	1969 Layover Center Grille (w/o RS Molding).....	149.95 ea.
LEH-B113	1969 Layover Center Grille (w/ RS Molding).....	149.95 ea.
LEH-B111	1969 Full Layover (Covers Headlights)*.....	179.95 ea.

Billet Grilles, 1970-81

LEH-B108	1970-73 Std. Replacement.....	129.95 ea.
LEH-B79RS	1970-73 RS Replacement.....	169.95 set
LEH-B80	1974-77 Replacement Upper & Lower.....	159.95 set
LEH-B78	1978-79 Replacement Upper & Lower.....	164.95 set
LEH-B79	1980-81 Replacement Upper & Lower.....	164.95 set

Note: Layover = Mounts over existing grille.
Replacement = Complete replacement of factory grille.
*Off road use only.



1974-77 Upper Grilles

OE style reproduction upper grilles in your choice of black or gray.

LEH-060	1974-77 Gray.....	24.95 ea.
LEH-061	1974-77 Z/28 Black.....	24.95 ea.



1974-77 Lower Grilles

Correct reproduction lower grilles in your choice of black or gray.

LEH-162	1974-77 Gray.....	74.99 ea.
LEH-163	1974-77 Black.....	74.99 ea.



1978-81 Grilles

OE style reproduction upper grilles in your choice of black for Z/28 or gray for standard.

LEH-062	1978-79 Gray.....	24.95 ea.
LEH-063	1978-79 Z/28 Black.....	19.95 ea.
LEH-064	1980-81 Gray.....	19.95 ea.
LEH-064A	1980-81 Z/28 Black.....	49.95 ea.



1978-79 Lower Grilles

OE style reproduction lower grilles in your choice of black for Z/28 or gray for standard.

LEH-170	1978-79 Gray.....	83.99 ea.
LEH-36	1978-79 Z/28 Black.....	83.99 ea.



1987-92 Grille

Correct reproduction lower grilles in black.

4022-050-871	1987-92 RS.....	29.95 ea.
4022-050-871	1988-90 Z/28, IROC*.....	29.95 ea.

*For cars without fog lamps.



Grille Attaching Kits

Basic service kit for replacing grille hardware.

BAG-D3	1967-68 Bezel.....	5.95 kit
BAG-69Z	1969 Bezel.....	5.95 kit
BAG-DLX678	1967-68 All Grille & Bezel.....	11.95 kit
BAG-DLX69	1969 All Grille & Bezel.....	12.95 kit
BAG-703FS	1970-73 Standard Nose.....	12.95 kit
BAG-703FRS	1970-73 RS Nose.....	14.95 kit
BAG-747F	1974-77 Standard Nose.....	12.95 kit
BAG-746FZ	1974-76 Z/28 Nose.....	12.95 kit
BAG-77FZ	1977 Z/28 Nose.....	14.95 kit
BAG-78F	1978 Standard Nose.....	15.95 kit
BAG-78FZ	1978 Z/28 Nose.....	15.95 kit
BAG-79F	1979 Standard Nose.....	14.95 kit
BAG-79FZ	1979 Z/28 Nose.....	14.95 kit



1967 Standard Grille Moldings

OE style reproduction stamped aluminum grille moldings with correct accenting for standard grilles.

LEH-1691	1967 Standard Upper.....	59.95 ea.
LEH-1692	1967 Standard Lower.....	59.99 ea.



1968 Standard Grille Moldings

OE style reproduction stamped aluminum grille moldings with correct accenting for standard grilles.

LEH-4771	1968 Standard Upper.....	59.99 ea.
LEH-4773	1968 Standard Lower.....	55.95 ea.



1967-68 Rally Sport Grille Moldings

OE style reproduction stamped aluminum grille moldings with correct accenting for Rally Sport grilles.

LHQ-1413	1967-68 Rally Sport Upper.....	64.99 ea.
LHQ-1414	1967-68 Rally Sport Lower.....	64.99 ea.



1969 Rally Sport Grille Molding

Correct die cast molding installed on all 1969 Camaros with Rally Sport option.

LEH-8637	1969 Rally Sport.....	119.99 ea.
----------	-----------------------	------------

Ships Oversize.



1969 Grille Stiffener

Correct grille stiffener which is inserted between the top of the grille and the header panel and acts as a trim piece to fill the gap.

LKO-69	1969 All.....	29.99 ea.
--------	---------------	-----------

Ships Oversize.



LHX-151

1967 Standard Headlamp Bezel Kit

OE style reproduction headlamp bezels with correct accenting.

LHX-151 1967 Standard..... 69.99 pr.
No Volume Discount



LHX-770

1968 Standard Headlamp Bezel Kit

OE style reproduction aluminum headlamp bezels with correct flat black paint.

LHX-770 1968 Standard..... 69.99 pr.
No Volume Discount



LHX-901

1969 Standard Headlamp Bezel Kit

OE style reproduction headlamp bezels including the correct chrome trim for the optional exterior decor package. Chrome can be removed for standard trim package.

LHX-901 1969 Standard..... 99.99 pr.
No Volume Discount

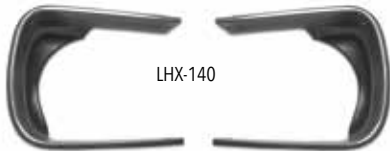

LHX-140

1967-68 RS Headlamp Bezel Kit

OE style reproduction aluminum headlamp bezels with correct paint.

LHX-140 1967-68 Rally Sport..... 79.99 pr.
No Volume Discount



BAG-D3

Headlamp Bezel Attaching Kit

Basic set of screws and clips to attach headlamp bezels.

BAG-D3 1967-68 All.....5.95 kit
BAG-69Z 1969 All.....5.95 kit



LHX-BN

1967-68 Headlamp Bezel Nuts

Correct hardware for attaching the bezels.

LHX-BN 1967-68 8pc.....6.99 kit



LHB-044

1970-73 Headlamp Bezel Kit

OE style reproduction headlamp bezels constructed out of correct aluminum. These can be mounted on standard or RS front ends.

LHB-044 1970-73 All..... 79.99 pr.
No Volume Discount



LHB-791

LHB-792



LHB-796

LHB-797

1974-77 Headlamp Bezels

OE style reproduction headlamp bezels for Rally Sport and Z/28 Camaros. The RS bezels feature a polished rim and brushed reflector and the Z/28 bezels feature a polished rim and black reflector.

LHB-792 1974-77 RS RH.....64.99 ea.
LHB-791 1974-77 RS LH.....64.99 ea.
LHB-797 1974-77 Z/28 RH.....64.99 ea.
LHB-796 1974-77 Z/28 LH.....64.99 ea.



LHB-577



LHB-032

1978-81 Headlamp Bezels

OE style reproduction bezels for standard and Z/28 Camaros. The standard bezels are chrome and the Z/28 bezels are black.

LHB-578 1978-81 RS RH.....64.99 ea.
LHB-577 1978-81 RS LH.....64.99 ea.
LHB-032 1978-81 Z/28 RH.....51.99 ea.
LHB-031 1978-81 Z/28 LH.....51.99 ea.



LPH-153

LPH-154



LPH-033

LPH-034

1978-81 Parking Lamp Bezels

OE style reproduction parking lamp bezels for standard and Z/28 Camaros. The standard bezels are chrome and the Z/28 bezels are black.

LPH-154 1978-81 Chrome RH.....38.99 ea.
LPH-153 1978-81 Chrome LH.....38.99 ea.
LPH-034 1978-81 Black RH.....32.99 ea.
LPH-033 1978-81 Black LH.....32.99 ea.



HLP-882 (Front View)



HLP-882 (Top View)

1982-92 Headlamp Mounting Panel

HLP-882 1982-92 All.....69.99 ea.



LBC-305

1978-81 Front Nose/Bumper Cover

Available in OEM style urethane for the purist.

LBC-305 1978-81 Urethane.....694.99 ea.
No Volume Discount. This item ships truck freight.



LBC-306

1978-81 Rear Bumper Cover

Available in OEM style urethane for the purist.

LBC-306 1978-81 Urethane.....480.99 ea.
No Volume Discount. Oversize 2.



1967-69 Chrome Bumper Kits

Nothing will freshen up your Camaro more than a new set of front and rear bumpers! These bumpers are triple chrome plated for a beautiful shine. Each kit includes (1) front bumper, (1) rear bumper and a set of correct bumper bolts. All at a special kit price!

MKY-67K	1967 All	193.37 kit
MKY-68K	1968 All	193.37 kit
MKY-69K	1969 All	193.37 kit
MKY-70K	1970-73 Standard	295.67 kit
MKY-70RK	1970-73 Rally Sport	286.36 kit

Oversize 2.



Ground Up Premium Bumpers

These Ground Up exclusive premium bumpers feature triple chrome plating with less wrinkled edges and heavy OEM gauge steel for the ultimate in authenticity. Rears include the center support riveted in. This is by far the best bumper on the market.

MBP-67F	1967-68 Front Premium	164.95 ea.
MBP-67R	1967-68 Rear Premium	164.95 ea.
MBP-69F	1969 Front Premium	164.95 ea.
MBP-69R	1969 Rear Premium	164.95 ea.

Oversize 2.



Paintable Bumpers

Set your Camaro apart from the crowd and give it a more modern look with these paintable bumpers.

MKY-67FP	1967-68 Front	119.95 ea.
MKY-67RP	1967-68 Rear	119.95 ea.
MKY-69FP	1969 Front	119.95 ea.
MKY-69RP	1969 Rear	119.95 ea.



1974-77 Bumper Strips

Correct rubber strips that go on the front and rear bumpers.

MBS-74F	1977-74 All Front	199.99 ea.
MBS-74R	1977-74 All Rear	199.99 ea.

Triple Chrome Plated Bumpers

These are high quality reproduction bumpers which are perfect for daily drivers and show cars alike. Each bumper starts out with a nickel core and is then triple chrome plated for a beautiful shine.

MKY-1220	1967-68 Front	99.95 ea.
MKY-1222	1969 Front	99.95 ea.
3986576	1970-73 Standard Front	169.95 ea.
MCI-9230	1970-73 Rally Sport Front 2pc	159.99 ea.
MKY-1221	1967-68 Rear	99.95 ea.
MKY-7424	1969 Rear	99.95 ea.
MKY-772	1970-73 Rear	159.95 ea.

All bumpers ship Oversize.



MED-456 installed on our own 1969 Camaro.

1969 Endura Front Bumpers

Excellent quality reproduction of the optional endura bumper. This was an option on 1969 Camaros for those who wanted something other than a chrome bumper. The endura bumper was painted the same color as the car with high gloss acrylic lacquer. This will add an awesome "factory customized" look to your Camaro!

MED-456	1969 All	397.99 ea.
---------	----------	------------

Ships Oversize.



1982-92 Impact Bars

These are the impact bars which are located underneath the bumper covers.

RIB-82	1982-84 Front	59.95 ea.
RIB-82R	1982-92 Rear	83.95 ea.

No volume discount, ships Oversize 2.



BPX-97KOE

BPX-359

1967-73 Bumper Bolts

Correct OE Bumper Bolts

Correct small head, polished heavy chrome plated bumper bolts. Correct captured washer nuts. Technically correct for concours restorations. Does front and rear bumper.

BPX-97KOE	1967 All	44.99 kit
BPX-99KOE	1968-69 All	44.99 kit

Bolts with Nuts

Complete bumper bolt kits with nuts.

BPX-97K	1967 All 10pc	14.95 kit
BPX-99K	1968 -69 All 10pc	14.95 kit
BPX-2401KIT	1970-73 Std 10pc	17.95 kit
BPX-359	1970-73 RS 12pc	16.95 kit



RBF-596

1970-73 Bumper Filler Panels

Die stamped heavy gauge steel panels to replace the often corroded or missing originals. Fits standard or Rally Sport.

RBF-596	1970-73 All	59.99 pr.
---------	-------------	-----------



MG-35

1970-73 Rear Bumper Gaskets

Molded rubber bumper end fillers.

MG-35	1970-73	29.95 pr.
-------	---------	-----------



MBB-555

1970-73 Bumper Bracket Cushions

MBB-555	1970-72 All, 1973 RS	14.99 pr.
---------	----------------------	-----------



BBF-4266

Bumper Bracket Mounting Hardware

Complete hardware kits for mounting the bumper brackets.

BBF-4266	1967 Front 16pc	20.99 kit
BBF-4274	1967-69 Rear 16pc	12.99 kit
BBF-4225	1969 Front Complete 16pc	20.99 kit
BBF-4273	1969 Front Outer 4pc	8.99 kit
BBF-4269	1969 Front Extension 12pc	7.99 kit
BBF-4614	1970-73 Front RS 10pc	12.99 kit
BBF-4131	1970-72 Front Standard 10pc	12.99 kit
BBF-4141	1973 Front Standard 12pc	15.99 kit
BBF-4137	1970 Rear 8pc	12.99 kit
BBF-5207	1971 Rear 8pc	12.99 kit
BBF-5372	1972-73 Rear 8pc	12.99 kit

Bracket to bumper bolts not included.

Front Bumper Brackets

OE style reproduction bumper brackets.

-  MBB-610L
-  MBB-610R
- MBB-610L 1967-68 Inner LH 22.95 ea.
MBB-610R 1967-68 Inner RH 22.95 ea.
-  MBQ-367L
-  MBQ-367R
- MBQ-367L 1969 Inner LH 22.95 ea.
MBQ-367R 1969 Inner RH 22.95 ea.
-  MIC-69L
-  MIC-69R
- MIC-69L 1969 Inner Extension LH 12.95 ea.
MIC-69R 1969 Inner Extension RH 12.95 ea.
-  MOB-67FL
-  MOB-67FR
- MOB-67FL 1967 Outer LH 21.95 ea.
MOB-67FR 1967 Outer RH 21.95 ea.
-  MOB-68L
-  MOB-68R
- MOB-68L 1968 Outer LH 14.95 ea.
MOB-68R 1968 Outer RH 14.95 ea.
-  MC-510
- MC-510 1968 Front Corner Mounts 16.99 pr.
-  MCB-68
- MCB-68 1968 Center Valance 12.99 ea.
-  MOB-69K
- MOB-69K 1969 Outer Corners 2pc 16.99 pr.

-  MCM-553
- MCM-553 1969 Outer Corners 2pc 14.99 pr.
-  MEB-69A
- MEB-69A 1969 Inner Endura 39.99 pr.
-  MEB-69K
- MEB-69K 1969 Outer Endura 12pc 36.95 kit
-  MBB-295
- MBB-295 1970-73 RS Urethane 89.99 pr.
-  MBB-554
- MBB-554 1970-72 Std, 1970-73 RS Front Inner 69.99 pr.
-  MBB-556
- MBB-556 1970-72 Std, 1970-73 RS Front Outer 57.99 pr.
-  MBB-549
- MBB-549 1970-73 Std 16pc 139.99 kit
-  MBB-987
- MBB-987 1970-73 RS 18pc 209.99 kit
-  MBB-580
- 1970-73 Bumper Bracket Braces**
OE style reproduction front bumper bracket braces.
- MBB-580 1970-73 Standard 49.99 pr.
MBB-580 1970-72 RS 49.99 pr.

Rear Bumper Brackets

OE style reproduction center bumper brackets.

-  MBB-67C
- MBB-67C 1967-68 Rear Center 18.99 ea.
-  MBB-69C
- MBB-69C 1969 Rear Center 16.99 ea.
-  MBB-557
- MBB-557 1970-72 All 5pc 89.99 kit

-  MBB-KIT7
-  MBB-559
- 1967-69 Rear Bumper Bracket Kits**
Includes all correct rear bumper brackets.
- MBB-KIT7 1967-68 All 4pc 42.99 kit
MBB-559 1969 All 4pc 42.99 kit

-  BBF-13
- Bumper Bracket Bolts**
New bumper bracket bolts with correct teeth washers and nut.
- BBF-13 1967-81 Front Inner 6.99 ea.
Note: Fits bracket to subframe only.



RBB-1048QD

1970-73 Front Bumper Brace

This is a correct Camaro front bumper brace which acts as a reinforcement for your non-Rally Sport Camaro.

RBB-1048QD 1970-73 Standard..... 109.95 ea.
Ships Oversize 1



MBG-678F

1967-68 Deluxe Front Bumper Guards

OE style reproduction triple chrome plated front bumper guards, optional on all 1967-68 models. Includes rubber seals and brackets.

MBG-678F 1967-68..... 115.99 kit



MBG-67RX

1967-68 Deluxe Rear Bumper Guards

OE style reproduction triple chrome plated rear bumper guards optional on all 1967-68 models. Includes brackets & hardware.

MBG-67RX-KIT 1967-68..... 105.52 pr.
MBG-67RX 1967-68..... 65.95 ea.



MBG-67RL

1967-68 Standard Rear Bumper Guards

OE style reproduction lower chrome bumperettes.

MBG-67RL 1967-68..... 69.95 pr.



MBG-69RX

1969 Deluxe Rear Bumper Guards

OE style reproduction triple chrome plated rear bumper guards optional on all 1969 models. Include brackets.

MBG-69RX 1969..... 119.99 kit



MBG-69RL

1969 Standard Rear Bumper Guards

OE style reproduction lower chrome bumperettes.

MBG-69RL 1969..... 49.95 pr.



MBG-70RL

1970-73 Standard Rear Bumper Guards

OE style reproduction lower chrome bumperettes. Standard on all models.

MBG-70RL 1970-73..... 89.99 pr.

XTC-045 XTC-059



XTC-057 XTC-043



XTC-250

Fuel Tank Caps

OE style reproduction fuel tank caps with correct logos.

XTC-043 1967-68 Paintable..... 22.95 ea.
XTC-045 1967-68 SS..... 40.99 ea.
XTC-059 1967 SS 350..... 40.99 ea.
XTC-057 1967-68 RS..... 42.99 ea.
XTC-250 1967-68 Bowtie w/ Lock..... 37.99 ea.



LTA-331



LTA-781

1978-81 Tail Panel Applique

OE style reproduction tail lamp applique. Berlinetta features chrome and black center accent bar.

LTA-331 1978-81 Black LH..... 31.99 ea.
LTA-332 1978-81 Black RH..... 31.99 ea.
LTA-781 1979-81 Berlinetta LH..... 33.99 ea.
LTA-782 1979-81 Berlinetta RH..... 33.99 ea.



XTD-507



XTD-789

1978-81 Fuel Door with Hinge

OE style reproduction fuel door with correct pre-drilled holes for emblem. Berlinetta features chrome and black center accent bar.

XTD-507 1978-81 Black..... 88.99 ea.
XTD-789 1979-81 Berlinetta..... 89.99 ea.



MLB-807

MLB-765



MLB-839



MLB-220

Front License Plate Brackets

OE style reproduction front license plate brackets.

MLB-807 1967-68 All..... 16.95 ea.
MLB-765 1969 All..... 16.95 ea.
MLB-839 1970-73 Standard..... 12.99 ea.
MLB-220 1970-73 RS..... 24.99 ea.
XTD-8287 1982-83 All..... 19.95 ea.



XTD-1630



XTD-10B

BTB-56

Fuel Tank Doors

Correct spring loaded fuel tank door.

XTD-1630 1969 Door..... 22.95 ea.
XTD-344 1970-77 Door..... 22.95 ea.
XTD-10B Door Bumper..... 1.95 ea.
BTB-56 Door Bolt..... 1.25 ea.



MLB-78R

1978-81 Rear License Plate Bracket

Correct bracket which screws or rivets to the rear bumper cover.

MLB-78R 1978-81..... 24.95 ea.



HZ-28

Z/28 Spoiler Decal

OE style reproduction Z/28 spoiler decal for your 1970-73 Camaro.

HZ-28 1970-73 Z/28..... 9.99 ea.



MRS-185



MRS-186

1967-69 Rear Spoiler

OE style reproduction fiberglass rear spoilers with correct threaded studs allowing easy replacement into existing holes. Comes complete with mounting template.



BMS-288

MRS-185	1967-68 Reproduction	119.99 ea.
MRS-186	1969 Reproduction	119.99 ea.
BMS-288	1967-69 Attaching Hardware.....	6.50 kit
BSS-391	1967-69 Studs	19.99 kit

Ships Oversize.



MDR-1970

1970-73 Rear Spoiler

OE style reproduction fiberglass rear spoilers with correct threaded studs allowing easy replacement into existing holes.

MDR-1970	1970-73 Z/28 Low Style	139.99 ea.
MR-352	1970-73 3pc	296.07 ea.
MR-353	1974-81 3pc	296.07 ea.
BMS-288	1970-73 Z/28 Low Style Attaching Hardware.....	6.50 kit

Ships Oversize.

See Page 162 For Rally Sport Grille Kits

See Page 173 For Complete 1970-73 RS Nose Conversion

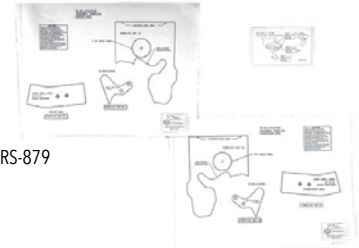

RS-879

Rally Sport Fenderwell Template Kits

These convenient templates accurately locate all needed modification points to standard fenderwells allowing easy and accurate installation of all Rally Sport components.

RS-878	1968 Rally Sport	26.99 ea.
RS-879	1969 Rally Sport	26.99 ea.



RSKIT-676

1967 Rally Sport System Kit

Everything you need to completely replace your tired old Rally Sport hidden headlight system. This kit includes:

- (1) RS Under Dash Diode Harness
- (2) RS Fender Adapter Brackets
- (2) Headlamp Motors
- (1) Delco Remy Relay Board Assembly
- (1) Switch Hardware Set
- (1) Switch Bracket Hardware Set
- (1) Installation Hardware Pack
- (1) RS Front Light Harness
- (2) RS Headlamp Assemblies
- (1) Relay Mounting Plate
- (4) Headlight Limiting Switches
- (1) Limit Switch Bracket Set
- (1) System Circuit Breaker
- (1) 1967 Camaro Assembly Manual

RSKIT-676	1967 6 Cylinder	839.00 kit
RSKIT-8W	1967 V8 w/ Warning Lights	1087.92 kit
RSKIT-8G	1967 V8 w/ Gauges.....	1087.92 kit

No Volume Discount



RSKIT-68C

1968 Rally Sport System Kit

Everything you need to completely replace your tired old Rally Sport hidden headlight system. This kit includes:

- (1) RS Headlamp Switch
- (2) RS Fender Adapter Brackets
- (2) Headlamp Assemblies
- (1) Vacuum Tank
- (1) RS Color Coded Hose Kit
- (2) Actuator Rear Support Brackets
- (2) Door Bumper Set
- (1) Vacuum Relay Switch
- (2) Radiator Door Support Stop Brackets
- (1) Vacuum Actuators
- (2) Vacuum Actuator Shields
- (2) Actuator Clevis Pin Sets
- (1) Actuator Rear Clamp Brackets
- (1) Installation Hardware Pack
- (1) 1968 Camaro Assembly Manual

RSKIT-68	1968 All	906.02 kit
RSKIT-68C	1968 All w/ Chrome Doors.....	942.02 kit

No Volume Discount



RSKIT-69

1969 Rally Sport System Kit

Everything you need to completely replace your tired old Rally Sport hidden headlight system. This kit includes:

- (1) RS Headlamp Switch
- (2) RS Fender Adapter Brackets
- (2) Radiator Support Door Stop Brackets
- (2) Vacuum Actuators
- (2) Actuator Shields
- (2) Actuator Clevis Pin Sets
- (2) Actuator Rear Clamp Brackets
- (1) Door Bumper Set
- (1) Vacuum Relay Switch
- (2) RS Headlamp Assemblies
- (1) Vacuum Tank
- (1) RS Color Coded Hose Kit
- (2) Actuator Rear Support Brackets
- (1) Installation Hardware Pack
- (1) 1969 Camaro Assembly Manual

RSKIT-69	1969 All	893.51 kit
----------	----------------	------------

No Volume Discount





RSKIT-68DSE

1968-69 DSE Rally Sport System Kit

Everything you need to completely replace your tired old Rally Sport hidden headlight system. This kit includes:

- (1) DSE Electronic Headlamp Conversion Kit
- (2) RS Fender Adapter Brackets
- (2) Radiator Support Door Stop Brackets
- (1) Door Bumper Set
- (2) RS Headlamp Assemblies
- (1) 1969 Camaro Assembly Manual

RSKIT-68DSE	1968 All	824.31 kit
RSKIT-68CDSE	1968 All w/ Chrome Doors.....	860.31 kit
RSKIT-69DSE	1969 All	823.41 kit

No Volume Discount



DSE122001

DSE Electric Headlight Door Kit

This DSE electric RS headlight door kit replaces the stock vacuum actuated system on your 1968 or 1969 Camaro Rally Sport. When installed, this kit will operate the headlight doors more reliably, smoother and without the complicated and bulky vacuum accessories. This kit comes with everything you need for installation including two electric actuators, a control module, harness, mounting brackets and hardware.

DSE122002	1968 RS.....	475.99 kit
DSE122003	1969 RS.....	474.99 kit

No Volume Discount

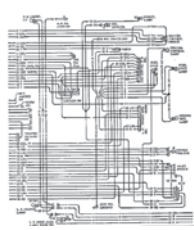

HWD-RS

Rally Sport Wiring Diagram

Original GM wiring schematic for rally sport cars.

HWD-RS	1967-69 RS	9.99 ea.
--------	------------------	----------



KRS-67K

1967 RS Headlamp Assemblies

Complete headlamp door assemblies including headlamp housings, hinge plates, door backing plates, outer black headlamp door covers with moldings and door stop cushions, pivot arms, motor mounting plates, drive washer and nut set, adjusting screws, bushings and hardware. Completely assembled!

KRS-67KR	1967 RS RH.....	179.99 ea.
KRS-67KL	1967 RS LH	179.99 ea.
KRS-67K	1967 RS Pair.....	323.98 kit



KRS-68K

1968 RS Headlamp Assemblies

Complete headlamp door assemblies including headlamp housings, hinge plates, door backing plates, outer black headlamp door covers (with or without trim) moldings and door stop cushions, bellcranks, lower bellcrank support brackets, over center mechanisms with springs, sealed beam adjusting screws and all bushings and hardware. Completely assembled!

KRS-68KR	1968 RS RH.....	179.99 ea.
KRS-68KL	1968 RS LH	179.99 ea.
KRS-68K	1968 RS Pair.....	323.98 kit
KRS-68CR	1968 RS w/ Trim RH.....	199.99 ea.
KRS-68CL	1968 RS w/ Trim LH	199.99 ea.
KRS-68KC	1968 RS w/ Trim Pair	359.98 kit



KRS-69K

1969 RS Headlamp Assemblies

Complete headlamp door assemblies including headlamp housings, hinge plates, door backing plates, bellcranks and bellcrank support brackets, springs, mounting plates, all bushings, sealed beam adjusting screws and needed hardware. Completely assembled.

KRS-69KR	1969 RS RH.....	179.99 ea.
KRS-69KL	1969 RS LH	179.99 ea.
KRS-69K	1969 RS Pair.....	323.98 pr.



KRG-06CL

KRG-06CR

1967-68 Headlamp Door Covers

Correct replacement door covers manufactured in the correct "egg crate" pattern. 1968 Models feature silver edging as original.

KRG-063R	1967 w/o Silver RH	11.99 ea.
KRG-063L	1967 w/o Silver LH	11.99 ea.
KRG-06CR	1968 w/ Silver RH	19.99 ea.
KRG-06CL	1968 w/ Silver LH	19.99 ea.
KRS-8B	1967-68 Screws 8pc.....	3.00 kit



KRQ-425L

1967-68 Headlamp Door Moldings

OE style reproduction headlamp door moldings in matte black and finished with a polished aluminum edge.

KRQ-425R	1967-68 RH.....	34.99 ea.
KRQ-425L	1967-68 LH	34.99 ea.
KRV-916	1967-68 Molding Rivets	6.99 kit



KRQ-102R

KRQ-102L

1969 Outer Headlamp Doors

Accurate fitting die cast outer headlamp door covers coated in black primer for easy painting.

KRQ-102R	1969 RS RH.....	29.99 ea.
KRQ-102L	1969 RS LH	29.99 ea.



KRC-674

1969 Chrome Inner Headlamp Doors

Exceptional reproduction cast and chrome plated inner headlamp doors.

KRC-674	1969 RS.....	77.99 pr.
---------	--------------	-----------



KRQ-261L

1967-68 Headlamp Door Backing Plates

Diecast headlamp door backing plates with black coated phillips machine screws.

KRQ-261R	1967-68 RS RH.....	25.99 ea.
KRQ-261L	1967-68 RS LH	25.99 ea.



KRQ-172L

KRQ-172R

1969 Headlamp Door Backing Plates

Diecast headlamp door backing plates painted in semi flat black.

KRQ-172R	1969 RS RH.....	26.99 ea.
KRQ-172L	1969 RS LH	26.99 ea.



KRQ-164

1967-69 Door Hinge Bolt

OE style reproduction plated bolt and nut.

KRQ-164	1967-69 RS	5.99 ea.
---------	------------------	----------



KRQ-389 KRQ-189

1967-69 Headlamp Door Hinge Plates

Die cast hinge plates unpainted as original. Fits LH or RH.

KRQ-389	1967-68 RS	18.99 ea.
KRQ-189	1969 RS	23.99 ea.



KRQ-154

1967-69 Door Shouldered Bolts

Set of three correct plated shouldered bolts for attaching headlight door. Two sets required per car.

KRQ-154	1967-69 RS 3pc	5.99 set
---------	----------------	----------



KCC-632

KRQ-185

Headlamp Bushing Kits

Complete set of upper and lower headlamp door bushings and washers to repair both door assemblies.

KCC-632	1967 RS 14pc	14.99 set
KRQ-185	1968-69 RS 10pc	16.99 set



LRT-212L

1967 Headlamp Motors

Excellent replacement headlamp motor featuring sealed housings with an all metal precision gear train. Includes mounting plate and wiring connector.

LRT-212L	1967 RS LH	139.99 ea.
LRT-212R	1967 RS RH	139.99 ea.
LRT-212K	1967 RS Pair	251.98 kit



KRQ-388

1967 Headlamp Motor Drive Arm

Accurate die stamped steel reproduction drive arm, black coated.

KRQ-388	1967 RS	11.99 ea.
---------	---------	-----------



KRC-962

1967 Motor Nut & Drive Washers Set

Shouldered nuts, large slotted washers and correct large diameter spring steel cone washers to properly tension friction discs.

KRC-962	1967 RS	13.99 set
---------	---------	-----------



KRQ-205

KRX-398

1967 Rally Sport Headlamp Limiting Switch

Correct headlamp limiting switch with correct attached ground wire.

KRQ-205	1967 RS Switch	23.99 ea.
KRX-398	1967 RS Screw Kit	8.99 kit

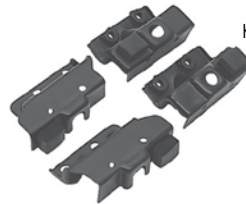

KRQ-398

1967 RS Limiting Switch Bracket Set

Correct limiting switch bracket set used to mount to the headlamp assemblies and core support.

KRQ-398	1967 Bracket Set	32.99 set
---------	------------------	-----------



KW-806

1967 Rally Sport Relay Board Assembly

Complete reproduction assembly with all correct parts. Die stamped steel relay mounting plate with three installed relays.

KW-806	1967 RS	99.99 kit
--------	---------	-----------



KRG-398

1967 Rally Sport Headlamp Relay

Excellent reproduction headlamp relay with stamped Delco Remy script. Mounting bracket includes stamped 858 numerals with accurate finish plating.

KRG-398	1967 Motor Relay	24.99 ea.
KRG-215	1967 Bracket	32.99 ea.



KB-10

1967 Rally Sport Circuit Breaker

OE style reproduction 10 amp restoration circuit breaker including correctly plated mounting bracket, two correct style integral washer nuts to attach wiring connectors.

KB-10	1967 RS	24.99 ea.
-------	---------	-----------



11200

1967 Rally Sport Extension Harness

Correct under dash diode harness.

11200	1967 RS	40.99 ea.
-------	---------	-----------



KRQ-299

1968-69 RS Vacuum Actuators

Excellent replacement vacuum actuator.

KRQ-299	1968-69 RS	69.99 ea.
KRX-299	1968-69 RS Pair	125.98 pr.



KRC-623

1968-69 RS Clevis Pin Kit

Correct actuator clevis pins, bushings & clips. Mounts one actuator. Two required per car.

KRC-623	1968-69 RS	7.99 kit
---------	------------	----------



KRQ-137

KRQ-138

1968-69 RS Actuator Shields

Injection molded ABS actuator shields.

KRQ-137	1968 RS	64.99 pr.
KRQ-138	1969 RS	64.99 pr.
BRQ-13KIT	1968-69 Bolts 8pc	5.95 kit



KRC-24

1968 RS Actuator Support Brackets

Large rear fender brackets in stamped steel, coated black with integral blind nuts.

KRC-24	1968 RS	39.99 pr.
--------	---------------	-----------



KRQ-103

1969 RS Actuator Support Brackets

Large rear fender brackets in stamped steel, coated black with integral blind nuts.

KRQ-103R	1969 RS RH.....	22.99 ea.
KRQ-103L	1969 RS LH.....	22.99 ea.
KRQ-103	1969 RS Pair	38.99 pr.



KRQ-105

1968-69 RS Support Clamp Bracket

Die stamped small rear support clamp bracket. 2 required per car.

KRQ-105	1968-69 RS.....	6.99 ea.
---------	-----------------	----------



KRQ-349

1968-69 RS Vacuum Reservoir

OE style reproduction of original 1968 dual tube and 1969 single vacuum reservoirs. Includes mounting tabs, relay valve bracket and seam treatment as original.

KRQ-348	1968 RS	79.99 ea.
KRQ-349	1969 RS.....	79.99 ea.
BRQ-3KIT	1968-69 Bolts 3pc	1.95 kit



KRK-80

1968-69 RS Vacuum Relay Switch

OE style reproduction vacuum relay valve featuring correct raised text. Controls vacuum to headlight doors.

KRK-80	1968-69 RS.....	69.99 ea.
--------	-----------------	-----------



KRQ-498

KRG-432

1968-69 RS Check Valve & Filter

Correct vacuum line check valve and hose in-line filter.

KRQ-498	1968-69 Check Valve.....	11.99 ea.
KRG-432	1968-69 Filter	4.99 ea.



NW-733

1968 RS Headlamp Hose Kit

Show quality headlamp hose kit including deep impregnated color stripe coded pre-cut hose. Correct weight, color and diameter. Includes T-fittings, firewall grommet, filter original style straps and instructions.

NW-733	1968 RS	74.99 kit
--------	---------------	-----------



NW-633

1969 RS Headlamp Hose Kit

Show quality headlamp hose kit including deep impregnated color stripe coded pre-cut hose. Correct weight, color and diameter. Includes T-fittings, firewall grommet, filter, check valve original style straps and instructions.

NW-633	1969 RS	74.99 kit
--------	---------------	-----------



KRQ-326

1968-69 RS Firewall Hose Grommet

Correct two-hole rubber grommet for firewall.

KRQ-326	1968-69 RS.....	4.99 ea.
---------	-----------------	----------



KRQ-181



KRQ-104

1968-69 RS Headlamp Bellcranks

Accurate stamped steel EDP coated.

KRQ-181R	1968 RS RH.....	21.99 ea.
KRQ-181L	1968 RS LH.....	21.99 ea.
KRQ-181	1968 RS Pair	32.99 pr.
KRQ-104R	1969 RS RH.....	21.99 ea.
KRQ-104L	1969 RS LH.....	21.99 ea.
KRQ-104	1969 RS Pair	36.99 pr.



KRQ-161

KRQ-162

1968-69 RS Bellcrank Support Brackets

Excellent quality stamped steel brackets.

KRQ-161	1968 RS	15.99 pr.
KRQ-162	1969 RS	29.99 pr.



KRC-801

1968-69 RS Radiator Support Stop Brackets

Correct die stamped steel brackets with rubber bumpers installed.

KRC-944	1968 RS Bracket.....	24.99 ea.
KRC-801	1969 RS Bracket.....	29.99 ea.
KSB-1R	1968-69 Bumper Only.....	5.99 ea.



KRQ-175

RS Over Center Bracket & Spring Set

8 piece set includes brackets, washers, springs and lock nuts. Does one car.

KRQ-175	1968 RS	12.95 kit
KRQ-175B	1968 RS (Spring Only).....	9.99 ea.
KRQ-175A	1969 RS (Spring Only).....	9.99 ea.

GHS-542



1968-69 RS Headlight Switch

Correct dash mounted vacuum headlight operation switch.

GHS-542 1968-69 RS 54.99 ea.



RS Fender Adapter Brackets

These are the correct brackets that allow fenders to accept Rally Sport hardware. These are to be used with standard fenders to provide the mounting points for the RS system.

KRB-33 1967-68 32.95 pr.
KRB-34 1969 26.95 pr.

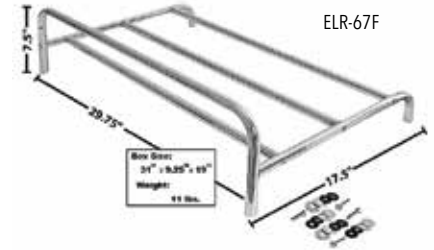

1967-69 Luggage Rack

Originally installed as a dealer option. OE style reproduction with hardware.

ELR-67F 1967-69 149.95 ea.

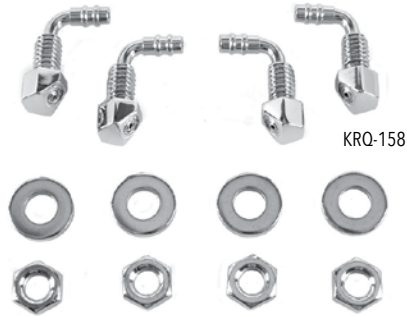

1969 RS Headlight Washer Nozzles

OE style reproduction, heavy chrome plated headlamp washer nozzles, (4) chrome plated thick washers and (4) chrome plated thin nozzle nuts.

KRQ-158 1969 RS 32.99 kit



1969 RS Headlight Washer Hose Set

Correct OEM ribbed washer hose with correct fittings and straps.

NAP-630 1969 RS 22.95 kit



1969 RS Headlight Washer Pump Harness

Correct washer pump extension harness.

17585 1969 RS 15.99 ea.



1970-73 Rally Sport Nose Conversion Kit

Do you have a standard Camaro but love the look of the RS?

This kit gives you virtually everything you need to convert!

- Front Lower Valance (RVP-72)
- Header Panel (RHP-568)
- Hood Release (RHR-73RS)
- Pair of Front Split Bumpers (MCI-9230)
- Bumper Bolt Kit (BPX-359)
- Parking Lamp Housings (LPH-970)
- Bumper Braces Front (MBB-580)
- Urethane Nose (MCI-9447)
- Bumper Brackets for Urethane Nose (MBB-295)
- Grille (LEH-1064)
- Grille Surround Chrome (LK-889)
- Grille Divider Bracket (MK-55)
- Front Bumper Brackets Inner (MBB-554)
- Front Bumper Brackets Outer (MBB-556)
- Grille Divider Insert (MK-57)

RSX-KIT70 1970-73 2032.88 kit

No Volume Discount. Ships Oversize.



Shown installed on our own 70 1/2

Fenders

Our reproduction fenders are manufactured to duplicate the originals in both fit and appearance. All fenders come EDP coated. Just as with original GM fenders, we recommend test fitting before painting.

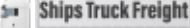
No Volume Discount. All fenders ship Truck Freight to a commercial address. 

RF-67SL



- RF-67SL 1967 Standard LH..... 219.95 ea.
- RF-67SR 1967 Standard RH..... 219.95 ea.
- RF-67RL 1967 Rally Sport LH..... 219.95 ea.
- RF-67RR 1967 Rally Sport RH..... 219.95 ea.

RF-68RL



- RF-68SL 1968 Standard LH..... 195.95 ea.
- RF-68SR 1968 Standard RH..... 195.95 ea.
- RF-68RL 1968 Rally Sport LH..... 195.95 ea.
- RF-68RR 1968 Rally Sport RH..... 195.95 ea.

RF-69RL



- RF-69RL 1969 All LH..... 199.95 ea.
- RF-69RR 1969 All RH..... 199.95 ea.

All fenders include a Rally Sport bracket which can be removed for standard models.

RF-70L



- RF-70L 1970-77 All LH..... 184.95 ea.
- RF-70R 1970-77 All RH..... 184.95 ea.



RF-781L

- RF-781L 1978-81 w/o Z/28 LH..... 169.95 ea.
- RF-781R 1978-81 w/o Z/28 RH..... 169.95 ea.



RF-781ZL

- RF-781ZL 1978-81 Z/28 LH..... 169.95 ea.
- RF-781ZR 1978-81 Z/28 RH..... 169.95 ea.



RF-8290L

- RF-8290L 1982-90 Z/28 LH..... 119.95 ea.
- RF-8290R 1982-90 Z/28 RH..... 119.95 ea.



RF-9192L

- RF-9192L 1991-92 Z/28 LH..... 99.95 ea.
- RF-9192R 1991-92 Z/28 RH..... 99.95 ea.



RF-67XL



RF-69XL



RF-67XR



RF-69XR



Lower Fender Extensions

OE style reproduction fender extensions which fill the area between the lower valance panel and the fender.

RF-67XL	1967-68 LH	29.95 ea.
RF-67XR	1967-68 RH	29.95 ea.
RF-69XL	1969 LH	29.95 ea.
RF-69XR	1969 RH	29.95 ea.
RF-78XL	1978-81 LH w/o Spoiler Holes*	79.95 ea.
RF-78XR	1978-81 RH w/o Spoiler Holes*	79.95 ea.

*Must Drill Holes For Spoiler



RFP-69L

Fender Patches

High quality fender patches for this commonly rusted area.

RFP-678L	1967-68 LH	69.99 ea.
RFP-678R	1967-68 RH	69.99 ea.
RFP-69L	1969 LH w/ Brace	54.95 ea.
RFP-69R	1969 RH w/ Brace	54.95 ea.
RFP-781L	1970-81 LH	29.95 ea.
RFP-781R	1970-81 RH	29.95 ea.



RFB-1038R

RFB-1038G

Inner Fender Well Braces

Correct steel curved braces that attach to the rear of the inner fender well to the firewall.

RFB-1038R	1967-69 RH	19.95 ea.
RFB-1038L	1967-69 LH	19.95 ea.
RFB-1038K	1967-69 LH/RH Pair	35.91 kit
RFB-1038G	1970-73 RH	26.95 ea.
RFB-1038H	1970-73 LH	26.95 ea.



BFE-9001

Front End Fastener Kit

Over 175 pieces all individually bagged to attach all of your front end sheet metal including fenders, grille, inner fenders, hood, etc.

BFE-9001	1967-68 All	45.95 kit
BFE-9002	1969 All	45.95 kit
BFE-9003	1970-81 All	45.95 kit



RFB-656

Fender Support Bars

These OE style reproduction fender support bars extend from the side of the fenders to the top of the radiator support. Finished in your choice of black or chrome.

RFB-656	1967-69 Black	16.99 pr.
RFB-653	1967-69 Chrome	18.99 pr.
RFB-7081B	1970-81 Black	18.95 pr.
RFB-7081C	1970-81 Chrome	18.95 pr.



RIF-678L

Front Inner Fenders

Brand new die-stamped inner fender wells. Buy the pair and save.

RIF-678L	1967-68 LH	89.95 ea.
RIF-678R	1967-68 RH	89.95 ea.
RIF-678K	1967-68 LH/RH	186.17 kit
RIF-68RS-L	1968 RS LH	119.95 ea.
RIF-68RS-R	1968 RS RH	119.95 ea.
RIF-69FL	1969 LH	89.95 ea.
RIF-69FR	1969 RH	89.95 ea.
RIF-69FK	1969 LH/RH	186.17 kit
RIF-69RS-L	1969 RS LH	119.95 ea.
RIF-69RS-R	1969 RS RH	119.95 ea.
RIF-70FL	1970-81 LH	99.95 ea.
RIF-70FR	1970-81 RH	99.95 ea.
RIF-70FK	1970-81 LH/RH	179.91 kit

Ships Oversize 2.



RRS-070R

Radiator Support

Excellent quality reproduction radiator support. Black EDP coated.

RRS-067R	1967-69 All	79.95 ea.
RRS-070R	1970-73 All	121.99 ea.
RRS-77	1974-77	349.99 ea.
RRS-781	1978-81	369.95 ea.

No Volume Discount. Ships Oversize 2.



DRS-67H

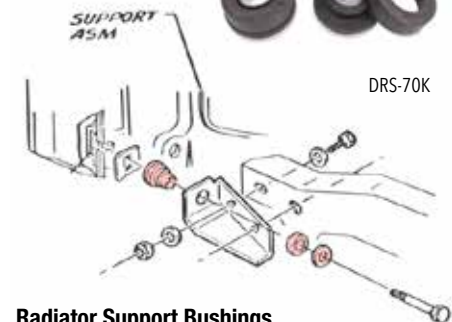

DRS-70K

Radiator Support Bushings

Complete kit with all bushings and hardware for mounting radiator support to car.

DRS-67H	1967-81 All	21.52 kit
DRS-70K	1970-73 Side Bushings*	26.99 kit
RRS-070-SB	1970-73 Brackets	42.99 pr.

*Does not fasten to frame and does not include hardware

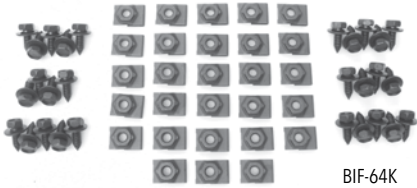

BIF-64K

Fender Inner Bolt Kit To Fender

BIF-64K All 56pc.....26.95 ea.



BCW-51

Fender Cup Washers

BCW-51 All Zinc.....3.95 ea.



CA109

A-Arm Dust Shields

Correct die stamped material that seals the engine compartment. Mounts to inner fender wells, complete with staples.

CA109	1967-68 Complete 5pc.....	21.99 kit
CA110	1969 Complete 5pc.....	21.99 kit
JHC-105	1967-68 A-Arms Only.....	13.99 pr.
JHC-106	1969 A-Arms Only.....	11.99 pr.
JHC-110	1970-81 A-Arms Only.....	11.99 pr.
JHC-108	1967-69 Fender/Cowl.....	5.99 ea.
JHC-107	1967-69 Frame.....	8.99 pr.



4022-150-82

1982-92 Upper Fender Tie Bar

4022-150-82 All.....54.95 ea.
Ships Oversize 2.



RFL-7878

1978-81 Fender Louvers

High quality fender vent louvers for Z/28 models. Manufactured in die-cast zinc, paint to match.

RFL-78K	1978-79.....	236.99 pr.
RFL-7878	1978-79 Mounting Hardware.....	79.99 pr.
RFL-80K	1980-81.....	290.99 pr.
RFL-8080	1980-81 Mounting Hardware.....	69.99 pr.

AMK inc
PRODUCTS



Detail shot of a 1968 Camaro Master Body Hardware kit. These kits have all of the hard to find items that are not available anywhere else!

What Your Body Needs!

AMK Products

Master Body Kit

Master body kits contain just about every piece of hardware to assemble the body of your Camaro. Each kit contains hardware for your battery tray, bumpers, filler panel, filler panel moldings, bumper brackets, cowl vent panel, door latches, emblems, fender braces, fenders, front tie bar, grille, grille brackets, grille moldings, headlamps, headlamp bezels, hood, hood hinges, hood latch, hood latch support, license plate, mirrors, parking lamps, tail lamps, trunk latch, trunk lid hinges, wheel opening moldings, wheelhouses, radiator support and more! This kit truly has it all!

67FB-S	1967 Standard.....	223.99 kit
67FB-RS	1967 Rally Sport.....	222.99 kit
68FB-S	1968 Standard.....	223.99 kit
68FB-RS	1968 Rally Sport.....	223.99 kit
69FB-S	1969 Standard.....	223.99 kit
69FB-RS	1969 Rally Sport.....	221.99 kit
70FB-S	1970-72 Standard.....	222.99 kit
70FB-RS	1970-72 Rally Sport.....	219.99 kit
73FB-S	1973 Standard.....	231.99 kit
73FB-RS	1973 Rally Sport.....	219.99 kit
74FB	1974-76 All.....	249.99 kit
77FB	1977 All.....	284.99 kit
78FB	1978 All.....	304.99 kit
79FB	1979 All.....	259.99 kit
80FB	1980-81 All.....	270.99 kit

No Volume Discount.



Style 1 in Black Anodized ACG-67F1B



Style 2 in Black Anodized ACG-67F2B

Cowl Hood Grilles

If you're tired of looking at the hole in the back side of your cowl hood, this 1967-69 Camaro cowl hood grille is the answer. Constructed of 16 gauge aluminum, this cowl hood grille will keep things looking neat while keeping out debris.

ACG-67F1C	1967-69 Style 1 Clear Anodized.....	41.99 ea.
ACG-67F1B	1967-69 Style 1 Black Anodized.....	41.99 ea.
ACG-67F1P	1967-69 Style 1 Polished.....	41.99 ea.
ACG-67F2C	1967-69 Style 2 Clear Anodized.....	41.99 ea.
ACG-67F2B	1967-69 Style 2 Black Anodized.....	41.99 ea.
ACG-67F2P	1967-69 Style 2 Polished.....	41.99 ea.



TM-30040

ProStyle Cowl Induction Trim Plates

Dress up the unsightly hole in the back of the hood with a ProStyle cowl induction trim plate from Twist Machine. Airflow is not restricted. Includes stainless steel hardware.

TM-30045	1967-69 Brushed (GM Hood).....	72.95 ea.
TM-30145	1967-69 Black (GM Hood).....	82.95 ea.



DSE011801

Detroit Speed Fender Brace Kit

This new DSE Camaro fender brace kit is another way to beautify your engine compartment. The fender braces are 100 percent CNC machined Clevis' from 304 stainless steel. The kit includes fabricated mounting brackets and comes with button head stainless steel mounting bolts. The fender braces triangulate the radiator core support to the fender and are fully adjustable (a benefit not available with your stock fender braces). All mounting brackets come powdercoated satin black.

DSE011801	1967-69 All.....	208.99 kit
DSE011802	1970-81 All.....	208.99 kit

No Volume Discount

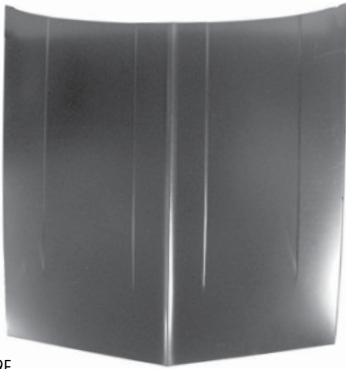

RH-69F

1967-69 Standard Hood

OE style reproduction standard flat hood, perfect for an original restoration.

RH-69F 1967-69 All 239.95 ea.
No Volume Discount. Ships Truck Freight.

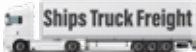

RH-6955

1967-69 Super Sport Hood

OE style reproduction steel Super Sport hood.

RH-6955 1967-69 SS 239.95 ea.
RH-69SSK 1968-69 SS w/ Hood Louvers 350.95 kit
No Volume Discount. Ships Truck Freight.

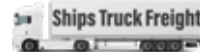

RH-6795

1967-69 Stinger Style Steel Hood

Give your Camaro that big block look with this steel stinger hood similar to the hood equipped on 1967 big block Corvettes and Yenko Camaros. Works with your factory hood hinges.

RH-6795 1967-69 All 439.95 ea.
No Volume Discount. Ships Truck Freight.

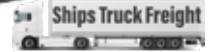

RH-69R

1967-69 Cowl Induction Hood

Add some muscle to your standard Camaro or replace your original cowl induction hood with this OE style reproduction. This is a factory style steel cowl induction hood.

RH-69R 1967-69 199.95 ea.
No Volume Discount. Ships Truck Freight.

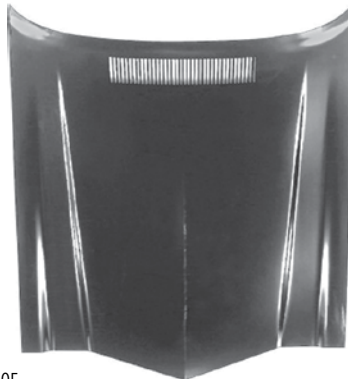

RH-70F

1970-81 Standard Hood

OE style reproduction standard flat hood, perfect for an original restoration.

RH-70F 1970-81 All 369.95 ea.
No Volume Discount. Ships Truck Freight.

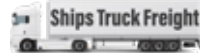

RH-679L88

1967-69 L88 Style Steel Hood

Give your Camaro that big block look with this steel stinger hood similar to the hood equipped on 1967-69 L88 Corvettes. Works with your factory hood hinges.

RH-679L88 1967-69 All 419.95 ea.
No Volume Discount. Ships Truck Freight.



RH-69RS

1967-69 4" Cowl Hood

Let people know that your Camaro means business with this massive 4" steel cowl induction hood. This is not a cheap fiberglass hood. It can be used with your factory hinges and hood latch and is perfect for tall air cleaners or when you want that serious muscle car look.

RH-69RS 1967-69 All 289.95 ea.
No Volume Discount. Ships Truck Freight.

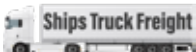

RH-78CI

1970-81 Cowl Induction Hood

This is the hood that GM should have made from the factory! Add some muscle to your Camaro with this 2" cowl hood. This hood is perfect for street machines and will really give your ride the ultimate muscle car look!

RH-78CI 1970-81 All 319.95 ea.
No Volume Discount. Ships Truck Freight.

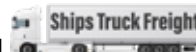

RH-82-4

1982-92 Cowl Hood

Give your Camaro that performance look with one of these cowl hoods. Available in 2" and 4" .

RH-82-2 1982-92 2" 319.95 ea.
RH-82-4 1982-92 4" 319.95 ea.
No volume discount. Ships Truck Freight.



Eddie Motorsports Billet Hood Hinges

This is a set of awesome Eddie Motorsports billet Camaro hood hinges complete with hardware. These hinges feature modern style struts so no springs or props are required.
R=Red, B=Blue, W=White,



MS148-50MBA



MS149-50P



Steel 1967-69

MS149-50BKA	Black Anodized	690.99 pr.
MS149-50BK	Gloss Black.....	635.99 pr.
MS149-50CA	Clear Anodized	690.99 pr.
MS149-50_	Specify Color.....	690.99 pr.
MS149-50CL	Clear Coat	690.99 pr.

Fiberglass 1967-69

MS149-50FBA	Black Anodized	690.99 pr.
MS149-50FBK	Gloss Black.....	635.99 pr.
MS149-50FCA	Clear Anodized	690.99 pr.
MS149-50F_	Specify Color.....	690.99 pr.
MS149-50FCL	Clear Coat	690.99 pr.
MS149-50FMB	Machined	580.99 pr.
MS149-50FBMB	Matte Black.....	635.99 pr.
MS149-50FP	Polished.....	635.99 pr.

Steel 1970-81

MS149-52BKA	Black Anodized	745.99 pr.
MS149-52BK	Gloss Black.....	695.99 pr.
MS149-52CA	Clear Anodized	745.99 pr.
MS149-52_	Specify Color.....	745.99 pr.
MS149-52CL	Clear Coat	745.99 pr.
MS149-52M	Machined	640.99 pr.

Fiberglass 1970-81

MS149-52FBA	Black Anodized	745.99 pr.
MS149-52FBK	Gloss Black.....	695.99 pr.
MS149-52FCA	Clear Anodized	745.99 pr.
MS149-52F_	Specify Color.....	745.99 pr.
MS149-52FCL	Clear Coat	745.99 pr.
MS149-52FMB	Machined	640.99 pr.
MS149-52FBMB	Matte Black.....	695.99 pr.
MS149-52FP	Polished.....	695.99 pr.



RHG-667L

Hood Hinges

Your choice of high quality, OE style reproduction hood hinges or GM licensed hinges.

GM Licensed

RHG-667L	1967-69 LH	119.99 ea.
RHG-667R	1967-69 RH	119.99 ea.

Reproduction

RHG-142L	1967-69 LH	39.95 ea.
RHG-142R	1967-69 RH	39.95 ea.
RHG-142K	1967-69 w/ Bolts.....	68.08 kit
RHG-129L	1970-81 LH	54.95 ea.
RHG-129R	1970-81 RH	54.95 ea.
RHG-129K	1970-81 w/ Bolts.....	86.33 kit

Universal Chrome Hood Pin Kits Peel N Stick



These hood pin kits are a great way to add that pro-touring/ racing looks without drilling or cutting your hood. The pin mounts are either chrome plated or black aluminum with chrome pins and feature rubber coated cables. They attach with high quality double sided 3M adhesive tape.

HPK-BC	Chrome All	29.99 kit
HPK-BB	Black All.....	26.99 kit



HPK-BLACK



HPK-CHROME



RHG-955

Chrome Hood Hinges

OE style chrome plated hood hinges stamped from high strength steel.

RHG-955	1967-69 All	360.99 pr.
---------	-------------------	------------



RHG-BH11

Billet Hood Hinges

Give your engine bay a custom touch with these affordable billet hood hinges! These hood hinges come complete with heavy duty struts and hardware.

RHG-BH11	1967-69 All	499.95 kit
----------	-------------------	------------

No volume Discount.



RHG-142WSK

Assembled Hood Hinges

These are OE style reproduction hood hinges which will replace your originals perfectly. These hinges include a pre-installed spring which makes installation a snap.

RHG-142WSL	1967-69 LH All	49.95 ea.
RHG-142WSR	1967-69 RH All	49.95 ea.
RHG-142WSK	1967-69 Pair All	89.91 ea.



RC-661

GCS-S9473

Hood Catch

Correct catch which mounts on underside of hood. Chrome or black.

RC-661	1967-81 Black.....	20.99 ea.
GCS-S9473	1967-81 Chrome	16.79 kit



MS276-10P

1967-81 Billet Hood Latch Assembly

M = Machined, P = Polished, CL = Clear Coat, BKA = Gloss Black Anodized, CA = Clear Anodized, BK = Gloss Black Finish, MBA = Matte Black Finish

	M	P	All Others
MS276-10_	126.99 ea.	149.99 ea.	175.95 ea.



RLS-225

Hood Latch Support

Correct hood latch support which mounts vertically between the grille and the radiator support.

RLS-225	1967-68 All	22.95 ea.
RLS-220	1969 All	22.95 ea.
RLS-1068NA	1970-73 All	29.95 ea.
RLS-369	1978-81 LH	49.99 ea.
RLS-477	1974-81 RH	54.99 ea.



RHS-25

Hood Hinge Spring

Brand new GM hood springs.

RHS-25	1967-69 Std/Cowl Ind.....	15.95 ea.
RHS-272	1967-69 SS	15.95 ea.
RHS-272	1970-81 All	15.95 ea.



BCB-12955

BPQ-4011

Hood Adjustment Bolts

BPQ-4011	1967-69	9.95 kit
BPQ-4011-70-REAR	1970-81 Rear	15.99 pr.
BPQ-4011-CNTR	1970-81 Rear Center.....	17.99 kit
BCB-12955	1970-81 On Hood Bumper.....	18.95 pr.

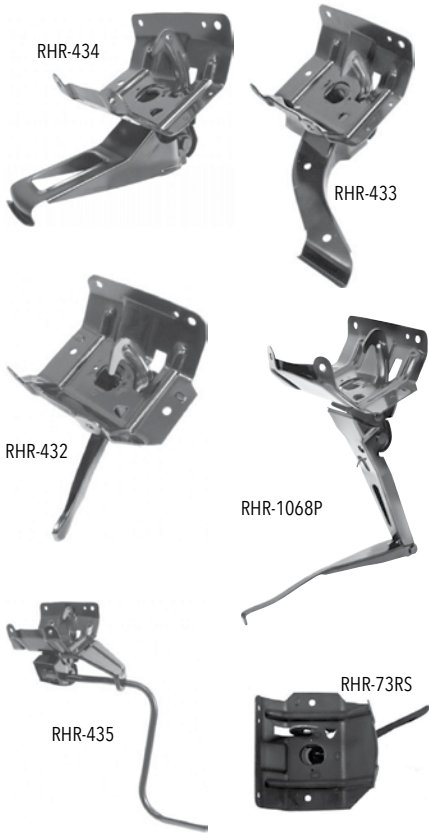

Hood Latches

OE style reproduction hood release assemblies.

RHR-434	1967 Std	59.95 ea.
RHR-433	1968 Std	59.95 ea.
RHR-435	1967-68 RS	59.95 ea.
RHR-432	1969 All	59.95 ea.
RHL-1068P	1970-73 Std	79.95 ea.
RHR-73RS	1970-73 RS	89.99 ea.

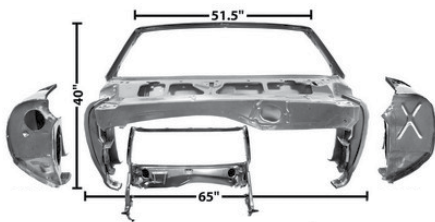

RWC-1073G

1969 Convertible Windshield and Cowl Assembly

This is a complete replacement windshield and cowl assembly area. This massive piece is designed to replace all of this commonly rotted out area on your convertible. This assembly includes the complete cowl area with shoulders and windshield frame.

RWC-1073G 1969 Convertible..... 1039.95 ea.
 Note: Will NOT fit coupe.
 Ships Truck Freight to a commercial address.
 No Volume Discount.



Front Lower Valance Panel

OE style reproduction steel valance panels ready to prep and paint.

RVP-567	1967-68 Standard.....	54.95 ea.
RVP-671	1967 Rally Sport	54.95 ea.
RVP-681	1968 Rally Sport	54.95 ea.
RVP-686	1969 All	59.99 ea.
RVP-544	1970-73 Standard.....	189.95 ea.
RVP-7Z	1970-73 Rally Sport.....	255.99 ea.

Ships Oversize. No Volume Discount.



1970-73 Bumper Filler Panels

Die stamped heavy gauge steel panels to replace the often corroded or missing originals. Fits standard or Rally Sport.

RBF-596	1970-73 All	59.99 pr.
---------	-------------------	-----------



1970-81 Cowl Vent Screen

A high quality reproduction of the plastic screen that keeps debris out of the cowl.

KVS-774	All	59.99 ea.
BPX-7V	Screws	5.95 kit

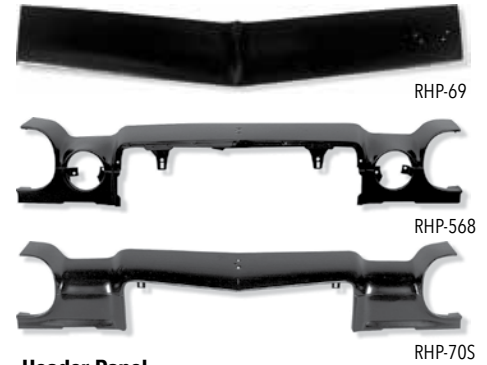

Header Panel

OE style reproduction steel panel which installs directly in front of the hood.

RHP-678	1967-68 All	54.95 ea.
RHP-69	1969 All	59.95 ea.
RHP-568	1970-73 Rally Sport.....	209.95 ea.
RHP-70S	1970-73 Standard.....	179.99 ea.

Ships Oversize. No Volume Discount.



RDP-70



BPX-9V

Cowl Vent Panel

Louvered sheet metal piece which installs directly below the windshield and behind the hood.

RCP-610R	1967-69	95.95 ea.
RDP-70	1970-73	169.95 ea.
BPX-9V	1967-69 Vent Panel Screws	6.95 kit

Ships Oversize. No Volume Discount.

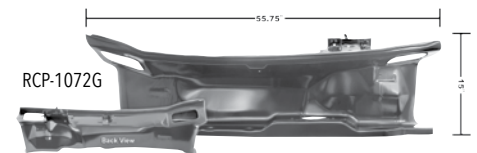

RCP-1072G

1970-73 Lower Cowl Panel Valley

This is an OE style reproduction lower cowl panel valley assembly which will replace this often rotted out area on your Camaro.

RCP-1072G	1970-73	289.95 ea.
-----------	---------------	------------

Ships Oversize 2. No Volume Discount



RDP-439

Dash Top Panel

Correct reproduction of the inner metal dash panel assembly. Extends from the windshield area to the instrument panel assembly where the dash pad mounts. Welding is required when installing this panel.

RDP-437	1967 All	69.95 ea.
RDP-437-A	1967 All OE style*	99.95 ea.
RDP-438	1968 All	69.95 ea.
RDP-438-A	1968 All OE style*	99.95 ea.
RDP-439	1969 All	69.95 ea.
RDP-439-A	1969 All OE style*	99.95 ea.

Ships Oversize. No Volume Discount.

*Adds additional coverage.



RDP-1068EA

Complete Dash Panel

This long awaited dash panel comes fully assembled and ready to install. This is the same piece that is currently being used on the Dynacorn complete Camaro bodies.

RDP-1068CA	1967 w/ AC	289.95 ea.
RDP-672C	1967 w/o AC	259.95 ea.
RDP-1068DA	1968 All	289.95 ea.
RDP-1068EA	1969 All	289.95 ea.

Ships Oversize. No Volume Discount.



RCP-1072B

Top Inner Cowl Panel

This top of cowl assembly features a complete panel with wiper valley all in a sealed unit. A great item to repair your original rusted out piece.

RCP-1072	1967 w/ AC Only	299.95 ea.
RCP-1072A	1968 All	299.95 ea.
RCP-1072B	1969 All	299.95 ea.

Ships Oversize. No Volume Discount.



Upper Inner Cowl Panel

RCP-67UP-AC

The perfect replacement for this commonly rotted out area.

RCP-67UP-AC	1967 w/ A/C	174.95 ea.
RCP-689UP	1968-69 w/o A/C	180.95 ea.
RCP-689UP-AC	1968-69 w/ A/C	180.95 ea.

Ships Oversize. No Volume Discount.



RFB-1046S

Firewall Brackets

OE style reproduction of the often rotted firewall brackets which provide the mounting points for the body mounts.

RFB-67FL	1967-69 LH	69.95 ea.
RFB-67FR	1967-69 RH	69.95 ea.
RFB-1046S	1970-73 All	129.95 pr.



RFW-1046D

Firewalls

Brand new complete firewalls.

RFW-1046F	1967 Heater Delete	269.95 ea.
RFW-1046Q	1967 w/ Heater	269.95 ea.
RFW-1046D	1967 w/ Air Conditioning	269.95 ea.
RFW-1046H	1968-69 Heater Delete	249.95 ea.
RFW-1046G	1968-69 w/ Heater	269.95 ea.
RFW-1046I	1968-69 w/ Air Conditioning	269.95 ea.
RFW-1046R	1970-73 w/ Heater (w/ brackets)	369.95 ea.

Ships Truck Freight to a commercial address. No Volume Discount.



RFC-1046GA

Custom Firewall Cover

This weld on cover, covers up the holes in the firewall leaving you with a smooth, custom firewall that is great for your show car or custom Camaro.

RFC-1046GA	1968-69	299.95 ea.
------------	---------	------------

Ships Oversize. No Volume Discount.



RFB-1046L

RFB-1046M

1969 Firewall to Floor Pan Braces

These steel pieces extend from the firewall down to the floor cross brace.

RFB-1046L	1969 RH	49.95 ea.
RFB-1046M	1969 LH	49.95 ea.



RD-67

Dash Panel Face

Great piece for replacing your original rusted dash.

RD-67	1967 w/o AC	239.95 ea.
RD-67AC	1967 w/ AC	239.95 ea.
RD-68	1968 w/o AC	239.95 ea.

Ships Oversize. No Volume Discount.



IDH-181

Door Mounting Hardware Kit

Correct Camaro door hardware for mounting door opening mechanism, door latch, window tracks, upper glass sash, inner sash and door opening rod guide bracket. One kit required per door.

IDH-181	1967 All 20pc	16.99 kit
IDH-182	1968-69 All 27pc	19.99 kit
IDH-183	1980-81 All 27pc	21.99 kit

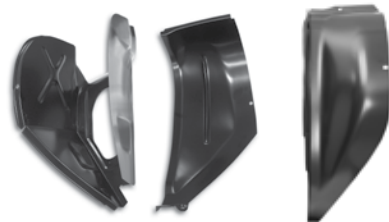

RCP-1073L

RCP-7073R

Lower Cowl Panel Shoulder Assembly

Our complete 1967-69 assembly will replace your rotted out factory originals. This is a complete replacement panel and features all correct cowl openings and ducting.

RCP-1073L	1967-69 LH	89.95 ea.
RCP-1073R	1967-69 RH	89.95 ea.
RCP-7073L	1970-81 LH*	59.95 ea.
RCP-7073R	1970-81 RH*	59.95 ea.
RCP-679L	1967-69 LH*	44.95 ea.
RCP-679R	1967-69 RH*	44.95 ea.
RCP-679K	1967-69 LH/RH* Pair	80.91 kit

*Outer Skin Only.



RSH-67FL

Door Shells

These full door shells feature the outer skin welded to the shell as original. These complete doors are perfect when original doors are rotted all the way through.

RSH-67FL	1967 All LH	289.95 ea.
RSH-67FR	1967 All RH	289.95 ea.
RSH-68FL	1968 All LH	289.95 ea.
RSH-68FR	1968 All RH	289.95 ea.
RSH-1076DX	1968 LH Smooth (No Holes)	349.95 ea.
RSH-1076CX	1968 RH Smooth (No Holes)	349.95 ea.
RSH-69FL	1969 All LH	299.95 ea.
RSH-69FR	1969 All RH	299.95 ea.
RSH-1076FY	1969 LH Smooth (No Holes)	349.95 ea.
RSH-1076EY	1969 RH Smooth (No Holes)	349.95 ea.
RSH-74FL	1970-74 All LH	569.95 ea.
RSH-74FR	1970-74 All RH	569.95 ea.
RSH-75L	1975-81 All LH	599.95 ea.
RSH-75R	1975-81 All RH	599.95 ea.

Ships Truck Freight to a commercial address.



RDS-67FL

Door Skins

Die stamped steel door skins are perfect when your inner door structures are in good shape. These skins weld over your existing inner door.

RDS-67FL	1967 All LH	95.95 ea.
RDS-67FR	1967 All RH	95.95 ea.
RDS-68FL	1968 All LH	95.95 ea.
RDS-68FR	1968 All RH	95.95 ea.
RDS-69FL	1969 All LH	95.95 ea.
RDS-69FR	1969 All RH	95.95 ea.
RDS-70FL	1970-81 All LH	84.95 ea.
RDS-70FR	1970-81 All RH	84.95 ea.
RDB-70FL	1970-81 LH Door Inner Frame Bottom*	129.99 ea.
RDB-70FR	1970-81 RH Door Inner Frame Bottom*	129.99 ea.

* Works with outer skin to repair your factory door shell. Ships Oversize 2.

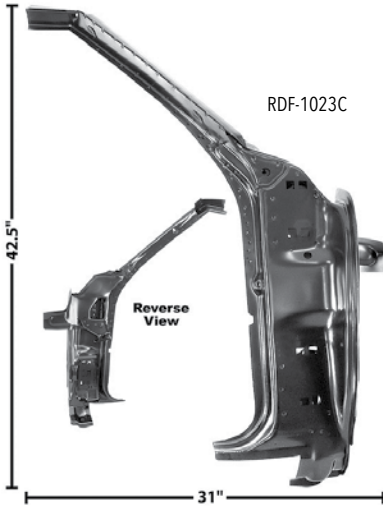

Door Inner Frame A-Pillars

OE style reproduction inner door frame and A-pillar assembly. Parts of this area (especially the door hinge mounting locations) are commonly rotted out on Camaros. Complete replacement.

RDF-1021D	1967 LH	319.95 ea.
RDF-1021C	1967 RH	319.95 ea.
RDF-1023H	1968 LH	335.95 ea.
RDF-1023G	1968 RH	335.95 ea.
RDF-1023D	1969 LH	335.95 ea.
RDF-1023C	1969 RH	335.95 ea.

Upsize 2



REG-67FL



REG-68FXL

REG-67FRL



REG-71FR

Window Regulators

OE style reproduction window regulators complete and ready to install. Available for standard and deluxe interiors.

Door Windows

REG-67FL	1967 Standard LH	69.95 ea.
REG-67FR	1967 Standard RH	69.95 ea.
REG-67FK	1967 Standard LH/RH	118.92 kit
REG-67FXL	1967 Deluxe LH	69.95 ea.
REG-67FXR	1967 Deluxe RH	69.95 ea.
REG-68FL	1968-69 Standard LH	69.95 ea.
REG-68FR	1968-69 Standard RH	69.95 ea.
REG-68FK	1968-69 Standard LH/RH	118.92 kit
REG-68FXL	1968-69 Deluxe LH	69.95 ea.
REG-68FXR	1968-69 Deluxe RH	69.95 ea.
REG-71FL	1970-81 All LH*	69.95 ea.
REG-71FR	1970-81 All RH*	69.95 ea.
REG-71FK	1970-81 All LH/RH*	118.92 kit

Quarter Windows

REG-67FRL	1967-69 All LH	69.95 ea.
REG-67FRR	1967-69 All RH	69.95 ea.

*Will not work on 72-73 Deluxe Interior.



RPP-956

Inner Rear Quarter Patch Panels

Correct repair panel for the lower half of the inner body panel that the rear window regulator mounts to. Easily and professionally repairs the commonly rusted area at the floor and rocker panel.

RPP-957	1967-69 LH	86.99 ea.
RPP-956	1967-69 RH	86.99 ea.



RHS-9



BAV-2622



BAV-2623

Door Hinge Hardware

Correct OEM bolts and heavy spring.

BAV-2622	1967 Phillips	1.99 ea.
BAV-2622K	1967 Phillips 24pc	38.21 kit
BAV-2623	1968-81 Hex	1.99 ea.
BAV-2623K	1968-81 Hex 24pc	38.21 kit
RHS-9	1967-81 Spring	8.99 ea.



RDR-67



RDR-689K

Hinge Detent Rollers

Correct machined detent rollers for lower hinges.

RDR-67	1967 All	16.95 kit
RDR-689K	1968-69 All	21.99 pr.



BPX-1225

Door Hinge Pin Kits

Correct hinge pins and brass bushings for repairing all 4 of your door hinges.

BPX-1225	1967-69 12pc	14.95 ea.
BPX-2225	1970-81 12pc	13.99 ea.

*May require slight drilling to hinges.



RDL-70FL

Door Latch Assemblies

OE style reproduction door latch assemblies.

RDL-67FL	1967 All LH	69.95 ea.
RDL-67FR	1967 All RH	69.95 ea.
RDL-67FK	1967 All LH/RH	111.92 kit
RDL-68FL	1968 All LH	69.95 ea.
RDL-68FR	1968 All RH	69.95 ea.
RDL-68FK	1968 All LH/RH	111.92 kit
RDL-69FL	1969 All LH	69.95 ea.
RDL-69FR	1969 All RH	69.95 ea.
RDL-69FK	1969 All LH/RH	111.92 kit
RDL-70FL	1970-81 All LH	69.95 ea.
RDL-70FR	1970-81 All RH	69.95 ea.
RDL-70FK	1970-81 All LH/RH	111.92 pr.
RDL-SCREW	1967-81 All (Set of 3)*	6.95 set
RDL-828L	1982-87 LH	79.99 ea.
RDL-828R	1982-87 RH	79.99 ea.

*Note: Does one door.



RDH-529U

RDH-346LL

1967 Door Hinges

OE style reproduction replacement door hinges.

RDH-529U	1967 Upper LH & RH	49.95 ea.
RDH-346LL	1967 Lower LH	49.95 ea.
RDH-346LR	1967 Lower RH	49.95 ea.



RDH-120UL



RDH-248LL

1968 Door Hinges

OE style reproduction replacement door hinges.

RDH-120UL	1968 Upper LH	39.95 ea.
RDH-120UR	1968 Upper RH	39.95 ea.
RDH-248LL	1968 Lower LH	49.95 ea.
RDH-248LR	1968 Lower RH	49.95 ea.



RDH-406UL

RDH-211LL

1969 Door Hinges

OE style reproduction replacement door hinges.

RDH-406UL	1969 Upper LH	45.95 ea.
RDH-406UR	1969 Upper RH	45.95 ea.
RDH-211LL	1969 Lower LH	49.95 ea.
RDH-211LR	1969 Lower RH	49.95 ea.
RDH-69FX-K	1969 4pc	172.62 kit



RDH-371UL



RDH-926L

1970-81 Door Hinges

OE style reproduction replacement door hinges.

RDH-371UL	1970-81 Upper LH	59.95 ea.
RDH-371UR	1970-81 Upper RH	59.95 ea.
RDH-926L	1970-81 Lower All	42.95 ea.

Quarter Panels

If your original quarter panels are dented or rotted right through to the ground, these exact reproduction quarter panels are the perfect replacement! There is no need to spend a fortune on an NOS quarter because this reproduction features a complete door jamb area, complete trunk jamb area and full roof sail panel. These are extremely high quality pieces, so you can be sure to get the best fit possible.

No Volume Discount. All quarter panels ship Truck Freight to a commercial address.



RFQ-67FL

- RFQ-67FL 1967 Coupe LH 349.95 ea.
- RFQ-67FR 1967 Coupe RH 349.95 ea.
- RFQ-67VL 1967 Convertible LH 339.95 ea.
- RFQ-67VR 1967 Convertible RH 339.95 ea.
- RFQ-68FL 1968 Coupe LH 349.95 ea.
- RFQ-68FR 1968 Coupe RH 349.95 ea.
- RFQ-68VL 1968 Convertible LH 339.95 ea.
- RFQ-68VR 1968 Convertible RH 339.95 ea.



RFQ-69FL

- RFQ-69FL 1969 Coupe LH 349.95 ea.
- RFQ-69FR 1969 Coupe RH 349.95 ea.
- RFQ-69VL 1969 Convertible LH 339.95 ea.
- RFQ-69VR 1969 Convertible RH 339.95 ea.



RFQ-70FL

- RFQ-70FL 1970-73 All LH 349.95 ea.
- RFQ-70FR 1970-73 All RH 349.95 ea.
- RFQ-74FL 1974 All LH 319.95 ea.
- RFQ-74FR 1974 All RH 319.95 ea.



RFQ-75FL

- RFQ-75FL 1975-81 All LH 319.95 ea.
- RFQ-75FR 1975-81 All RH 319.95 ea.



RQS-1067A

Quarter Panel Skins

These quarter panel repair skins offer a quick and inexpensive way to repair your original factory quarter panels without fully cutting them out. They extend from the upper belt line down. Fits all coupes and convertibles.

- RQS-1067A 1967-68 All LH 89.95 ea.
- RQS-1067B 1967-68 All RH 89.95 ea.
- RQS-1067C 1969 All LH 89.95 ea.
- RQS-1067D 1969 All RH 89.95 ea.
- RQS-F70L 1970-73 LH 109.95 ea.
- RQS-F70R 1970-73 RH 109.95 ea.
- RQS-F74L 1974-81 LH 109.95 ea.
- RQS-F74R 1974-81 RH 109.95 ea.

Side marker holes will have to be cut out for 1968 models. Ships Truck Freight to a commercial address.



4020-603-68L

80% Quarter Panels

These 80% quarter panels are very similar to our full quarter panels but lack the full door jamb section and roof sail panel area. These panels feature turn downs for rear window felts and extend into the trunk weatherstrip area. The rear curves back inward for easy installation of tail pan.

- 4020-603-67L 1967 All LH 119.95 ea.
- 4020-603-67R 1967 All RH 119.95 ea.
- 4020-603-68L 1968 All LH 119.95 ea.
- 4020-603-68R 1968 All RH 119.95 ea.
- 4020-603-69L 1969 All LH 119.95 ea.
- 4020-603-69R 1969 All RH 119.95 ea.

Ships Truck Freight to a commercial address.



RSP-976L RSP-976R

Quarter Trunk Opening Corner Stiffener Plate

This stiffener is welded to the quarter panel on the underside of the trunk lid opening and is commonly missing from previous repairs.

- RSP-975L 1967-68 LH 20.99 ea.
- RSP-975R 1967-68 RH 20.99 ea.
- RSP-976L 1969 LH 20.99 ea.
- RSP-976R 1969 RH 20.99 ea.



RBB-67B

Rear Bumper Bolt Reinforcement

This piece welds to the inside of the quarter panel and provides support for mounting the rear bumper bolt.

- RBB-67B 1967-68 LH/RH 2.95 ea.
- RBB-69B 1969 LH/RH 2.95 ea.

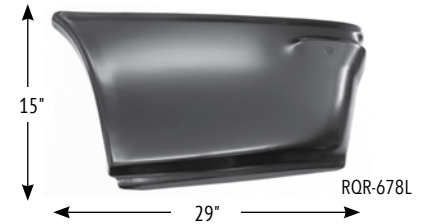

Quarter Panel Patches

Stamped steel quarter panel patches for repairing the commonly rusted out area behind the wheel opening.

- RQR-678L 1967-68 LH 15H x 29L 39.95 ea.
- RQR-678R 1967-68 RH 15H x 29L 39.95 ea.
- RQR-69L 1969 LH 12H x 25L 39.95 ea.
- RQR-69R 1969 RH 12H x 25L 39.95 ea.
- RQR-703L 1970-73 LH 15H x 31L 39.95 ea.
- RQR-703R 1970-73 RH 15H x 31L 39.95 ea.
- RQR-741L 1974-81 LH 17H x 21L 39.95 ea.
- RQR-741R 1974-81 RH 17H x 21L 39.95 ea.



RFP-654L

Quarter Window Rear Corner Filler

Supports the edge of the quarter panel where the window felt attaches. Often missing from previous quarter repair, this piece is essential to prevent stress cracks near the end of the drip rail.

- RFP-654L 1967-69 LH 14.99 ea.
- RFP-654R 1967-69 RH 14.99 ea.



RQD-1022

Quarter Panel & Door Frame Assembly

The massive piece of sheet metal includes the entire inner quarter panel and door structure as well as the windshield pillars, rocker panels and wheelhouses just as pictured. This saves you from the headache of fabricating your own pieces of metal.

- RQD-1021B 1967 All LH 999.95 ea.
- RQD-1021A 1967 All RH 999.95 ea.
- RQD-1023 1968 All LH 999.95 ea.
- RQD-1022 1968 All RH 999.95 ea.
- RQD-1023B 1969 All LH 999.95 ea.
- RQD-1023A 1969 All RH 999.95 ea.

Ships Truck Freight to a commercial address. No Volume Discount.



RWH-671L

Inner Wheelhouses

New inner rear section of wheelhouse which installs between the trunk area and seams to the outer wheelhouse. It is always a good idea to replace your wheelhouses when you replace your quarter panels!

RWH-671L	1967 LH	59.95 ea.
RWH-671R	1967-69 RH	59.95 ea.
RWH-681L	1968-69 LH	62.95 ea.
RWH-681K	1968-69 LH/RH.....	110.61 kit
RWH-701L	1970-81 LH.....	99.95 ea.
RWH-701R	1970-81 RH	99.95 ea.

Ships Oversize. No Volume Discount.



RWH-670TL

Outer Wheelhouses

Correct steel wheelhouses which attach to the inside of the quarter panel. It is always a good idea to replace your wheelhouses when you replace your quarter panels!

RWH-670TL	1967-68 LH	49.95 ea.
RWH-670TR	1967-68 RH	49.95 ea.
RWH-670K	1967-68 LH/RH.....	89.91 kit
RWH-690TL	1969 LH	39.99 ea.
RWH-690TR	1969 RH.....	39.99 ea.
RWH-690K	1969 LH/RH	67.98 kit
RWH-F700TL	1970-81 LH	64.95 ea.
RWH-F700TR	1970-81 RH	64.95 ea.
RWH-F700K	1970-81 LH/RH.....	103.92 kit

Ships Oversize. No Volume Discount.



DSE040401

DSE Deep Tubs

Detroit Speed & Engineering deep tubs are inner wheel housings designed to accommodate wider wheel and tire packages. They are engineered for a perfect fit, retain a stock appearance and are stamped from 18 gauge steel. They allow for 335mm tires and 13" wide tires. Made in USA.

DSE040401	1967-69 All	394.99 pr.
DSE040403	1970-81 All	484.99 pr.

Ships Oversize 2. No Volume Discount.

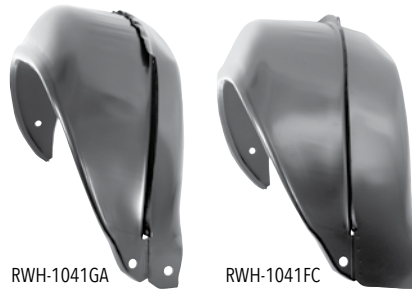

RWH-1041GA

RWH-1041FC

1969 Complete Wheelhouses

Complete wheelhouse assemblies which include the inners and outers already seamed together making installation much easier. Choose from 12.5" stock width or go for 15.25" width to fit larger wheels and tires.

RWH-1041GB	1969 LH 12.50"	129.95 ea.
RWH-1041GA	1969 RH 12.50"	129.95 ea.
RWH-1041GC*	1969 LH 15.25"	144.95 ea.
RWH-1041FC*	1969 RH 15.25"	144.95 ea.

Note: 12.50" standard size has 3-3/4" inner wheelhouse size. 15.25" wider size has 6" inner wheelhouse width.

**To be used in conjunction with RFP-1046AXWT or RFP-1046AGWT, RFR-1068SXWT and RFR-1068RXT.*

Ships Oversize 2. No Volume Discount.



RPB-69L

1967-69 Convertible Quarter Braces

High quality reproduction convertible quarter panel braces.

RPB-678L	1967-68 LH	169.95 ea.
RPB-678R	1967-68 RH	169.95 ea.
RPB-69L	1969 LH	169.95 ea.
RPB-69R	1969 RH	169.95 ea.



RWQ-1041HA

1970-81 Wheelhouse/Quarter Assembly

Full inner quarter panel structure with attached complete wheelhouse.

RWQ-1041JA	1970-81 LH.....	799.95 ea.
RWQ-1041HA	1970-81 RH	799.95 ea.
RWQ-1041JB	1970-81 LH w/o Outer Wheelhouse	109.95 ea.
RWQ-1041HB	1970-81 RH w/o Outer Wheelhouse	109.95 ea.

Ships Truck Freight to a commercial address. No Volume Discount.



RFB-1046E

Convertible Floor Pan Brace

This one piece brace installs horizontally under the floor for added strength for convertibles.

RFB-1046E	1967-69 Convertible.....	79.95 ea.
-----------	--------------------------	-----------

Ships Oversize



RPP-959

KPS-682L

1967-69 Door Jamb Area Patches

OE style replacement for this often rotted out area in the front of the rocker.

RPP-959	1967-69 LH Outer.....	79.99 ea.
RPP-958	1967-69 RH Outer	79.99 ea.
KPS-682L	1967-69 LH Inner	49.95 ea.
KPS-682R	1967-69 RH Inner.....	49.95 ea.



RIP-5970

RIP-1067R

Inner Rocker Panels Coupe

OE style reproduction die stamped inner rocker panels for an OE style replacement.

RIP-1067S	1967-69 Coupe LH.....	84.95 ea.
RIP-1067R	1967-69 Coupe RH	84.95 ea.
RIP-70L	1970-81 LH	89.99 ea.
RIP-70R	1970-81 RH	89.99 ea.
RIP-5970	1967-81 Drain Plugs.....	6.95 ea.

Ships Oversize



RRP-600L

Outer Rocker Panels Coupe

Correct gauge stamped steel full outer rocker panels with original mounting points.

RRP-600L	1967-69 Coupe LH.....	65.95 ea.
RRP-600R	1967-69 Coupe RH	65.95 ea.
RRP-700L	1970-81 All LH	82.95 ea.
RRP-700R	1970-81 All RH	82.95 ea.

Ships Oversize



RRP-9VL

Assembled Convertible Rocker Panels

Completely assembled rocker panel correctly stamped for an OE style replacement.

RRP-9VL	1967-69 Convertible LH	299.95 ea.
RRP-9VR	1967-69 Convertible RH	299.95 ea.

Ships Truck Freight to a Commercial Address. No Volume Discount.

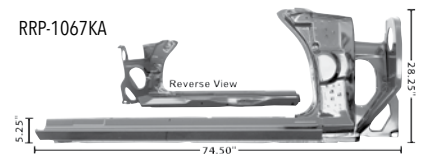

RRP-1067KA

1970-73 Complete Rocker Panels

These complete rocker panel assemblies include both inner rockers and outer rockers making installation much easier than welding together individual pieces.

RRP-1067KB	1970-73 LH	349.95 ea.
RRP-1067KA	1970-73 RH	349.95 ea.

Ships Truck Freight to a Commercial Address. No Volume Discount.

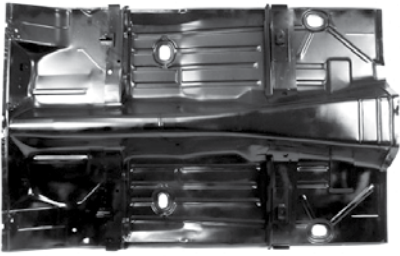

RFP-1046A

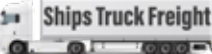

1967-69 Full Floor Pan

This full floor pan is the ultimate solution for your rotted out original floor! This piece features all correct subframe/seat mounting brackets with caged nuts and rear seat mounting brackets. This is the same floor pan we have used on all of our own Camaro projects!

- RFP-1046A 1967-69 All299.95 ea.
 - RFP-1046AX 1967-69 w/ 6 Inch Cutouts*404.95 ea.
- *To be used in conjunction with RFR-1068SXWT, RFR-1068RXT, RWH-1041GC and RWH-1041FC.*

No Volume Discount. Ships Truck Freight to a commercial address.

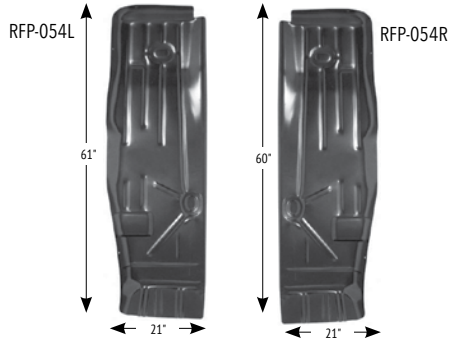

Half Side Floor Pans

Full half side floor panels which seam in the middle. Complete with partial toe board (Exc. 70-81)

- RFP-054L 1967-69 LH, 61" X 21"49.95 ea.
 - RFP-054R 1967-69 RH, 60" X 20"49.95 ea.
 - RFP-089L 1970-81 LH, 57" X 22"*79.95 ea.
 - RFP-089R 1970-81 RH, 57" X 22"*79.95 ea.
- Ships Oversize 2. * 1975-81 may require modification to fit.*



RFP-054L-TNL

RFP-054R-TNL

1967-81 Half Side Floor Pan

Full half side floor pans complete with partial transmission tunnel. 1970-81 come with partial toe board.

- RFP-054L-TNL 1967-69 25" X 62" LH 1/285.95 ea.
 - RFP-054R-TNL 1967-69 25" X 62" RH 1/285.95 ea.
 - RFP-089L-TNL 1970-74 27" X 62" LH 1/2109.95 ea.
 - RFP-089R-TNL 1970-74 27" X 62" RH 1/2109.95 ea.
 - RFP-75L-TNL 1975-81 27" X 61" LH 1/2139.95 ea.
 - RFP-75R-TNL 1975-81 27" X 61" RH 1/2139.95 ea.
- The 1/2 Sections Ship Truck freight.*

Floor Pan Patches

These patches are perfect when only small portions of your floor pan have rusted out.

Front

- RFP-67FL 1967-69 21" x 40" LH49.95 ea.
- RFP-67FR 1967-69 20" x 39" RH49.95 ea.
- RFP-70FL 1970-81 37" x 22" LH*89.95 ea.
- RFP-70FR 1970-81 36" x 22" RH*89.95 ea.

Rear

- RFP-67RL 1967-69 21" x 20" LH45.95 ea.
- RFP-67RR 1967-69 21" x 20" RH45.95 ea.
- RFP-70RL 1970-81 21" x 22" LH*69.95 ea.
- RFP-70RR 1970-81 21" x 22" RH*69.95 ea.

Ships Oversize 1975-81 may require modification to fit.*

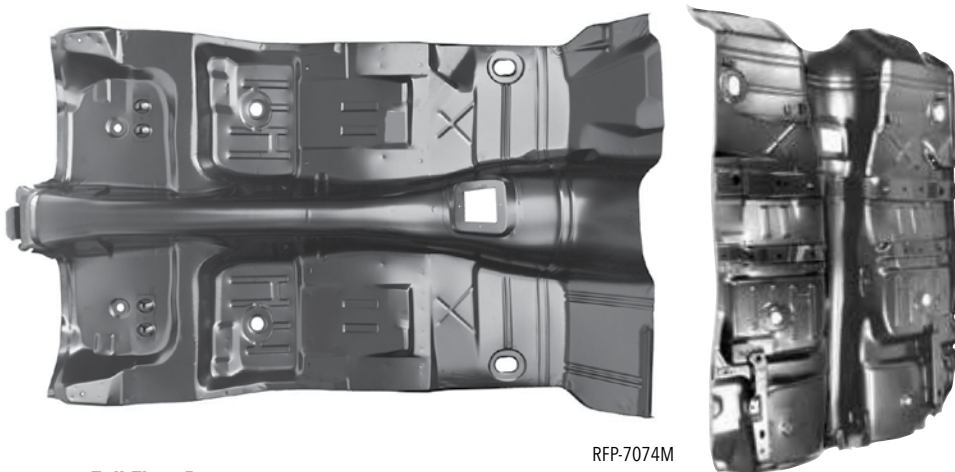
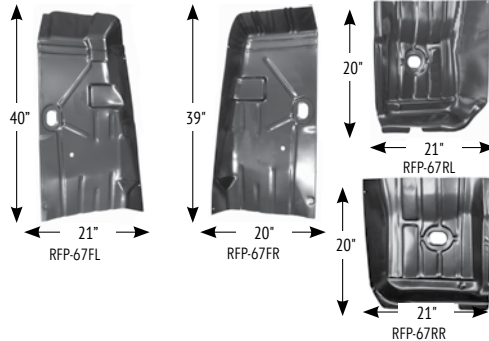

RFP-7074M

1970-81 Full Floor Pan

This full floor pan is available either with or without the braces already installed. Using this new complete floor pan to replace your rotted out floor will save you hours of time and money.

- RFP-1046 Camaro/Firebird 70-73 Full Floor Pan Assy. (All w/o Cutout) w/o Braces, w/o Parking Brake Cable Cover. (Please Note: This Does Not Come with The Torque Box Braces.).....319.95 ea.
- RFP-1045Z Camaro/Firebird 70-74 Manual Trans Floor Assy OE Type (w/ Floor Braces, Torque Boxes & Transmission Hump) AMD619.95 ea.
- RFP-7074A Camaro/Firebird Floor Pan Full OE 70-74 Full Floor Panel, Auto Trans, (w/ Center Braces & Rear Torque Box Braces, Also Includes Toe Board Area), 70-74 Cam/FB.....569.95 ea.
- RFP-7074M Camaro/Firebird Floor Pan Full OE 70-74 w/ Manual Trans Full Floor Panel, Manual Trans, (w/ Center Braces & Rear Torque Box Braces, Also Includes Toe Board Area), 70-74 Cam/FB.....599.95 ea.
- RFP-7581A Camaro/Firebird 75-81 Auto Trans Floor Assy -OE Type (w/ Floor Braces & Torque Boxes).....569.95 ea.
- RFP-7581M Camaro/Firebird 75-81 Manual Trans Floor Assy -OE Type (w/ Floor Braces, Torque Boxes & Transmission Hump)569.95 ea.

No Volume Discount. Ships Truck Freight to a commercial address.

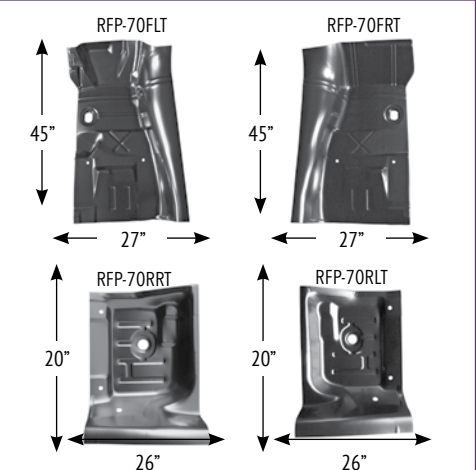

1970-81 Quarter Floor Pans

Quarter floor pans complete with toe board and partial transmission tunnel.

- RFP-70FLT 1970-74 27" X 45" LH Front 1/4 ...79.95 ea.
- RFP-70FRT 1970-74 27" X 45" RH Front 1/4 ...79.95 ea.
- RFP-70RLT 1970-74 26" X 20" LH Rear 1/449.95 ea.
- RFP-70RRT 1970-74 26" X 20" RH Rear 1/449.95 ea.
- RFP-75FLT 1975-81 27" X 44" LH Front 1/4 ...99.95 ea.
- RFP-75FRT 1975-81 27" X 44" RH Front 1/4 ...99.95 ea.
- RFP-75RLT 1975-81 26" X 20" LH Rear 1/449.95 ea.
- RFP-75RRT 1975-81 26" X 20" RH Rear 1/449.95 ea.

Ships Oversize 2.



RTB-126OEL

Toe Boards

These complete factory style extensions connect the front floor pan to the firewall.

RTB-126OEL	1967-69 LH.....	49.95 ea.
RTB-126OER	1967-69 RH.....	49.95 ea.
RTB-F70	1970-81 Complete*.....	199.95 ea.
RTB-70FL	1970-81 LH.....	89.95 ea.
RTB-70FR	1970-81 RH.....	89.95 ea.

*Ships Oversize 2.



MCB-60

Convertible Floor Pan Cross Brace

OE style reproduction stamped steel transmission tunnel brace for under floor pan.

MCB-60	1967-69.....	89.95 ea.
MCB-BOLT	Bolt Kit 6pc.....	5.95 kit



RFB-1046K

RFB-1046J

Front Floor Pan Braces

Stamped steel braces for the front section of the floor pan.

RFB-1046J	1967-69 Convertible RH.....	49.95 ea.
RFB-1046K	1967-69 Convertible LH.....	49.95 ea.



RFB-1075H

1970-81 Floor Pan Braces

OE style reproduction braces for under the floor pan. Complete 3 piece kit.

RFB-1075H	1970-74 All.....	169.95 ea.
RFB-75K	1975-81 All.....	169.95 kit

Ships Oversize



IBX-679F

Rear Seat Floor Hook

Correct hook for rear seat which mounts to the floor pan. Two required per car.

IBX-679F	Most GM Cars.....	7.95 ea.
----------	-------------------	----------



Seat Frame Supports

Correct seat frame supports which attach to the front seat floor brackets.

RSB-1051	1967-69 Coupe LH.....	54.95 ea.
RSB-1050	1967-69 Coupe RH.....	54.95 ea.
RSB-1050K	Coupe LH/RH.....	98.91 kit
RSB-1052B	1967-69 Convertible LH.....	59.95 ea.
RSB-1052A	1967-69 Convertible RH.....	59.95 ea.
RSB-1050VK	Convertible LH/RH.....	107.91 kit



Front Seat Brackets

Correct front seat mounting brackets which spot weld to the floor and also support the rear of the subframe.

RSB-1052L	1967-69 LH.....	39.95 ea.
RSB-1052R	1967-69 RH.....	39.95 ea.



Rear Seat Brackets

Correct rear seat mounting brackets which spot weld to the floor to support the bottom of the rear seat.

RSB-1053L	1967-69 LH.....	36.95 ea.
RSB-1053R	1967-69 RH.....	36.95 ea.



RMP-1001



RMP-1001A

Rear Seat Divider Panel

This is the horizontal divider panel that installs between the rear seat and trunk area and retains the rear seat.

RMP-1001	1967-69 Convertible.....	224.95 ea.
RMP-1001A	1970-73 All.....	224.95 ea.

Ships Oversize

RSB-70FRL



Under Rear Seat Brace (Torque Box)

Welds onto the floor under the rear seat and provides the mounting point for the leaf spring perch bolt.

RSB-67FRL	1967-69 LH.....	49.95 ea.
RSB-67FRR	1967-69 RH.....	49.95 ea.
RSB-70FRL	1970-81 LH.....	79.96 ea.
RSB-70FRR	1970-81 RH.....	79.95 ea.

No Volume Discount



RSB-70L

1967-81 Rear Seat Floor Pan

Correct rear under seat floor pans.

RSP-679	1967-69 Complete All LH & RH 1pc*.....	69.95 ea.
RSP-679L	1967-69 LH All.....	34.95 ea.
RSP-679R	1967-69 RH All.....	34.95 ea.
RSP-70L	1970-81 LH.....	79.95 ea.
RSP-70R	1970-81 RH.....	79.95 ea.

*Ships Oversize 2.



RFR-7L

Full Frame Rails

OE style reproduction full frame rail to replace your rotted original.

RFR-7L	1967 LH.....	169.99 ea.
RFR-7R	1967 RH.....	169.99 ea.
RFR-11L	1968-69 LH.....	134.95 ea.
RFR-11R	1968-69 RH.....	134.95 ea.
RFR-1068SXWT	1968-69 6" Wider LH*.....	219.95 ea.
RFR-1068RXWT	1968-69 6" Wider RH*.....	219.95 ea.
RFR-22L	1970-73 LH.....	219.99 ea.
RFR-22R	1970-73 RH.....	219.99 ea.

*To be used in conjunction with RFP-1046AXWT or RFP-1046AGWT, RWH-1041GC and RWH-1041FC.

Ships Oversize 2



RFR-43L

Rear Frame Rail Repair

These are replacement partial frame rails which are perfect for replacing the rear section. This section measures 45" from the rear shackle forward and includes stamped holes to mount the shackle.

RFR-47L	1967 LH.....	158.95 ea.
RFR-47R	1967 RH.....	158.95 ea.
RFR-48L	1968-69 LH.....	149.95 ea.
RFR-48R	1968-69 RH.....	149.95 ea.
RFR-43L	1970-73 LH.....	189.95 ea.
RFR-43R	1970-73 RH.....	189.95 ea.
RFR-81L	1974-81 LH.....	194.95 ea.
RFR-81R	1974-81 RH.....	194.95 ea.

Ships Oversize 2



Installed

Wiring Harness Shield Kit

Correct galvanized steel shields which attach to the rocker panels in order to protect the wiring harness.

RWS-1008	1967-69 All 4pc.....	109.95 set
----------	----------------------	------------



RSF-69F

RSF-69F Detail

1967-69 OEM Style Sub Frame

OEM style subframe which is an OE style replacement for your rusty, dented or bent original. There is no longer any need to waste money trying to repair your damaged original subframe. This subframe features factory style welds for an OEM appearance, extra bracing in the lower crossmember to add strength while jacking the car (but completely invisible on the outside) and holes and brackets as original. This subframe is very hard to tell from OEM due to all of these correct details.

RSF-67F	19671139.99 ea.
RSF-68F	19681139.99 ea.
RSF-69F	19691139.99 ea.

No Volume Discount. Ships Truck Freight to a commercial address.



RST-67F

Shifter Tunnel Repair Plate

This piece allows you to repair the often hacked up shifter tunnel area without having to replace the whole floor.

RST-67F	1967-69 All69.99 ea.
RST-703	1970-81 All39.95 ea.

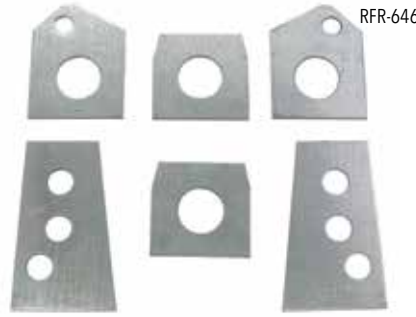

RFR-646

Sub Frame Repair Plates

Stamped steel plates for repairing your rusted or damaged sub frame mounting points. Complete set of (6) includes radiator support.

RFR-646	1967-81*56.99 kit
---------	----------	----------------

*Modifications will be required to fit 70-81 applications.

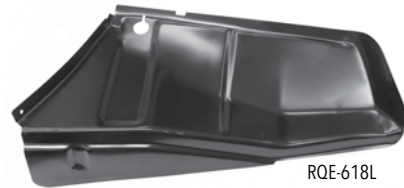

RQE-618L

Trunk Drop Offs

These die stamped drop offs connect the inside lower rear of the quarter panel to the outside of the trunk.

RQE-618L	1967-68 LH29.95 ea.
RQE-618R	1967-68 RH29.95 ea.
RQE-619L	1969 LH29.95 ea.
RQE-619R	1969 RH29.95 ea.
RQE-703L	1970-73 LH49.95 ea.
RQE-703R	1970-73 RH49.95 ea.
RQE-74L	1974-81 LH49.95 ea.
RQE-74R	1974-81 RH49.95 ea.



RST-679R

Rear Shock Tower Patch

New shock tower repair sections.

RST-679R	1967-69 RH32.99 ea.
RST-67L	1967 LH32.99 ea.
RST-679L	1968-69 LH32.99 ea.



RDP-100

RDP-7488

Trunk/Floor Pan Drain Plug

Correct die stamped floor drain plug.

RDP-100	1967-73 All3.95 ea.
RDP-7488	1974-88 All13.99 ea.



RTF-1046B



Full One Piece Trunk Floor Pans

Like our full floor pans, these trunk floors will save you hours of labor costs and ease to the installation because they include side extensions, trunk to rear body panel braces, fuel tank braces and bumper mounting brackets. These floors truly are complete!

RTF-1046B	1967 w/o Staggered Shocks310.95 ea.
RTF-1046D	1968 w/ Staggered Shocks310.95 ea.
RTF-1046C	1969 All310.95 ea.
RTF-1046CX	1969 w/ Mini Tubes399.95 ea.
RTF-1048Z	1970-73 All299.95 ea.
RTF-7481F	1974-81 All359.95 ea.

No Volume Discount. Ships Truck Freight to a commercial address.



RTF-6782

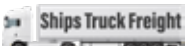

Center Trunk Floor Pans

Correct die stamped center trunk floor pans are perfect when only the center is rusted out.

RTF-6782	1967-68 45W x 38L79.95 ea.
RTF-692	1969 47W x 38L79.95 ea.
RTF-703	1970-73 42W x 37L119.95 ea.
RTF-7481	1974-81 42W x 69L169.95 ea.

Ships Truck Freight to a commercial address.



RTF-69C

Center Trunk Floor Patch

Slightly smaller than the center pans above, these patches can be shipped via ground and do not have to ship truck freight.

RTF-678C	1967-68 44W x 35L75.95 ea.
RTF-69C	1969 44W x 35L69.95 ea.

Ships UPS Oversize 2



RTF-7481F

1974-1981 Camaro Full One Piece Trunk Floor w/ Brackets, Braces

Like our full floor pan, this Camaro full trunk floor pan is a one piece unit that will save you hours of labor costs and installation difficulty over piecing together individual components. This trunk pan features side extensions, trunk to rear body panel braces, fuel tank braces, and bumper mounting brackets.

RTF-7481F 1974-81* 359.95 ea.

*Does Not Come with Frame Rails.

No Volume Discount. Ships Truck Freight to a commercial address.



RTE-678L

RTE-69R

Trunk Floor Extensions

Die stamped panels which extend from the trunk floor to the quarter panel drop offs.

RTE-678L	1967-68 LH.....	55.99 ea.
RTE-678R	1967-68 RH.....	55.99 ea.
RTE-69L	1969 LH.....	55.99 ea.
RTE-69R	1969 RH.....	55.99 ea.



RTF-74



RTF-679

RTF-1058

Trunk Floor/Fuel Tank Braces

Correct braces which attach to the trunk floor and support the fuel tank straps.

RTF-679	1967-68 LH & RH.....	39.95 ea.
RTB-69L	1969 LH.....	39.95 ea.
RTB-69R	1969 RH.....	39.95 ea.
RTF-1058	1970-73 4pc.....	119.95 ea.
RTF-74	1974-81 4pc.....	119.95 set

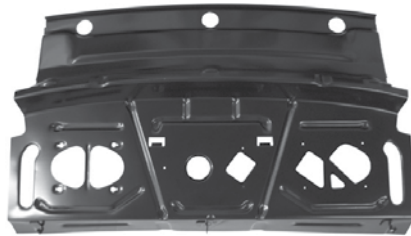

RDP-67

Package Shelf Repair Panel

This is the piece of metal which is located underneath the rear deck package shelf (speaker panel) and under the rear window to trunk panel. This piece will prevent the hassle of hand fabricating a repair panel for this common rust area.

RDP-67	1967 All.....	125.95 ea.
RDP-689	1968-69 All.....	169.95 ea.
RDP-703	1970-73.....	195.95 ea.

Ships Oversize 2. No Volume Discount.

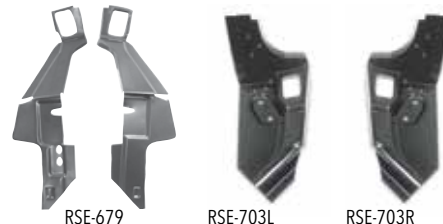

RSE-679

RSE-703L

RSE-703R

Package Shelf Extensions

OE style reproduction package shelf extension pieces. A great fix for these commonly rotted out areas!

RSE-679	1967-69.....	49.95 pr.
RSE-703L	1970-73 LH.....	39.95 ea.
RSE-703R	1970-73 RH.....	39.95 ea.



RSB-1001D

Rear Seat Back Braces

OE style reproduction die stamped braces to support your rear seat.

RSB-1001D	1967-69.....	64.95 pr.
-----------	--------------	-----------

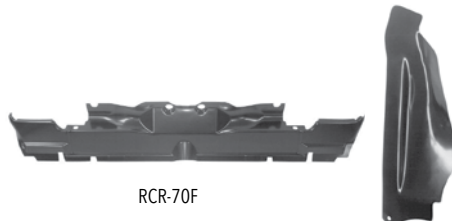

RCR-70F

RCR-70FL

Rear Cross Rail & Extensions

Correct rear cross rail which is located behind the rear tail light panel. Constructed out of heavy gauge steel as original and EDP coated for rust prevention.

RCR-70F	1970-73 Rear Cross Rail.....	79.95 ea.
RRE-70FL	1970-73 Rear Cross Rail Ext LH.....	23.95 ea.
RRE-70FR	1970-73 Rear Cross Rail Ext RH.....	23.95 ea.
RFR-74F	1974-81 Rear Cross Rail.....	84.95 ea.

Ships Oversize.



RTL-679

Trunk Lids

OE style reproduction of the often rotted or damaged trunk lid.

RTL-679	1967-69 All w/o Spoiler Holes.....	109.95 ea.
RTL-679SP	1967-69 All w/ Pre-Drilled Holes.....	124.95 ea.
RTL-701	1970-81 All w/o Spoiler Holes.....	119.95 ea.
RTL-70SP	1970-81 All w/ Pre-Drilled Holes.....	134.95 ea.

No Volume Discount. Ships Oversize 2.



RWP-1075

OE Style Rear Window to Trunk Panel

This is a correct OE style rear window to trunk panel featuring the inner lip area located inside the rear window above the rear seat.

RWP-1075	1967-69 Coupe.....	72.95 ea.
----------	--------------------	-----------

Ships Oversize.



RWP-679



RWP-70L

Rear Window to Trunk Panel

Reproduction stamped steel panel which fits between the rear window and the trunk lid.

RWP-679	1967-69 Coupe.....	44.95 ea.
RWP-679C	1967-69 Convertible.....	69.95 ea.
RWP-701	1970-73 Outer.....	39.95 ea.
RWP-70L	1970-81 Inner.....	74.95 ea.

Ships Oversize.



RTG-67F

Weatherstrip Gutter

New three piece trunk weatherstrip gutter which is required when replacing your quarters.

RTG-67F	1967-69 3pc.....	49.95 set
RTG-70F	1970-81 2pc.....	66.99 pr.



RTL-1019



RTL-7081

Trunk Lid Latch

OE style reproduction of the often damaged or missing trunk latching device.

RTL-1019	1967-69	29.95 ea.
RTL-7081	1970-81	29.95 ea.



RTC-1067ZA

Trunk Lid Catch

OE style replacement. Originally painted body color.

RTC-1067ZA	1967-69 ALL	18.95 ea.
TLB-716	1967-81 5pc Bolts	8.95 set

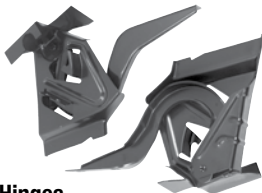

RTH-1049LA

Trunk Hinges

OE style reproduction trunk hinges to replace your damaged originals.

RTH-1049LA	1967-69 All	145.95 pr.
RTH-7081L	1970-81 LH	85.99 ea.
RTH-7081R	1970-81 RH	85.99 ea.



P-2000

Spare Tire Anchor Plates

Correct spare tire hold down and jack floor brackets.

P-2000	1967-69 Anchor Plate	9.95 ea.
--------	----------------------------	----------



RLS-693

Trunk Lid Spring with Sleeve

Correct right side torsion rod and heavy spring used on all models with rear spoiler. Includes heavy molded rubber sleeve. Can also be used on models without rear deck lid spoiler.

RLS-693	1967-69	29.99 ea.
---------	---------------	-----------

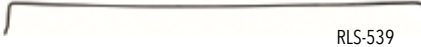

RLS-539

1970-81 Trunk Hinge Torque Rod

Reproduction trunk hinge torque rod manufactured as original from precision bent steel. Designed to hold the trunk lid up when open.

RLS-539	1970-81 LH	24.99 ea.
RLS-538	1970-81 RH w/o Spoiler	24.99 ea.
RLS-540	1970-81 RH w/ Spoiler	24.99 ea.



RTB-1067X

Trunk Torsion Bracket

Correct trunk lid support bracket which the trunk lid bolts to. This piece welds to the body of the car. Complete with tension spring bars.

RTB-1067X	1967-69 Convertible	239.95 ea.
-----------	---------------------------	------------

Ships Oversize



MS149-05M

Eddie Motorsports Billet Trunk Hinges

M = Machined, P = Polished, CA = Clear Anodized, B = Blue, PR = Purple, R = Red, BKA = Gloss Black, MBA = Matte Black
 WILL NOT WORK ON CONVERTIBLES

	<u>M</u>	<u>P</u>	<u>All Others</u>
MS149-05_	1967-69	315.99 pr. ..	340.99 pr.
MS149-06_	1970-81	219.99 pr. ..	240.99 pr.



R-1067W

R-1067Z

RTB-1067V

Rear Inner Panel Braces

Correct center of inner panel braces which attach to the inner tail light panel for the trunk latch.

R-1067Z	1967-68 All	39.95 ea.
R-1067W	1969 All	39.95 ea.
RTB-1067V	1970-73 All	54.95 ea.



RTB-4

RTB-3

RTB-1

Trunk Floor Tail Panel Braces

These OE style reproduction braces extend from the rear trunk pan to the tail panel for rear bumper mounting.

RTB-3	1967-68 Large Inner	22.99 ea.
RTB-4	1969 Large Inner	39.99 pr.
RTB-1	1969 Small Corner	24.99 pr.

REP-678



REP-69



REP-703



Rear End Tail Panels

Complete rear panels which extend above and below the rear bumper and from right to left quarter panels.

REP-678	1967-68 Standard	99.95 ea.
REP-678RS	1967-68 RS w/ Pre-Cut Holes	95.95 ea.
REP-69	1969 All	109.95 ea.
REP-69-RS	1969 RS w/ Pre-Cut Holes	119.95 ea.
REP-703	1970-73 All	99.95 ea.

Ships Oversize 2.



RIP-678



RIP-678RS



RIR-1067



RIP-74



RIP-781

Rear Inner Panels

Stamped rear inner panel. 1967-69 installs behind the rear end tail panel and 1974-81 installs behind the urethane bumper cover.

RIP-678	1967-68 Standard.....	69.95 ea.
RIP-678RS	1967-68 RS w/ Pre-cut Holes	99.95 ea.
RIR-1067	1969 All	75.95 ea.
RIP-74	1974-77 All	74.95 ea.
RIP-781	1978-81 All	74.95 ea.

Ships Oversize 2.



RTP-703



RTP-741

Lower Tail Panel Patch

Die stamped steel lower tail panel patches which are perfect when only the lower section of your tail panel is rotted.

RTP-703	1970-73 Approx 9" Tall	49.95 ea.
RTP-741	1974-81 Approx 5" Tall	49.95 ea.

Ships Oversize.



CT-727 Detail

RS Reverse Lens Mounting Template

Correct template which shows the tail panel hole locations for the RS backup lamp housings.

CT-724	1967-68 RS	34.99 ea.
CT-727	1969 RS	34.99 ea.



Roof Panel

Excellent reproduction roof panel skin which will replace your rotted out original exactly. 1970-73 comes with or without A-pillars installed.

RA00003	1967-69 All	259.95 ea.
RA7074	1970-74 All	339.95 ea.
RP-7073F	1970-73 w/ A-Pillars.....	749.95 ea.
RP-1004K	1975-81	349.95 ea.

Ships Truck Freight to a commercial address.



RBK-1A



RBK-1B

Roof Panel Braces

Complete set of roof panel reinforcement braces. A must when replacing your roof panel!

RBK-1A	1967-68 7pc.....	199.95 ea.
RBK-1B	1969 14pc.....	199.95 ea.

Ships Oversize 2



KPR-106A

Drip Rail Support

Correct metal support that runs along the edge of the roof and retains the drip rail. This support is painted body color.

KPR-107A	1967-69 LH.....	89.95 ea.
KPR-106A	1967-69 RH	89.95 ea.

Ships Oversize 2



KPR-106

Pillar Drip Rail Support

Correct metal support that runs along the edge of the A-pillar and retains the drip rail. This support is painted body color.

KPR-107	1967-69 LH.....	49.95 ea.
KPR-106	1967-69 RH	49.95 ea.
KRP-756	1970-81 Rear of Door	49.99 pr.



MCT-1000



RPS-1000A

Convertible Top Frame

This high quality reproduction steel convertible top frame is complete with fully reinforced hinge mechanisms along with everything you need to complete this rusted out frame. Designed for power top models.

MCT-1000	1967-69 Convertible Frame.....	999.95 ea.
RPS-1000A	1967-69 B-Pillar Supports	89.95 pr.

Ships Truck Freight to a commercial address. No Volume Discount.



RRC-69

Roof Weatherstrip Channel

High luster stainless steel like original. Bolts onto the roof channel to retain the roof rail weatherstrip.

RRC-67F	1967 Coupe 6pc	199.95 kit
RRC-69	1968-69 Coupe 6pc	199.95 kit

This item ships Oversize. No volume discount.

BUY 'N SAVE
WITH KITS

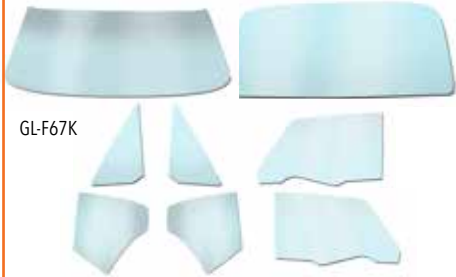

GL-F67K

Complete Glass Kits

Save when you buy a complete set of replacement window glass!

GL-F67K	1967 Coupe 8pc	599.99 kit
GL-F67VK	1967 Convertible 7pc	564.99 kit
GL-F69K	1968-69 Coupe 6pc	475.99 kit
GL-F69VK	1968-69 Convertible 5pc	577.99 kit
GL-70FK	1970-74 All 4pc	539.99 kit
GL-75FK	1975-81 All 4pc	693.99 kit

No Volume Discount. Ships Truck Freight to a Commercial Address.



Windshield Glass

Concourse quality tinted windshield glass for an OE style factory replacement.

GL-67FF	1967-69 Coupe	141.99 ea.
GL-67VFF	1967-69 Conv.	158.99 ea.
GL-70FF	1970-81 All	157.99 ea.

No Volume Discount. Ships Oversize 2



Rear Window Glass

Concourse quality tinted rear window glass for an OE style factory replacement.

GL-67FR	1967-69 Coupe	142.99 ea.
GL-70FR	1970-74 All	247.99 ea.
GL-75FR	1975-81 All	257.99 ea.

Ships Oversize 2



Door Window Glass

Concourse quality tinted door window glass for an OE style factory replacement.

GL-67FDL	1967 LH	114.99 ea.
GL-67FDR	1967 RH	114.99 ea.
GL-68FDL	1968-69 LH	114.99 ea.
GL-68FDR	1968-69 RH	114.99 ea.
GL-70FDL	1970-81 LH	126.99 ea.
GL-70FDR	1970-81 RH	126.99 ea.

Ships Oversize.

Glass comes standard in green tint. Clear & Smoke Grey are available. Please contact our sales team for more information.



Vent Window Glass

Concourse quality tinted 1967 only vent window glass for an OE style factory replacement.

GL-67FVL	1967 LH	74.99 ea.
GL-67FVR	1967 RH	74.99 ea.

Ships Oversize.



Quarter Window Glass

Concourse quality tinted quarter window glass for an OE style factory replacement.

GL-67FQL	1967-69 Coupe LH	75.99 ea.
GL-67FQR	1967-69 Coupe RH	75.99 ea.
GL-67FVQL	1967-69 Conv. LH	75.99 ea.
GL-67FVQR	1967-69 Conv. RH	75.99 ea.

Ships Oversize.



1967-69 Glass Assemblies Clear

Complete glass assemblies with the glass and hardware.

GDA-689FL	1968-69 LH Front All	339.95 ea.
GDA-689FR	1968-69 RH Front All	339.95 ea.
GDA-67RLC	1967-69 LH Rear Coupe	199.95 ea.
GDA-67RRC	1967-69 RH Rear Coupe	199.95 ea.
GDA-67RLV	1967-69 LH Rear Conv.	199.95 ea.
GDA-67RRV	1967-69 RH Rear Conv.	199.95 ea.

Ships Oversize 2



Date Coding Service

Ground Up is proud to offer custom glass date coding service on our glass pieces for the serious restorer! Our research shows that glass was usually dated 8-10 weeks prior to the build date of the car. Please supply your sales rep with your desired date and allow 2-4 weeks for delivery. All date coded glass is non-returnable and is not eligible for discounting.

GLASS-DATE	Coding Service	249.99 ea.
------------	----------------------	------------



RW-679-F-REAR

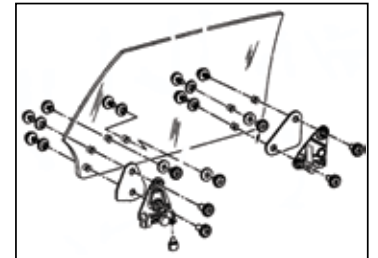

1968-69 Complete Door Glass Mounting Plate & Hardware Kit

Everything you need to fully mount both RH and LH front door glass. This complete 68 piece kit includes: (1) RH Door Glass Front & Rear Mount Plate Set, (1) LH Door Glass Front & Rear Mount Plate Set, (2) Door Glass Plate Gasket Sets, (6) Front & Rear Glass Plate Mount Stud Assemblies, (2) Rear Glass Plate Mounts & Nuts, (2) Forward Door Glass Stop Bumper Assemblies, (4) Window Sash Retaining Nuts

RW-050	1968-69 All	209.99 kit
RW-6-AFX	1967 Front All	33.95 kit
RW-689-F	1968-69 Front All	59.95 kit
RW-679-F-REAR	1967-69 Rear All	64.95 kit
RW-7081F	1970-81 Front All	229.99 kit



KW-648

Windshield Glass Stop

OE style reproduction windshield glass stop clip rubber coated as original. Two required.

KW-648	1967-69 All	6.99 ea.
KW-995	1970-81 All	12.99 ea.



RWS-075

Front Door Window Lower Stop

Plated stamped steel stop with rubber coated tip for forward front window. One required per door.

GGS-548	1967	13.99 pr.
RWS-075	1968-69	6.99 ea.
RWS-063	1970-81	6.99 ea.



T-TOP-9302

T-Top Assemblies

This is pair of brand new, complete T-Top assemblies complete with glass, molding, and weather strip made by the OEM manufacturer. Sold as a pair. Also fits Firebird.

T-TOP-8692	1986-92 All	995.95 pr.
T-TOP-9302	1993-02 All	995.95 pr.

No volume discount.



GWR-740



GWR-744

1970-81 Door Glass Roller Washers

GWR-740	Roller Washer Pear Shape.....	5.99 ea.
GWR-741	Roller Washer Round.....	5.99 ea.
GWR-742	Roller Washer Gasket Plastic.....	5.99 ea.
GWR-743	Roller Washer Gasket Rubber.....	5.99 ea.
GWR-744	Roller Nut.....	5.99 ea.
GWR-745	Roller Sash Stud/Washer.....	11.99 ea.



GG5-059

1967-69 Door Glass Stops

OE style reproduction cast metal stops limit the travel of the RH or LH door glass. These stops fasten to the rearward door glass window track. Mounting hardware is not included.

GG5-548	1967 Front & Rear.....	13.99 pr.
GG5-059	1968-69 Rear.....	36.99 pr.

These kits do one door.



7698543



7698542

1968-69 Inner Door Panel Retainer/Window Guide

Used to support the inner door panels and includes the felt pad used to guide the window when rolling up or down.

7698543	1968-69 Front.....	18.99 ea.
7698542	1968-69 Rear.....	19.99 ea.

Note: 2 fronts and 2 rears required per car.



Door Window Track Upper Plate

Zinc plated stamped steel plate for mounting the rear door window track. Replaces the often bent or missing originals, and allows mounting of the rear track and proper window alignment.

RWT-252	1968-69 All LH & RH.....	8.99 ea.
---------	--------------------------	----------



IDH-181

Door Hardware Mounting Kits

Correct Camaro door hardware for mounting door opening mechanism, door latch, window tracks, upper glass sash, inner sash and door opening rod guide bracket. One kit required per door. Fits either LH or RH.

IDH-181	1967 All 20pc.....	16.99 kit
IDH-182	1968-69 All 27pc.....	19.99 kit
IDH-183	1970-81 All 25pc.....	21.99 kit



IRP-685



IRP-760

1970-81 Inner Door Panel Retainer Plate

Used to support inner door panels. Center/rear includes correct felt padding

IRP-685	1970-78 Forward Plate.....	16.99 ea.
IRP-760	1970-79 Center/Rear Retainer.....	16.99 ea.



IVH-733

1967 Vent Window

Vent window pivot stud and handle kit includes: two reproduction vent window stud assemblies with polished stainless caps, two fiber gaskets, two rubber gaskets, two internal plastic bushing spacers, four special wave washers (2 extra). RH and LH vent window chrome die cast handles with roll pins.

IVH-733	Pivot Stud & Handle Kit.....	79.99 kit
IVH-67	Handles Only.....	39.95 pr.
IVH-741	Pivot Stud Assembly Only.....	20.99 kit
IVH-742	Pivot Stud Nut Chrome.....	5.99 ea.

Pieces also available separately.



GWP-051



Door Window Plate & Roller Set

Correct reproduction galvanized front and rear door glass mounting plates with roller assemblies. Front rubber stop included.

GWP-051	1968-69 All RH.....	57.99 set
GWP-052	1968-69 All LH.....	57.99 set



GPG-053



Window Plate Gasket Set

Correct die cut gaskets for front and rear plates of one door glass. Two sets required per car.

GPG-053	1968-69 All.....	8.99 pr.
---------	------------------	----------



GMS-054

Door Glass Plate Mount Stud Assembly

Three required per glass. Two for front plate and one for rear.

GMS-054	1968-69 All.....	8.99 ea.
---------	------------------	----------



GSM-055

Rear Door Glass Stop Mount & Nut

One required per door glass. Coated bumper stud with nut.

GSM-055	1968-69 All.....	7.99 ea.
---------	------------------	----------



GBA-056

Forward Door Glass Stop Bumper Assembly

Blue coated bumper stop stud with nylon bushing washer and steel nut. One required per door glass.

GBA-056	1968-69 All.....	9.99 ea.
---------	------------------	----------



GG5-703F

Window Guides & Stops

Correct set of door glass guides and stops.

GG5-703F	1970-75.....	42.95 kit
----------	--------------	-----------



GSM-023



1970-81 Door Glass Stop Bumpers

A must when replacing door glass. These stops are often so brittle that they can be removed but not re-installed. These hard plastic bumpers are required for proper door glass alignment.

GSM-023	1970-81 All.....	9.99 pr.
---------	------------------	----------



GWR-060

1967-69 Quarter Window Roller Assembly

Complete window roller assembly for rear quarter window including center lower guide roller and threaded stud assembly.

GWR-060	Assembly.....	12.99 ea.
WR-76	Roller Only.....	8.95 ea.
GWR-060A	Washer Only.....	6.95 ea.
GWR-060B	Nylon Bushing.....	5.99 ea.



GSA-057

Door Glass Sash Mount Stud Assembly

Stud bolt, nylon bushing and backing washers and special steel washer nut. This is used to mount the lower glass sash channel to door glass. Two required per door glass.

GSA-057	1968-69 All.....	9.99 ea.
---------	------------------	----------



GRA-021 GWR-070

1970-81 Door Glass Roller Assembly

Front is galvanized as original with gaskets and retaining nut. Rear is plated as original with gaskets and retaining nut.

GRA-021	1970-81 Front.....	36.99 ea.
GWR-070	1970-81 Rear.....	19.99 ea.



Window Rollers

Correct replacement window rollers.

WR-76	1967-69 Lower Rear 1/4	8.95 ea.
WR-78	1967-69 Door	12.95 ea.
WR-342	1970-72 Door	9.95 ea.
WR-907	1967-68 1/4 Stud/Spring	14.99 ea.



1967-69 Quarter Window Track Stud

The correct hardware to mount the quarter tracks to the body.

GWN-251	Studs 3pc	16.99 set
GWN-185	Nuts 3pc.....	7.99 set

Does one window.



Quarter Window Roller Tension Spring

GTS-177	1967-69 All	5.95 ea.
---------	-------------------	----------



RSC-072

1967-69 Glass Inner Sash Channel

Zinc plated inner door sash channel featuring integral blind nuts to replace the commonly damaged or missing original exactly.

RSC-748D	1967 All LH & RH	21.99 ea.
RSC-072	1968-69 All LH & RH.....	16.99 ea.



RSC-603

Front Door Window Upper Sash Channel

OE style reproduction of this commonly missing piece which the window regulator rollers ride in to raise and lower the door window.

RSC-748C	1967 All LH & RH	23.99 ea.
RSC-603	1968-69* All LH & RH.....	15.99 ea.

Use GSA-057 to mount to door glass.

IFW-2



Door Panel Washers

Foam washers used under the door panels to seal door handles and window cranks.

IFW-2	1967-81 All	6.95 pr.
-------	-------------------	----------



IPX-67GMKIT-BLK

1967-72 Factory Correct Window Cranks

Quality die cast. Correct spline depth and clip engagement. Shorter and with a flatter curvature than later years, with correct thin knob. All 1968 and 1969 front features cast number 9715291. 1969 rear and all 1970-72 features cast number 9717838. Clips are included.

IPX-67GMKIT-BLK	1967 Black Knob 4pc	47.81 ea.
IPX-67GMKIT-CLR	1967 Clear Knob 4pc.....	47.81 ea.
IPX-68GMKIT-BLK	1968 Black Knob 4pc.....	56.82 ea.
IPX-68GMKIT-CLR	1968 Clear Knob 4pc.....	50.82 ea.
IPX-69GMKIT-BLK	1969 Black Knob 4pc.....	53.82 ea.
IPX-69GMKIT-CLR	1969 Clear Knob 4pc.....	53.82 ea.
IPQ-67GMB	1967 Black Knob	12.99 ea.
IPQ-67GMC	1967 Clear Knob	12.99 ea.
IPQ-68GMB	1968-69 Front, 68 Rear Black Knob.....	16.99 ea.
IPQ-68GMC	1968-69 Front, 68 Rear Clear Knob.....	14.99 ea.
IPQ-69RGM	1970-72 Front, 69 Rear Black Knob.....	14.99 ea.
IPQ-69RGM	1970-72 Front, 69 Rear Clear Knob.....	14.99 ea.



IPX-4078B



IPX-4078C

Window Cranks & Hardware

OE style reproduction window cranks in kits or individually! Include 4 cranks, 4 clips and 4 gaskets.

IPX-4078C	1967-81 Clear Knob	26.70 kit
IPX-4078B	1967-81 Black Knob	26.70 kit
IPQ-4080C	1967-81 Clear Knob	6.95 ea.
IPQ-4080B	1967-81 Black Knob	6.95 ea.
IPQ-82F	1982-92 All Black	5.99 ea.
IPX-3850	All Gasket	1.95 ea.
IPX-39	All Spring.....	1.95 ea.
IPX-38	All Clip.....	0.75 ea.

No Volume Discount on kits.

REG-67FL



REG-68FXL

REG-71FR

REG-67FRL

Window Regulators

OE style reproduction window regulators complete and ready to install. Available for standard and deluxe interiors.

Door Windows

REG-67FL	1967 Standard LH	69.95 ea.
REG-67FR	1967 Standard RH	69.95 ea.
REG-67FXL	1967 Deluxe LH	69.95 ea.
REG-67FXR	1967 Deluxe RH.....	69.95 ea.
REG-68FL	1968-69 Standard LH	69.95 ea.
REG-68FR	1968-69 Standard RH.....	69.95 ea.
REG-68FXL	1968-69 Deluxe LH.....	69.95 ea.
REG-68FXR	1968-69 Deluxe RH	69.95 ea.
REG-71FL	1970-81 All LH	69.95 ea.
REG-71FR	1970-81 All RH	69.95 ea.

Quarter Windows

REG-67FRL	1967-69 All LH*	69.95 ea.
REG-67FRR	1967-69 All RH*	69.95 ea.

*Must Use 1967 Window Cranks



RWT-67RL

RWT-67RR

RWT-68LR

RWT-68RF

RWT-679L

RWT-679R

Window Tracks

Finally available! Constructed of heavy gauge stamped steel window track with correct plating.

RWT-67FL	1967 LH Door Front All	134.99 ea.
RWT-67FR	1967 RH Door Front All.....	134.99 ea.
RWT-67RL	1967 LH Door Rear All	64.99 ea.
RWT-67RR	1967 RH Door Rear All	64.99 ea.
RWT-68LF	1968-69 LH Door Front All	59.99 ea.
RWT-68RF	1968-69 RH Door Front All	59.99 ea.
RWT-68LR	1968-69 LH Door Rear All.....	59.99 ea.
RWT-68RR	1968-69 RH Door Rear All.....	59.99 ea.
RWT-679L	1967-69 LH Rear 1/4 Window All ...	49.99 ea.
RWT-679R	1967-69 RH Rear 1/4 Window All ..	49.99 ea.
RWT-679K	1967-69 Rear 1/4 Window All.....	89.95 kit

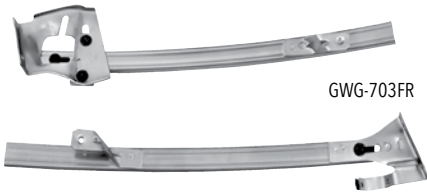

GWG-703FR

Window Rear Guides

Correct 2 pc. guides for rear of door windows.

GWG-703FL	1970-73 LH.....	74.95 pr.
GWG-703FR	1970-73 RH.....	74.95 pr.



4432790

GWS-712

Power Window Switch

Correct OEM style power window switch.

4432790	1967-70 1 Window.....	39.95 ea.
4432791	1967-70 4 Window.....	63.95 ea.
GWS-711	1971-81 1 Window.....	39.95 ea.
GWS-712	1971-81 2 Window.....	49.95 ea.



GHB-6481

Power Window Grommets

This is the correct grommet that runs from the A-pillar to the door on cars with power windows and/or locks.

GHB-6481	1967-81.....	8.95 ea.
----------	--------------	----------



TRIM-01

TRIM-02

TRIM-WR

TRIM-MAG

TRIM-KIT

Trim Removal Tools

TRIM-01	All.....	9.97 ea.
TRIM-02	All.....	5.95 ea.
TRIM-WR	Window Roller Removal Tool.....	14.95 ea.
TRIM-KIT	Trim Removal Kit 5pc.....	24.95 set
TRIM-MAG	Mirror & Magnet Kit 2pc.....	14.95 set



PWK-67CAM-CRANK



PWK-67CAM-2-BLACK



PWK-68CAM



Power Window Retrofit Kits

Ground Ups exclusive power window kits are the best available on the market today! They bolt into the original mounting holes making for a hassle free installation. Using 1018 cold-roll steel, bronze oilite thrust bearings at all the pivot points and heat treated metal for all gears results in a quality smooth operating regulator that will last for many years. The motors are all brand new and have been thoroughly tested for quality and feature a strong dependable motor. Kits include: new regulators, new ACI window motors, a new completed wiring harness, your choice of switches and the conduit from the a-pillar to the door. Our kits feature detailed instructions with helpful diagrams and photos. (F/R = Front and Rear Kit)

PWK-67CAM	1967 All F/R, Chrome Switches.....	924.99 kit
PWK-67CAM-NOST	1967 All F/R, Nostalgic Switches.....	1069.99 kit
PWK-67CAM-CRANK	1967 All F/R, Crank Switches.....	1199.99 kit
PWK-67CAM-2-CHROME	1967 All Front Only, Chrome Switches.....	473.99 kit
PWK-67CAM-2-BLACK	1967 All Front Only, Black Switches.....	473.99 kit
PWK-67CAM-2-NOST	1967 All Front Only, Nostalgic Switches.....	559.99 kit
PWK-67CAM-2-CRANK	1967 All Front Only, Crank Switches.....	618.99 kit
PWK-68CAM	1968-69 All F/R, Chrome Switches.....	924.99 kit
PWK-68CAM-NOST	1968-69 All F/R, Nostalgic Switches.....	1069.99 kit
PWK-68CAM-CRANK	1968-69 All F/R, Crank Switches.....	1199.99 kit
PWK-68CAM-2-CHROME	1968-69 All Front Only, Chrome Switches.....	473.99 kit
PWK-68CAM-2-BLACK	1968-69 All Front Only, Black Switches.....	473.99 kit
PWK-68CAM-2-NOST	1968-69 All Front Only, Nostalgic Switches.....	559.99 kit
PWK-68CAM-2-CRANK	1968-69 All Front Only, Crank Switches.....	548.99 kit

Door Mounted Switches

PWK-70CAM-CHROME	1970-81 All Front, Chrome Switches.....	473.99 kit
PWK-70CAM-BLACK	1970-81 All Front, Black Switches.....	473.99 kit
PWK-70CAM-NOST	1970-81 All Front, Nostalgic Switches.....	559.99 kit
PWK-70CAM-CRANK	1970-81 All Front, Crank Switches.....	618.99 kit

Console Mounted Switches

PWK-73CAM-CHROME	1973-81 All Front, Chrome Switches.....	463.99 kit
PWK-73CAM-BLACK	1973-81 All Front, Black Switches.....	463.99 kit
PWK-73CAM-NOST	1973-81 All Front, Nostalgic Switches.....	548.99 kit

No volume discount. Not eligible for free shipping.





BUY 'N SAVE
WITH KITS

Junior Weatherstrip Kits

Our most popular weatherstrip kit includes all of the basic soft trim components that commonly crack and wear out on your Camaro. Included are (2) door opening weatherstrips, (2) roofrail weatherstrips (coupe only) and (1) trunk weatherstrip.

JR-67F	1967 Coupe	107.82 kit
JR-67FV	1967 Convertible	60.27 kit
JR-68F	1968-69 Coupe	107.82 kit
JR-68FV	1968-69 Convertible	60.27 kit
JR-70F	1970-81 All	117.48 kit
JR-70FT	1978-81 w/ Fisher T-Tops	208.68 kit

1967-69 Deluxe Weatherstrip Kits

This NEW and IMPROVED kit now includes OEM factory style window felts. This kit is great when you want to replace all of the major weatherstripping on your car. Included are (2) door weatherstrips, (2) roof rail weatherstrips (coupe only), (1) trunk weatherstrip, (1) OEM style windowfelt set, (2) door "U" rubbers and (2) quarter glass seals.

JDX-67FK8	1967 Coupe 8pc Felts	227.61 kit
JDX-67FKV8	1967 Convertible 8pc Felts	200.46 kit
JDX-68FK4	1968-69 Coupe Std Interior 4pc Felts	231.86 kit
JDX-68FK8	1968-69 Coupe Std Interior 8pc Felts	261.61 kit
JDX-68FK8D	1968-69 Coupe Dlx Interior 8pc Felts	241.21 kit
JDX-68FKV4	1968-69 Conv Std Interior 4pc Felts	170.71 kit
JDX-68FKV8	1968-69 Conv Std Interior 8pc Felts	200.46 kit
JDX-68FKV8D	1968-69 Conv Dlx Interior 8pc Felts	200.46 kit
JDX-68FK8S	1968 Coupe Std Int w/ Door Ledge Mld 8pc Felts	248.01 kit
JDX-68FKV8S	1968 Conv Std Int w/ Door Ledge Mld 8pc Felts	200.46 kit
JDX-68FK8DS	1968 Coupe Dlx Int w/ Door Ledge Mld 8pc Felts	229.31 kit
JDX-68FKV8DS	1968 Conv Dlx Int w/ Door Ledge Mld 8pc Felts	181.76 kit

1970-81 Deluxe Weatherstrip Kits

Complete weatherstrip kit including (2) door weatherstrips, (2) roof rail weatherstrips, (1) trunk weatherstrip and original style window felts.

JDX-81	1970-81 2pc Felts w/ Chrome Bead*	160.67 kit
JDX-814	1970-81 4pc Felts w/ Chrome Bead*	203.07 kit
JDX-81C	1970-81 2pc Felts w/o Chrome Bead	140.67 kit
JDX-81C4	1970-81 4pc Felts w/o Chrome Bead	205.47 kit

*not for use with special chrome exterior door molding. Ships Oversize.

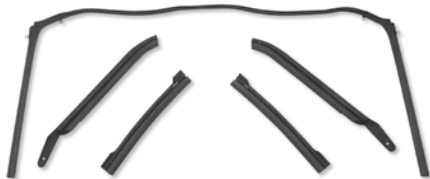

Convertible Top Weatherstrip Kits JSS-3043

New state of the art Metro convertible top weatherstrip kit featuring steel frames with molded rubber, correct seams and extension flaps. Header seal has correct pins and molded corners. Made in USA.

JSS-3043	1967 Convertible	189.95 kit
JSS-3043-OE	1968-69 Convertible	189.95 set
JSS-RR1510	1987-92 Sides Only 4pc	199.95 kit
JSS-RR1515	1987-92 Side, Header, Bow 6pc	449.95 kit
JSS-HD1520	1987-92 Tonneau Panel Seal	49.95 ea.

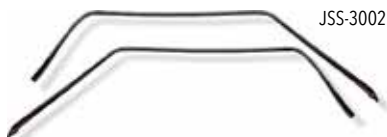

Roof Rail Weatherstrip

Correct extruded rubber that seals the roof line of the car in from the elements.

JSS-3002	1967 Coupe	55.95 pr.
JSS-3013	1968-69 Coupe	55.95 pr.
JSS-3100	1970-81 All	65.95 pr.
JSS-RR7003	1982-92 Coupe	74.95 pr.
BRR-220	1967-69 Screws 24pc	19.99 kit
BRR-221	1970-81 Screws 36pc	29.99 kit



RRC-69

Roof Weatherstrip Channel

High luster stainless steel like original. Bolts onto the roof channel to retain the roof rail weatherstrip.

RRC-67F	1967 Coupe 6pc	199.95 kit
RRC-69	1968-69 Coupe 6pc	199.95 kit

This item ships Oversize. No volume discount.

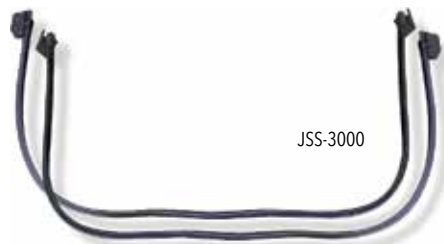

JSS-3000

Door Opening Weatherstrip

This brand new state of the art door weatherstrip features correct extruded rubber with correct molded ends and push in clips just like original.

JSS-3000	1967 All	55.95 pr.
JSS-3010	1968-69 All	55.95 pr.
JSS-3015	1970-81 All	65.95 pr.
JSS-22-C	1982-92 All	59.95 pr.



Trunk Weatherstrip

Correct molded trunk weatherstrip.

JSS-203	1967-69 All	14.95 ea.
JSS-209	1970-81 All	12.95 ea.
JSS-46F	1982-92 Coupe	29.95 pr.
JSS-46FC	1982-92 Convertible	29.95 pr.



JSS-302U

Door Jamb U Rubbers

Correct steel core rubber.

JSS-302U	1967-69 All	16.99 pr.
----------	-------------------	-----------



Vent Window Seals JSS-3125
Correct vent window weatherstrip.
JSS-3125 1967 All 59.95 pr.



Vent Channel Run JSS-7011
Correct rubber flocked weatherstrip that runs vertically in the vent frame.
JSS-7011 1967 All 24.95 pr.



Convertible Header Seal JSS-3044
This seal features correct molded ends.
JSS-3044 1967 Convertible 82.95 ea.
JSS-3044-OE 1968-69 Convertible 89.95 ea.
JSS-HD1510 1987-92 144.95 ea.

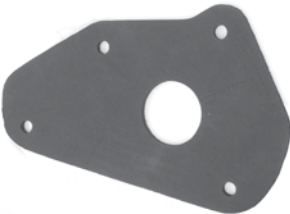

Steering Column Seal JSS-79
Correct neoprene seal for firewall.
JSS-79 1967-68 All 5.99 ea.
JSS-69 1969 All 5.99 ea.
JSS-89 1970-81 All 11.99 ea.



Steering Column Boot JCB-3
Correct rubber boot that mounts between the steering column and firewall.
JCB-3 1967-69 All 13.99 ea.



A-Arm Dust Shields CA109
Correct die stamped material that seals the engine compartment. Mounts to inner fender wells, complete with staples.

CA109	1967-68 Complete 5pc.....	21.99 kit
CA110	1969 Complete 5pc.....	21.99 kit
JHC-105	1967-68 A-Arms Only	13.99 pr.
JHC-106	1969 A-Arms Only.....	11.99 pr.
JHC-110	1970-81 A-Arms Only	11.99 pr.
JHC-108	1967-69 Fender/Cowl	5.99 ea.
JHC-107	1967-69 Frame	8.99 pr.



Cowl-Firewall Seal Kit JBH-69
Correct die-stamped gasket kit containing steering column seal, hood to cowl seal, cowl vent side seals and wiper motor seal. 5 pieces.
JBH-67 1967 All 23.99 kit
JBH-68 1968 All 23.99 kit
JBH-69 1969 All 23.99 kit



Hood to Cowl Seal JSS-3023
Correct rubber seal that mounts to the top edge of the cowl to seal the engine compartment. Each seal is cut to the correct length and is ready to install.
JSS-3023 1967-69 All 9.95 ea.
JSS-231 1970-81 All 21.99 ea.
JCS-686 1970-81 Clips 18pc..... 13.99 kit
JSS-CS15A 1982-92 All 21.95 ea.



Steering Shaft Boot & Retainer DSB-83
Correct boot and seal.
DSB-83 1967-69 Boot..... 32.95 ea.
DBR-647 1967-79 Retainer..... 5.95 ea.



Quarter Glass Seals JSS-3022
Correct rubber seal which attaches to the quarter window and seals the front and rear windows. Features steel core with rubber coating as factory.
JSS-302R 1967-69 Replacement Style 13.95 ea.
JSS-3022 1967-69 OE style w/ Steel Core..... 18.95 pr.



Pillar Post Weatherstrip JSS-67
Correct heavy duty molded rubber that runs vertically on the pillar posts.
JSS-67 1967 Convertible 55.95 pr.
JSS-68P 1968-69 Convertible..... 55.95 pr.
JSS-F 1967-69 Fasteners..... 2.50 kit



T-Top Weatherstrip JSS-3388
High quality weatherstrips which will eliminate the rattles and leaks from your factory T-Tops.

T-Top Weatherstrip
High quality weatherstrips which will eliminate the rattles and leaks from your factory T-Tops.
JSS-78FS 1978-81 Side Rail Seals Fisher 64.95 pr.
JSS-3388 1978-81 Main Body Seals Fisher..... 179.95 pr.
JSS-ELP7003 1987-92 Side Rail Seals..... 39.95 pr.
JSS-7003 1987-92 Main Body Seals..... 165.95 pr.
JSS-ALP11C 1987-92 Door Window Seal..... 29.95 ea.



Weatherstrip Glue JSS-3M
5 ounce tube of 3M weatherstrip glue.
JSS-3M All Yellow..... 8.95 ea.
JSS-3M-BLK All Black..... 10.95 ea.

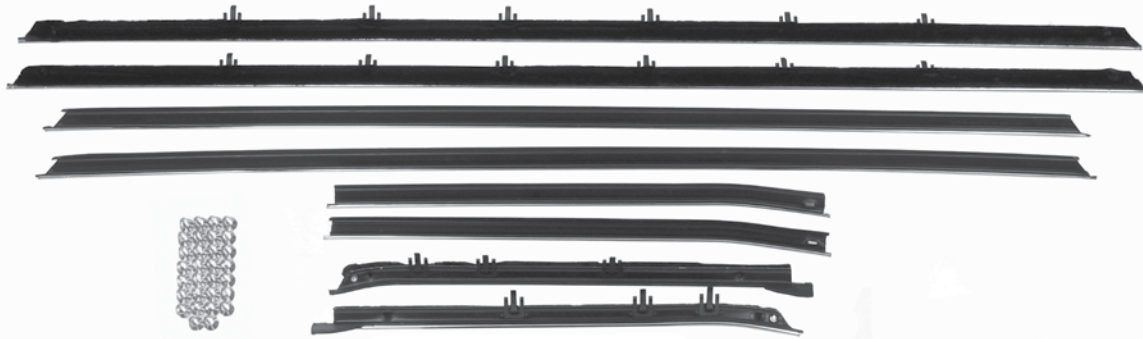

CA166A

Complete Window Felt Kits

These OE style reproduction window felts feature correct stainless round beads with flocked rubber sealing strips. All include the correct anti-rattle bumpers attached.

1967-69 8 Piece Inner & Outer Original Style Kits

CA168A	1967 Coupe.....	109.99 kit
CA169A	1967 Convertible	133.99 kit
CA146A	1968 Coupe Std w/ Special Molding*.....	133.99 kit
CA147A	1968 Convertible Std w/ Special Molding*.....	133.99 kit
CA160	1968 Coupe Dlx w/ Special Molding.....	111.99 kit
CA161FSM	1968 Convrt Dlx w/ Special Molding	111.99 kit
CA166A	1968-69 Coupe Standard.....	149.99 kit
CA173A	1968-69 Convertible Standard.....	133.99 kit
CA172A	1968-69 Coupe Deluxe.....	125.99 kit
CA162A	1968-69 Convertible Deluxe.....	133.99 kit

**For use with special chrome exterior door ledge moldings.*

1967-69 Replacement Style Window Felts Kits

CA142R	1967 Coupe	95.99 kit
CA143R	1967 Convertible	98.99 kit
CA144R	1968-69 Coupe	98.99 kit
CA145R	1968-69 Coupe	88.99 kit

1970-81 4 Piece Inner & Outer Original Style Kits

CA164A	1970-81 w/ Chrome Bead*	106.99 kit
CA165A	1970-81 w/o Chrome Bead	109.99 kit

**Not for use with special exterior chrome door molding.*



Top: 1970-81 with Chrome Bead
Bottom: 1970-81 without Chrome Bead

Outer Window Felt Kits

These OE style reproduction window felts feature correct stainless round beads with flocked rubber sealing strips. All include the correct anti-rattle bumpers attached.

1967-69 4 Piece Outer Original Style Kits

CA154A	1967 Coupe.....	88.99 kit
CA155A	1967 Convertible	79.99 kit
CA156A	1968-69 Coupe.....	114.99 kit
CA157A	1968-69 Convertible.....	98.99 kit
CA158A	1968 Coupe w/ Door Ledge Molding	77.99 kit
CA159A	1968 Convrt w/ Door Ledge Molding	69.99 kit

1970-81 2 Piece Outer Original Style Kits

CA170A	1970-81 w/ Chrome Bead*	53.99 kit
CA171A	1970-81 w/o Chrome Bead	28.99 kit

**Not for use with special exterior chrome door molding.*

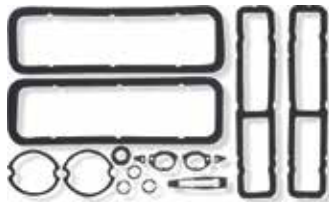

JHC-1127

Paint Seal Kit

This kit is a must for all of those partial or full restorations!

JHC-1127	1967 Standard.....	21.99 kit
JHC-128	1968 Standard	23.99 kit
JHC-1131	1969 All	23.99 kit
JHC-12RS	1967-68 RS Supplement.....	8.99 kit



JSS-089

Convertible Rear Frame to Body Seals

Seals prevent water drainage into rear of body and trunk area. Molded rubber with stamped steel spine as original.

JSS-089	1967-69.....	39.99 pr.
---------	--------------	-----------



JHC-3064

Heater Box Seal Kits

Correct die stamped neoprene seals for installing your heater core and cover. A must!

JHC-3064	1967-81 All V8 w/o A/C.....	22.99 kit
----------	-----------------------------	-----------

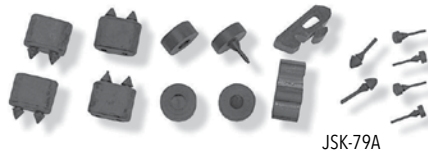

JSK-79A

Rubber Stopper Kits

Complete set of rubber stoppers including doors, hood, console, glove box and trunk lid.

JSK-79A	1967-69 All.....	11.95 kit
JSK-81K	1970-81 All.....	16.95 kit



MG-35

1970-73 Rear Bumper Gaskets

Molded rubber bumper end fillers.

MG-35	1970-73.....	29.95 pr.
-------	--------------	-----------



MBB-555

1970-73 Bumper Bracket Cushions

MBB-555	1970-72 All, 1973 RS.....	14.99 pr.
---------	---------------------------	-----------



15065

Wiring Harnesses

When you are looking to restore your electrical system, look no further than Ground Up! All of our harnesses are hand assembled in the USA and are guaranteed exactly as original. Our harnesses always match the factory color code and gauge sizes using correct connectors, terminals and non-adhesive cloth tape. Our restoration harnesses are simply the best in the industry.

A/T = Automatic Transmission M/T = Manual Transmission
AC = Air Conditioning Ctr Fuel = Center Fuel Gauge

A/C Harness

10750	1967 w/o Low Blower.....	122.99 ea.
29925	1967 w/o Low Blower Early.....	117.99 ea.
12095	1968 Includes Heater Wire.....	117.99 ea.
13015	1969 Includes Heater Wire.....	119.99 ea.
15200	1970 Includes Heater Wire.....	118.99 ea.
15435	1971 Includes Heater Wire.....	123.99 ea.
16395	1972 Includes Heater Wire.....	129.99 ea.
37799	1973 w/ 4 Contact.....	124.99 ea.
37801	1973 w/ 5 Contact.....	124.99 ea.
00990	1973 Extension.....	27.99 ea.
37800	1974 Compressor to AC.....	123.99 ea.
00990	1974 Extension.....	27.99 ea.
16610	1975 w/ Ambient Sensor.....	124.99 ea.
17140	1975 w/ Pressure Cutoff.....	123.99 ea.
00990	1975 Extension Before 6/6/75.....	27.99 ea.
37992	1975 Ext 6 Cyl After 6/6/75.....	14.99 ea.
37993	1975 Ext V8 After 6/6/75.....	14.99 ea.
17140	1976 Includes Heater Wire.....	123.99 ea.
37992	1976 Extension 6 Cyl.....	14.99 ea.
37993	1976 Extension V8.....	14.99 ea.
37992	1977 Extension 6 Cyl.....	14.99 ea.
37994	1977 Extension V8.....	44.99 ea.
37992	1978 Extension 6 Cyl.....	14.99 ea.
37994	1978 Extension V8.....	44.99 ea.
37991	1979 Includes Heater Wire.....	138.99 ea.
37992	1979 Extension 6 Cyl.....	14.99 ea.
37994	1979 Extension V8.....	44.99 ea.

A/C Power Feed Wire

Connects horn relay to A/C fuse.

10970	1967-71 All.....	16.99 ea.
16405	1972 All.....	17.99 ea.

A/C Compressor Ground Wire

12975	1969-76.....	12.99 ea.
37995	1977-79.....	8.99 ea.

Air Induction

36268	1980 Kickdown Harness.....	40.99 ea.
36270	1980 Solenoid Extension.....	17.99 ea.

Clock Harness

10855	1967 Console Clock.....	31.99 ea.
11960	1968-69 Console Clock.....	30.99 ea.
12965	1969 Center Dash Clock.....	30.99 ea.
17500	1970-79 Dash Clock.....	20.99 ea.
36267	1980 Clock & Glove Box.....	32.99 ea.

Console Gauge Harness

Connects gauges to console harness.

32640	1967 A/T Column Shift.....	106.99 ea.
32635	1967 A/T Console Shift.....	106.99 ea.
32630	1967 M/T All.....	106.99 ea.
32655	1968 A/T Column Shift.....	106.99 ea.
32650	1968 A/T Console Shift.....	106.99 ea.
32645	1968 M/T All.....	106.99 ea.
32670	1969 A/T Column Shift.....	106.99 ea.
32665	1969 A/T Console Shift.....	106.99 ea.
32660	1969 M/T All.....	106.99 ea.

A/T = Automatic Transmission M/T = Manual Transmission

Console Harness

10790	1967 A/T.....	45.99 ea.
10795	1967 A/T w/ Gauges.....	73.99 ea.
10800	1967 M/T.....	19.99 ea.
10805	1967 M/T w/ Gauges.....	55.99 ea.
11945	1968 A/T.....	44.99 ea.
11950	1968 A/T w/ Gauges.....	69.99 ea.
11940	1968 M/T.....	19.99 ea.
11955	1968 M/T w/ Gauges.....	55.99 ea.
17510	1969 A/T.....	44.99 ea.
13085	1969 A/T w/ Gauges.....	69.99 ea.
17505	1969 M/T.....	19.99 ea.
13090	1969 M/T w/ Gauges.....	55.99 ea.
17515	1970 A/T.....	34.99 ea.
17505	1970 M/T.....	19.99 ea.
17515	1971 A/T.....	34.99 ea.
17505	1971 M/T.....	19.99 ea.
17515	1972 Early Prod. A/T w/ Neutral Safety Switch in Console.....	34.99 ea.
17505	1972 All M/T, Late Prod A/T w/ Neutral Safety Switch on Column.....	19.99 ea.
15650	1979-80 Auto Shift Indicator.....	19.99 ea.

A/T = Automatic Transmission M/T = Manual Transmission

Courtesy Lamp Harness

13875	1967 Deluxe Side Panels.....	32.99 ea.
13870	1967-69 Roof Dome.....	21.99 ea.
17525	1967 Under Dash, Convert.....	32.99 ea.
08300	1967-68 Under Dash, Coupe.....	32.99 ea.
33820	1968 Under Dash, Convert.....	32.99 ea.
14295	1969 Under Dash, All.....	32.99 ea.
17575	1970-73 Roof Dome.....	32.99 ea.
15170	1970-73 Under Dash.....	32.99 ea.
40042	1974 Roof Dome.....	32.99 ea.
40130	1975-77 Roof Dome.....	32.99 ea.
36230	1974-79 Under Dash.....	33.99 ea.

Courtesy Lamp Switch Jumper Harness

Door jamb switch to dash harness.

36038	1973-80 LH.....	11.99 ea.
36039	1973-80 RH.....	8.99 ea.

Cowl Induction Harness

AHQ-1143	1969.....	42.99 ea.
----------	-----------	-----------

Also works on 67-68 with 69 cowl induction setup.

Cruise Control Harness

10775	1967.....	61.99 ea.
11885	1968.....	56.99 ea.
13185	1969-70.....	58.99 ea.



HWD-67F

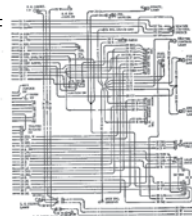

Dash Harness

10220	1967 A/T Column Shift.....	435.99 ea.
10780	1967 M/T Column Shift.....	435.99 ea.
10785	1967 A/T Console Shift.....	435.99 ea.
17535	1967 A/T Console, Gauges.....	435.99 ea.
10990	1967 M/T Console Shift.....	435.99 ea.
10995	1967 M/T Console, Gauges.....	435.99 ea.
18005	1968 A/T Column Shift.....	462.99 ea.
11840	1968 M/T Column Shift.....	462.99 ea.
11850	1968 A/T Console Shift.....	462.99 ea.
11860	1968 A/T Console, Gauges.....	462.99 ea.
11845	1968 M/T Console Shift.....	462.99 ea.
11855	1968 M/T Console, Gauges.....	462.99 ea.
12065	1968 A/T Floor Shift.....	462.99 ea.
13025	1969 All Column Shift.....	462.99 ea.
13115	1969 All Column Shift w/ A/C.....	462.99 ea.
13205	1969 Column, Tach, Ctr Fuel.....	462.99 ea.
13035	1969 A/T Console Shift.....	462.99 ea.
13125	1969 A/T Console, AC.....	462.99 ea.
13225	1969 A/T Con, Gauges, Tach.....	462.99 ea.
13215	1969 A/T Con, Tach/Ctr Fuel.....	462.99 ea.
13030	1969 M/T Console Shift.....	462.99 ea.
13120	1969 M/T Console Shift, A/C.....	462.99 ea.
13220	1969 M/T Con Gauges, Tach.....	462.99 ea.
13210	1969 M/T Con, Tach/Ctr Fuel.....	462.99 ea.
35915	1970 A/T Column Shift.....	399.99 ea.
35916	1970 A/T Column Shift w/ A/C.....	399.99 ea.
35917	1970 A/T Console Shift.....	391.99 ea.
35918	1970 M/T Console Shift.....	391.99 ea.
35919	1970 M/T Floor Shift.....	399.99 ea.
35920	1970 M/T Floor Shift w/ A/C.....	401.99 ea.
35921	1971 All.....	391.99 ea.
35922	1972 All.....	417.99 ea.

All, except early production console shift auto trans with neutral safety switch mounted in console.

35923 1972 A/T Console Shift..... 407.99 ea.
Early production, console shift, auto trans with neutral safety switch mounted in console.

16555	1973 w/ Warning Lights.....	516.99 ea.
16560	1973 w/ Gauges.....	498.99 ea.
18700	1974 w/ Warning Lights.....	583.99 ea.
18705	1974 w/ Gauges.....	562.99 ea.
18710	1975 w/ Warning Lights.....	616.99 ea.

with seatbelt interlock ignition relay

36020	1975 w/ Warning Lights.....	589.99 ea.
-------	-----------------------------	------------

without seatbelt interlock ignition relay

36015	1975 w/ Gauges.....	616.99 ea.
-------	---------------------	------------

with seatbelt interlock ignition relay

36019	1975 w/ Gauges.....	589.99 ea.
-------	---------------------	------------

without seatbelt interlock ignition relay

38079	1976 w/ Warning Lights.....	589.99 ea.
38080	1976 w/ Gauges.....	589.99 ea.

36018	1977 w/ Warning Lights.....	589.99 ea.
36017	1977 w/ Gauges.....	589.99 ea.

37999	1978 w/ Warning Lights.....	600.99 ea.
37998	1978 w/ Gauges.....	589.99 ea.

38001	1979 A/T w/ Warning Lights.....	610.99 ea.
38000	1979 A/T w/ Gauges.....	600.99 ea.

38003	1979 M/T w/ Warning Lights.....	610.99 ea.
38002	1979 M/T w/ Gauges.....	610.99 ea.

Wiring Diagrams

Original GM wiring schematic from bumper to bumper.

HWD-67F	1967.....	9.99 ea.
HWD-68F	1968.....	9.99 ea.
HWD-69F	1969.....	9.99 ea.
HWD-RS	1967-69 RS.....	9.99 ea.
HWD-70F	1970.....	9.99 ea.
HWD-71F	1971.....	9.99 ea.
HWD-72F	1972.....	9.99 ea.
HWD-73F	1973.....	9.99 ea.



39386



39386
Detail

Dash Harness Classic Auto Fuse Series

Our new Classic Auto Fuse Series dash harnesses allow you to maintain the easy plug and play function of original factory type harnesses, while converting the entire fuse block to an Auto Fuse Series (ATO Type) fuse block. This gives you the flexibility to add additional power circuits without the installation headaches normally associated with this type of fuse box conversion. There is no cutting or modifying of any sort. Just plug it in and turn it on. It is completely compatible with the other original harnesses in your car.

39386	1968 A/T Column Shift.....	534.99 ea.
39387	1968 M/T Column Shift.....	534.99 ea.
39388	1968 A/T Console Shift.....	534.99 ea.
39389	1968 A/T Console Shift w/ Gauges.....	499.95 ea.
39390	1968 M/T Console Shift.....	534.99 ea.
39391	1968 M/T Console Shift w/ Gauges.....	534.99 ea.
39392	1968 A/T Floor Shift w/o Console.....	534.99 ea.
39393	1969 A/T or M/T Column Shift.....	534.99 ea.
39394	1969 A/T or M/T Column Shift w/ A/C.....	534.99 ea.
39395	1969 Column Shift, A/T or M/T, Tach & Center Fuel Gauge.....	534.99 ea.
39396	1969 A/T Console Shift.....	534.99 ea.
39397	1969 A/T Console Shift w/ A/C.....	534.99 ea.
39398	1969 A/T Console Shift w/ Gauges & Tach.....	534.99 ea.
39399	1969 A/T Console Shift, w/ Tach, Ctr Fuel, & Warning Lights.....	499.95 ea.
39400	1969 M/T Console Shift.....	534.99 ea.
39401	1969 M/T Console Shift w/ A/C.....	534.99 ea.
39402	1969 M/T Console Shift w/ Gauges & Tach.....	534.99 ea.
39403	1969 M/T Console Shift, w/ Tach, Ctr Fuel, & Warning Lights.....	534.99 ea.

No Volume Discount

Dash Cluster Harness

14975	1970 w/ Warning Lights.....	102.99 ea.
14985	1970 w/ Gauges.....	102.99 ea.
15365	1971 w/ Warning Lights.....	102.99 ea.
15370	1971 w/ Gauges.....	102.99 ea.
34920	1972 w/ Warning Lights.....	120.99 ea.
33870	1972 w/ Warning Lights, Belt.....	120.99 ea.
<i>with seat belt warning light</i>		
16325	1972 w/ Gauges.....	128.99 ea.
16525	1972 w/ Gauges, Seat Belt.....	128.99 ea.

with seat belt warning light

Engine Harness

11260	1967 6 Cylinder.....	91.99 ea.
11290	1967 V8 w/o Gauges.....	91.99 ea.
11295	1967 V8 w/ Gauges.....	91.99 ea.
11300	1967 396 w/o Gauges.....	91.99 ea.
11305	1967 396 w/ Gauges.....	91.99 ea.
11815	1968 6 Cylinder.....	94.99 ea.
11820	1968 V8 w/o Gauges.....	94.99 ea.
12080	1968 396 w/o Gauges.....	91.99 ea.
12025	1968 All V8 w/ Gauges.....	91.99 ea.
11815	1969 6 Cylinder.....	94.99 ea.
12970	1969 V8 w/o Gauges.....	91.99 ea.
13170	1969 V8 w/ Gauges.....	94.99 ea.
12080	1969 396 w/o Gauges.....	91.99 ea.
13175	1969 396 w/ Idle Stop.....	94.99 ea.
17545	1969 All V8 w/ Gauges.....	91.99 ea.
13180	1969 All V8 w/ Gauges & Idle.....	91.99 ea.
14945	1970 A/T 6 Cylinder.....	152.99 ea.
14935	1970 M/T 6 Cylinder.....	152.99 ea.
14955	1970 A/T SB, non-TH400.....	144.99 ea.
15255	1970 A/T SB, TH400.....	152.99 ea.
14940	1970 M/T SB.....	144.99 ea.
14960	1970 A/T Big Block.....	152.99 ea.
14950	1970 M/T Big Block.....	146.99 ea.
15390	1971 A/T 6 Cylinder.....	152.99 ea.
15380	1971 M/T 6 Cylinder.....	152.99 ea.
15485	1971 A/T SB non-TH400.....	146.99 ea.
15385	1971 M/T SB.....	146.99 ea.
15450	1971 A/T SB TH400.....	152.99 ea.
15445	1971 A/T BB.....	152.99 ea.
15395	1971 M/T BB.....	146.99 ea.
16330	1972 6 Cylinder.....	186.99 ea.
16335	1972 SB w/o Gauges.....	163.99 ea.
16350	1972 SB w/ Gauges.....	163.99 ea.

*manual requires the use of 17355 TCS extension

16355	1972 SB TH400 w/ Gauges.....	163.99 ea.
16345	1972 A/T BB w/o Gauges.....	163.99 ea.
16365	1972 A/T BB w/ Gauges.....	163.99 ea.
16340	1972 M/T BB w/o Gauges.....	163.99 ea.
16360	1972 M/T BB w/ Gauges.....	163.99 ea.
17015	1973 6 Cylinder.....	172.99 ea.
15500	1973 V8.....	172.99 ea.
15505	1973 V8 w/ Gauges.....	172.99 ea.

*manual requires the use of 17365 TCS extension

16655	1973 V8 TH400 w/o Gauges.....	172.99 ea.
16570	1973 V8 TH400 w/ Gauges.....	172.99 ea.
38008	1974 A/T 6 Cyl W Lights.....	222.99 ea.
16595	1974 M/T 6 Cyl W Lights.....	222.99 ea.
22605	1974 A/T V8 non-TH400.....	172.99 ea.
22590	1974 A/T V8 w/ Gauges.....	172.99 ea.
22585	1974 V8 TH400 w/o HEI.....	179.99 ea.
36009	1974 V8 TH400 w/ HEI.....	169.99 ea.
22600	1974 V8 TH400 HEI Gauges.....	169.99 ea.
22610	1974 M/T V8 w/o HEI.....	172.99 ea.
36012	1974 M/T V8 w/ HEI.....	169.99 ea.
22595	1974 M/T V8 w/ Gauges.....	172.99 ea.
36013	1974 M/T V8 Gauges HEI.....	169.99 ea.
18615	1975 6 Cyl w/o Int Cyl Head.....	199.99 ea.
18610	1975 6 Cyl w/ Int Cyl Head.....	199.99 ea.
18680	1975 All V8.....	169.99 ea.
35990	1976 All 6 Cylinder.....	174.99 ea.
18680	1976 All V8.....	169.99 ea.
35989	1977 6 Cyl w/o CA Emissions.....	174.99 ea.
35988	1977 6 Cyl w/ CA Emissions.....	174.99 ea.
36007	1977 All V8.....	172.99 ea.
35981	1978 6 Cyl w/o CA Emissions.....	179.99 ea.
35980	1978 6 Cyl w/ CA Emissions.....	179.99 ea.
36027	1978 V8 w/ CA Emissions.....	179.99 ea.
36007	1978 V8 w/o CA Emissions.....	172.99 ea.
35986	1979 6 Cyl w/o CA Emissions.....	179.99 ea.
35985	1979 6 Cyl w/ CA Emissions.....	179.99 ea.
36007	1979 V8 w/o CA Emissions.....	172.99 ea.
36025	1979 V8 w/ CA Emissions.....	169.99 ea.

Engine Harness Cont'd

38010	1980 229 6 Cylinder.....	177.99 ea.
36029	1980 All V8.....	169.99 ea.

A/T = Automatic Transmission M/T = Manual Transmission
CA Emission = California Emissions

Engine Harness For HEI

Specially modified harnesses for use with your retrofitted HEI ignition for an easy installation.

38926	1967 V8.....	111.99 ea.
38946	1967 V8 w/ Gauges.....	113.99 ea.
38966	1967 396.....	113.99 ea.
39000	1967 396 w/ Gauges.....	113.99 ea.
38923	1968 V8.....	109.99 ea.
38930	1968 396.....	109.99 ea.
38932	1968 V8 & 396 w/ Gauges.....	109.99 ea.
38925	1969 V8.....	109.99 ea.
39001	1969 V8 w/ Idle Stop.....	111.99 ea.
38930	1969 396.....	109.99 ea.
39016	1969 396 w/ Idle Stop.....	111.99 ea.
38924	1969 V8 & 396 w/ Gauges.....	109.99 ea.
38996	1969 V8 & 396 w/ Gauges & Idle Stop.....	109.99 ea.
38968	1970 V8 Auto Trans.....	159.99 ea.
39052	1970 V8 TH400 Only.....	164.99 ea.
39002	1970 V8 Manual Trans.....	159.99 ea.
39038	1970 396/454 Auto Trans.....	164.99 ea.
39069	1970 396/454 Manual Trans.....	159.99 ea.
38977	1971 V8 Auto Trans.....	159.99 ea.
39017	1971 V8 Manual Trans.....	159.99 ea.
39090	1971 V8 TH400 Only.....	171.99 ea.
39089	1971 396/454 Auto Trans.....	164.99 ea.
39070	1971 396/454 Manual Trans.....	159.99 ea.

Forward Lamp Harness

11425	1967 6 Cyl Rally Sport.....	217.99 ea.
11410	1967 6 Cyl standard.....	164.99 ea.
11430	1967 V8 Rally Sport.....	209.99 ea.
11435	1967 V8 RS w/ Gauges.....	209.99 ea.
11415	1967 V8 standard.....	164.99 ea.
11420	1967 V8 Std w/ Gauges.....	164.99 ea.
11895	1968 6 Cyl Rally Sport.....	169.99 ea.
11825	1968 6 Cyl Standard.....	169.99 ea.
11900	1968 V8 Rally Sport.....	165.99 ea.
11905	1968 V8 RS w/ Gauges.....	165.99 ea.
11830	1968 V8 Standard.....	163.99 ea.
11835	1968 V8 Std w/ Gauges.....	163.99 ea.
12995	1969 All 6 Cyl.....	161.99 ea.
13000	1969 V8 w/o Gauges.....	161.99 ea.
13005	1969 V8 w/ Gauges.....	161.99 ea.
14865	1970 All 6 Cyl.....	174.99 ea.
14870	1970 V8.....	163.99 ea.
15195	1970 V8 w/ AC.....	163.99 ea.
14875	1970 V8 All w/ Gauges.....	163.99 ea.
15320	1971 All 6 Cyl.....	188.99 ea.
15405	1971 V8.....	169.99 ea.
15330	1971 V8 w/ Gauges.....	163.99 ea.
16370	1972 All.....	175.99 ea.
16550	1973 All.....	163.99 ea.
16585	1974 All.....	170.99 ea.
36028	1975 w/o Seatbelt Warning.....	170.99 ea.
18685	1975 w/ Seatbelt Warning.....	179.99 ea.
36026	1976-77 All.....	170.99 ea.
36023	1978 All.....	170.99 ea.
36021	1979-80 All.....	170.99 ea.
36022	1981 All.....	179.99 ea.

Fuel Sender Harness

18915	1967-68 All.....	16.99 ea.
18910	1969 All.....	16.99 ea.
33825	1970-71 All.....	16.99 ea.
33835	1972-73 All.....	17.99 ea.
36272	1974-77 All.....	17.99 ea.
36269	1978-80 All.....	23.99 ea.

Glove Box Lamp Extension

17530	1970-79 w/o AC	16.99 kit
15290	1970-79 w/ AC	18.99 kit

Headlamp Washer Pump Extension Harness

17585	1969 Rally Sport	15.99 ea.
-------	------------------	-----------

Heater Harness

33875	1973-80 w/o AC	32.99 kit
-------	----------------	-----------

Horn Wire

38011	1974-76 Dual Horns	15.99 kit
38012	1977 Dual Horns	15.99 kit
38013	1978-80 Dual Horns	14.99 kit

Kickdown Harness

Connects carburetor switch to transmission.

06085	1967 TH400	32.99 ea.
06145	1968-69 TH400	32.99 ea.

Kickdown Extension

Connect gas pedal switch to engine harness.

17565	1971-74 TH400	23.99 ea.
-------	---------------	-----------

Power Accessory Feed

10755	1967-71 Horn Relay to Power Windows and Top	11.99 ea.
14040	1967-69 Power Window & Power Top Circuit Break to Kick Panel Relay	17.99 ea.

Power Seat Harness

14260	1968 Adjuster Feed	35.99 ea.
14255	1968-69 4 Way	121.99 ea.

Power Top Harness

14035	1967-68	54.95 ea.
14310	1969	54.95 ea.

Power Window Harness

13790	1967 LH w/ Crossover	151.99 ea.
13795	1967 RH	73.99 ea.
14070	1967-69 1/4 Window	54.99 ea.
14207	1968 LH w/ Crossover	158.99 ea.
14290	1968-69 RH	73.99 ea.
14300	1969 LH w/ Crossover	151.99 ea.

Rally Sport Extension

11200	1967 RS Under Dash Diode	40.95 ea.
-------	--------------------------	-----------

Rear Window Defroster Harness

13785	1967	44.99 ea.
14180	1968	44.99 ea.
17555	1969	44.99 ea.
14515	1970-78	47.99 ea.
35984	1979 Dash Side	79.99 ea.

Rear Lamp Harness

14080	1967 RS Convertible	134.99 ea.
14075	1967 Standard Convertible	134.99 ea.
14090*	1967 RS Coupe	134.99 ea.

*with Dash Lamps

14085	1967 Standard Coupe	134.99 ea.
14095*	1967 Standard Coupe	134.99 ea.

*with Dash Lamps

14215	1968 RS Convertible	140.99 ea.
14210	1968 Standard Convertible	140.99 ea.
14205*	1968 RS Coupe	140.99 ea.

*with Dash Lamps

14195	1968 Standard Coupe	140.99 ea.
14200*	1968 Standard Coupe	140.99 ea.

*with Dash Lamps

Rear Lamp Harness Cont'd:

14340	1969 Convrt Dash to 1/4*	73.99 ea.
-------	--------------------------	-----------

*(intermediate)

14330	1969 Coupe Dash to 1/4*	73.99 ea.
-------	-------------------------	-----------

*(intermediate)

14335	1969 Coupe Dash to 1/4	73.99 ea.
14350	1969 RS Rear Panel	114.99 ea.
14345	1969 Standard Rear Panel	114.99 ea.
17170	1970-72 Dash to 1/4*	104.99 ea.

*(intermediate)

14440	1970-73 Rear Panel	115.99 ea.
35924	1973 Dash to 1/4*	118.99 ea.

*(intermediate)

21240	1974-75 Dash to 1/4 Panel*	154.99 ea.
-------	----------------------------	------------

*You must supply your original connectors.

Speaker Harness

18510	1967-68 Single Speaker	33.99 ea.
33425	1967 Front Stereo Speakers	44.99 ea.
08210	1967 Rear Stereo Speakers	32.99 ea.
33430	1967 4 Speaker, Front & Rear	66.99 ea.
18510	1968 Single Rear Speaker	33.99 ea.
33425	1968 Front Stereo Speakers	44.99 ea.
08210	1968 Rear Stereo Speakers	32.99 ea.
33430	1968 4 Speaker, Front & Rear	66.99 ea.
33425	1969 Front Stereo Speakers	44.99 ea.
08210	1969 Rear Stereo Speakers	32.99 ea.
33430	1969 4 Speaker, Front & Rear	66.99 ea.

Speed Warning Harness

Complete assembly for the desirable speed warning module behind the speedometer.

11050	1967	18.99 ea.
11935	1968	18.99 ea.
13130	1969	18.99 ea.

Stereo Tape/Multiplex Harness

35940	1968 Adapter	32.99 ea.
35939	1968-69 Speaker Extension	44.99 ea.

Tach Conversion Harness

When adding a factory dash tach to your 1969 Camaro, this harness allows you to move the fuel gauge to the center position.

33970	1969	25.99 ea.
-------	------	-----------

TCS Transmission Switch Extension

From engine harness to transmission switch.

17355	1972 for 16335/16350/16330	37.99 ea.
17365	1973 for 15500/15505	37.99 ea.

Transistor Ignition Extension Harness

33215	1967-68 TI Extension Harness	16.99 ea.
36053	1969 TI Amplifier Extension	54.99 ea.
23015	1969 TI Coil Ground Wire	8.99 ea.
23060	1969 TI Extension Harness	16.99 ea.
23140	1969 TI Extension Harness w/ Replacement Amp	10.99 ea.
23020	1969 TI Harness	117.99 ea.

Trunk Lamp Harness Assembly

28175	1967-69 Convertible	32.99 ea.
28180	1967-69 Coupe	32.99 ea.
28185	1970-81 All	32.99 ea.

All include extension

Trunk Lamp Extension Harness

28195	1967-69 Convertible	12.99 ea.
28210	1967-69 Coupe	11.99 ea.
15225	1970 All	13.99 ea.
14535	1971-77 All	18.99 ea.



Spare Fuse Power Wiring Extension

Used to add the functionality of the three extra spare fuses if desired.

39383	1968-69	29.99 ea.
-------	---------	-----------



Accessory Terminal & Connector Kit

Used to access the front of the ATO fuse block accessory ports, while maintaining the indexing capability of the cavities on the fuse block.

39384	1968-69	11.99 ea.
-------	---------	-----------



Glass Fuse Series Accessory Adapter Kit

Converts old accessory style indexed connectors to new ATO style connectors so you can plug your old accessories into your ATO fusebox with no modifications to connectors.

39385	1968-69	20.99 ea.
-------	---------	-----------



Fuse & Flasher Kit

Includes (2) flashers, (1) complete set of ATO fuses, plus (1) spare of each amperage.

39464	1968	17.99 ea.
39466	1969	17.99 ea.



Power Window Harness Boot

Manufactured from rubber as original these reproduction boots are designed to fit factory type power window harnesses.

GHB-4412	1967-69	54.99 pr.
----------	---------	-----------

**American Autowire
Classic Update Series Kits**



Classic Update complete wiring kits are made for the restoration enthusiast who wants some modern amenities in their classic vehicle. These kits include everything you need to modernize your classic vehicle: Headlight, Dimmer and Ignition Switches; Boots, Tubes and Grommets; Fuses, Relays and Flashers; Original Connectors, Terminals and Disconnects.



1967-73 Camaro

- NEW compact ATO-Style fuse panel.
- Original switch connector bodies
- Steering column connectors.
- Instrument cluster wiring.
- Rear body harness assembly plug.
- New floor dimmer switch.
- GM bulkhead connectors.
- Engine wiring.
- Front lighting.
- Original style light sockets!

500661	1967-68	629.99 ea.
500686	1969	647.99 ea.
510034	1970-73	593.99 ea.

Note: Does not support ammeters. Use 510121 voltmeter replacement for 1968 with original ammeter.



510121

1968-69 Console Voltmeter Gauge

These new Voltmeter gauges are engineered as a direct replacement to install in place of the factory Ammeter gauge that was used in the original saw tooth console gauge packages installed in many 1968-1969 Camaros. This gauge is a must when using American Autowire Classic Update or any other updated wiring harness, because those kits will not support the use of an Ammeter.

510121	1968-69	108.99 ea.
--------	---------	------------



35125

Ash Tray Lamp

Includes wire and socket. Does not include ash tray socket retainer. Original bracket and shield assembly must be reused.

35125	1967 All	13.99 kit
-------	----------	-----------



GBS-689

Blower Motor Switch

GBS-796	1967 w/ AC	69.99 ea.
GBS-68AC	1968 w/ AC	49.99 ea.
GBS-689	1967-68 w/o AC	29.99 ea.
GAC-385	1969 w/ AC	26.95 ea.
GBS-939	1969 w/o AC	29.99 ea.
GBS-70AC	1970-72 w/ AC	39.99 ea.
GBS-7081	1970-81 w/o AC	56.99 ea.
GBS-73AC	1973-81 w/ AC	49.99 ea.



ABR-71



ABR-69AC



ABR-77

Heater Blower Motor Resistors

Correct blower motor resistors.

ABR-71	1967-68 w/ AC	23.99 ea.
ABR-69AC	1969 w/ AC	29.99 ea.
ABR-77	1967-75 w/o AC	21.99 ea.
ARS-304	Mounting Screws	0.95 pr.



GBL-852



GBL-852-CC

Brake Light Switch

OE style brake light switches located above the brake pedal.

GBL-852	1967-81 All w/o Cruise Control	7.95 ea.
GBL-852-CC	1967-79 All w/ Cruise Control	19.95 ea.
GSR-12999	Retainer	8.99 ea.



GBL-9EB



GBL-99PC

Parking Brake Light Switch & Paddle Clip

Correct switch to activate parking light and special paddle clip to deactivate light when brake is off.

GBL-9EB	1967-69 Switch	19.95 ea.
GBL-99PC	1967-69 Paddle Clip	16.95 ea.



1967-68 Top Switch

Correct switch and housing for operation of power top.

GT-159	1967-68 Switch	32.95 ea.
GW-458	1967-68 Bracket w/ Clips	17.99 ea.



1969 Top Switch & Bezel

Correct switch and die cast bezel.

GT-69	1969 Switch	59.95 ea.
MTB-17	1969 Bezel	44.99 ea.
GW-082	1969 Bracket w/ Clips	17.99 ea.



Body Wiring Hold Down

Used to hold body harness to floor pan.

GHD-6472	All	4.95 ea.
----------	-----	----------

Note: Typically 3 required.



GDJ-11



GDJ-10



GDJ-3F

Door Jamb Switches

GDJ-11	Dual Pin (Male)	6.95 ea.
GDJ-10	Single Pin (Male)	7.95 ea.
GDJ-3F	Single Pin (Female)	8.99 ea.



GDT-0330

Electrical Harness Tape

Correct non-stick factory style tape. Over 100 feet.

GDT-0330	All	11.95 ea.
----------	-----	-----------



GQH-118

Electric Junction Block

Original GM junction block for attaching positive lead from battery to main harness. Mounts to radiator support. Includes correct nut.

GQH-118	1967-71 All	9.95 ea.
---------	-------------	----------



Engine Compartment Retaining Hooks

Pre-bent hooks for various wires, cables and hoses.

BCE-9738	Large Rubber Coated	4.95 ea.
APC-744	Small Hook (Oil Pan, etc.)	5.95 ea.
AHB-1X	Heater Box Wire Clip	4.95 ea.



Harness Retaining Clips

Correct retaining clips for harness.

AHC-1	Clip Style #1	4.95 ea.
AHC-2	Clip Style #2	4.95 ea.



Harness Retaining Straps

Correct push in style plastic retainers

BPX-2350	All	3.95 pr.
----------	-----------	----------



Harness Wire Ties

Original GM wire ties used for various hoses, cables and harnesses.

BJN-300	Short 5"	3.99 ea.
BJN-600	Long 7"	5.99 ea.



Glove Box Lamp

Complete assembly with socket, switch, bulb and correct harness, wires or terminals.

18000	1967-69 All	16.99 kit
36134	1970-79 All	19.99 kit
36136	1980-81 All	15.99 kit



Headlight Dimmer Switch

Correct floor mounted high beam switch.

GAC-808	1967-75 All	8.95 ea.
---------	-------------------	----------



Headlight Switch

GHS-588	1967 All, 1968 Standard	18.95 ea.
GHS-217	1969-81 Standard	18.95 ea.
GHS-542	1968-69 Rally Sport	54.99 ea.



Voltage Regulator Capacitor

GRC-12834	1967-72	29.95 ea.
-----------	---------------	-----------



Headlamp Switch Nut

Correct special nut used for retaining switch to the dash.

GHR-88	1969-81 All	10.99 ea.
--------	-------------------	-----------



Headlamp / Wiper Switch Ground Strap

Reproduction of the original headlamp and wiper switch ground strap.

GGG-69F	1969 All	12.99 ea.
---------	----------------	-----------

1967-68 High Beam Indicator

This is a reproduction headlamp hi beam indicator bulb housing, red lens and ground strap. Mounts on the upper portion of the rear section of the plastic instrument carrier. The ground strap is instrumental in grounding the hi beam indicator light and gauge cluster assembly. Includes mounting screws. Bulb and wiring are not included.



GAC-6768	All	49.99 set
----------	-----------	-----------



Ignition Switch

GIS-821	1967 All	23.95 ea.
GIS-152	1968 All	18.95 ea.
GIS-042	1969-81 w/o Tilt	29.95 ea.
GIS-052	1969-81 w/ Tilt	26.99 ea.



Ignition Switch Nut

Correct heavy chrome nut for retaining switch to dash.

IQ-507	1967-68 All	8.99 ea.
--------	-------------------	----------



Neutral Safety Switch

Correct switch at base of steering column for proper engine & reverse light activation.

GNQ-375	1967 TH350/400 w/ Console	39.99 ea.
GNS-503	1967 Powerglide w/ Console	41.99 ea.
GNS-23	1967-68 TH	21.99 ea.
GNS-33	1969-73 4 Speed	49.99 ea.
GNS-35	1969-73 On Column	16.99 ea.
GDR-411	1969-73 Auto	21.95 ea.



Neutral Start Switch

Correct safety switch located at pedal which prevents your car from being started in gear.

GNS-1969	1969 4 Speed	59.95 ea.
FSR-372	Rod & Clip	16.99 ea.



Turn Signal & Hazard Light Switch

Correct flasher switch that plugs into fuse box.

GFS-502	1967-81	11.95 ea.
---------	---------------	-----------



Power Window Switch

Correct OEM style power window switch.

4432790	1967-70 1 Window	39.95 ea.
4432791	1967-70 4 Window	63.95 ea.
GWS-711	1971-81 1 Window	39.95 ea.
GWS-712	1971-81 2 Window	49.95 ea.



Reverse Lamp Switch

1993413	1967-68 Switch	74.99 ea.
10665	1967-68 Switch Extension	23.99 ea.



GTS-304

Turn Signal Switches

Complete switch assemblies with correct plug in harnesses.

GTS-304	1967-68 All	49.95 ea.
GTS-6208GM	1969-76 All	64.99 ea.
GTS-6208	1969-76 All	46.99 ea.
GTS-6265	1977-81 All	61.95 ea.



GTR-305

Turn Signal Repair Switch

Correct white plastic repair arm that the turn signal handle attaches to.

GTR-303	1967-68 w/o Tilt	11.95 ea.
GTR-301	1967-68 w/ Tilt	12.95 ea.
GTR-305	1969-76 All	14.95 ea.



GWC-SPK

Speaker/Trunk/Blower Motor Wire Clips

Used to hold the wiring under the dash, power trunk or trunk light wires to hinge, speaker wires to package tray or blower motor wire to vent.

GWC-SPK	1964-77 All	13.95 pr.
---------	-------------	-----------



GPC-68

Printed Circuit Boards

OE style reproduction circuit boards.

w/ Gauges

GPC-67	1967 All	72.95 ea.
GPC-67	1968 w/o Tach	72.95 ea.
GPC-68	1968 w/ Tach	79.99 ea.
GPC-676	1970-81 All	69.95 ea.

w/ Warning Lights

GPC-67W	1967-69 All	72.95 ea.
GPC-739W	1970-79 All	72.95 ea.
GPC-801W	1980-81 All	72.95 ea.



GRC-12835



GRC-12834

Radio Capacitor

Came from the factory on all cars with a radio. Correct length lead wire & brass connector.

GRC-12834	1967-71 Voltage Regulator	29.95 ea.
	<i>Stamped 1964086 "DR" & ".5MF"</i>	
GRC-12835	1970-1974 Radio	29.95 ea.
	<i>1964452 "DR" & ".3MF"</i>	



AMH-15

Underhood Lamp

Complete with bracket, hardware, harness and built in switch.

AMH-15	All	39.99 kit
--------	-----	-----------



GAC-515



GAC-515GM

Voltage Regulator

New correct GM replacement.

GAC-515	1967-72 All D635	79.95 ea.
GAC-515GM	1967-71 OE style Reproduction	89.95 ea.
AVX-515	1967-72 Screws 2pc	0.95 kit
AWX-818	1967-72 Mounting Kit	6.95 kit



GWS-103

Wiper Switch

GWS-103	1967-68 All	41.99 ea.
GWS-106	1969 All	46.99 ea.
GWS-108	1972-74 w/o Hidden Wipers	79.99 ea.



GRW-016

Circuit Breaker

Correct 30 amp breaker used for power windows, power doors and power tops.

GRW-016	1967-69	17.99 ea.
GRW-016	1973-79	17.99 ea.



ATCS-33R

TCS Littlefuse Relay

Features 4 prongs as original and replaces Delco number 3961573.

ATCS-33R	1970-72	54.95 ea.
----------	---------	-----------



GRA-8172

Air Conditioner Relay

Correct GM blower motor relay.

GRA-8172	1967-68 w/ AC	22.95 ea.
GRA-885	1969-76 w/ AC	54.99 ea.



AEH-9602

Cowl Induction Relay

New GM relay which mounts to firewall.

AEH-9602	1967-69 w/ CI	27.99 ea.
----------	---------------	-----------



GAC-723

Horn Relay

New reproduction of the original GM Delco style relay.

GAC-723	1967-71	52.95 ea.
GAC-775	1972-73	54.95 ea.
AVN-506	Mounting Screw	0.95 ea.



GSR-6076

Power Seat Relay

For cars with 4 or 6 way power seat. 6 prong. Replaces GM 5717528.

GSR-6076	1967-76	59.95 ea.
----------	---------	-----------



GWR-772

Power Window Relay

Correct reproduction of this hard to find relay.

GWR-772	1967-72	42.95 ea.
---------	---------	-----------



1967 Rally Sport Circuit Breaker

OE style reproduction 10 amp circuit breaker including correctly plated mounting bracket, two correct style integral washer nuts to attach wiring connectors.

KB-10 1967 RS24.99 ea.



1967 Rally Sport Headlamp Limiting Switch

Correct headlamp limiting switch with correct attached ground wire.

KRO-205 1967 RS Switch23.99 ea.
KRX-398 1967 RS Screw Kit8.99 kit



Ground Strap Kit

Correct braided copper wire and ends complete with OEM screws

APJ-5240 1967-68 3pc19.95 kit
APJ-5230 1969 4pc23.95 set



1967 Rally Sport Relay Board Assembly

Complete reproduction assembly with all correct parts. Die stamped steel relay mounting plate with three installed relays.

KW-806 1967 RS99.99 kit



1967 Rally Sport Headlamp Relay

Excellent reproduction headlamp relay with stamped Delco Remy script. Mounting bracket includes stamped 858 numerals with accurate finish plating.

KRG-398 1967 Motor Relay24.99 ea.
KRG-215 1967 Bracket32.99 ea.



Tune Up Kit

AC Delco tune up kit with new points, condenser and rotor.

N-2441 1962-74 w/o HEI45.95 ea.



Alternator Pigtail & Boot

Correct plug in "pigtail" for rear of alternator.

AVC-1144 1967-81 All Pigtail4.95 ea.
APX-2559 Rear Alternator Boot4.95 ea.



R59-TOP



R89-TOP

Battery Toppers

This new plastic injection molded cover will give your modern battery the look and feel of an original! This topper works with Group 24-60 sized batteries only. Inside size = 6-7/8 x 10-3/8.

R59-TOP 1967-72 R-5944.95 ea.
R89-TOP 1969-72 R-89 Side44.95 ea.



Spring Ring Cables

OE style reproduction of the original factory installed spring type cables sold as a matched pair with GM numbers.

ASR-678FSB 1967-68 SB118.98 pr.
ASR-678FBB 1967-68 BB118.95 pr.
ASR-69FSB 1969 SB118.95 pr.
ASR-69FBB 1969 BB118.92 pr.
ASR-70F 1970-73 All89.00 pr.



Side Terminal Battery Cables

Correct cables for cars with the heavy duty R-89 batteries with correct GM part numbers.

AST-1001 1969 R-8999.99 kit



A2525

1971244



Distributor Cap

Choose from AC Delco replacement distributor cap or exact reproduction distributor cap with GM numbers. Red cap features heavy duty brass terminals for high performance engines.

A2525 Red Cap79.95 ea.
1971244 Black Cap69.95 ea.
AAD-308 Replacement22.95 ea.



ADS-2100-SC-CLEAR



ADS-2100-SC-RED

HEI Distributor

HEI Electronic Distributor with 50K Coil - Red Cap

ADS-2100 All72.99 ea.
ADS-2100-SC-RED Red Super Cap102.99 ea.
ADS-2100-SC-CLEAR Clear Super Cap108.99 ea.
ACE-1400 All V8 Hold Down4.95 kit



1115263 (Top View)

1115270



Coil

Choose from our new exact reproduction Delco coils with GM numbers or GM replacement coil.

1115287	1968-72 BB.....	139.95 ea.
1115270	1968-72 SB.....	139.95 ea.
1115263	1967-72 Trans. Ign.*.....	149.95 ea.
1115293	1970-72 Most V8.....	139.95 ea.
GAC-505	1962+ Most Replace.....	39.95 ea.

*427/454 transistor ignition. No Volume Discount.



AHC-1508

Spark Plug Wire Sets

Pre-cut factory replacements.

AHC-1508	1967-73 SB non-HEI.....	39.95 set
AHC-2508	1967-72 BB non-HEI.....	39.95 set
AHC-3508	1974-81 with HEI.....	52.95 set



ALL-70BB3Q

"Dated" Spark Plug Wire Set

New OE style reproduction wire set correctly dated for your specific car, pre-cut and ready to install! Each set features correct colored wires and correct angled boots. Please give your sales rep your desired date. For points style, non-HEI cars only.

Here's how to order:

ALL-(year)(block)(quarter)..... 79.99 set

*For example, a 1970 Camaro SS396 built on or before Jan.

15, 1970, you would order ALL-70BB3Q wires will have 3-Q-69 stamped on them. If built after Jan. 15, 1970, you would order ALL-70BB1Q.



AC43

AC Delco Spark Plugs

This is a brand new set of 8 spark plugs. These high quality reproduction AC Delco spark plugs feature the correct green AC and markings as original.

AC43	1964-70 #43.....	59.95 set
AC44	1964-70 #44.....	59.95 set
AC45	1964-70 #45.....	59.95 set

Note: The number on the plug refers to it's operating temperature. The lower number is a cooler running plug which is typically found on the SHP high performance engines. A hotter, higher numbered plug would be used in engines where plug fouling may be or is a problem.



ACI-3685

Cowl Induction Electric Solenoid

Correct electric solenoid with part number stamped on.

ACI-3685	1967-69 w/ GM Stamp.....	36.99 ea.
----------	--------------------------	-----------

AD-007



AQW-1176

Cowl Induction Solenoid Switch

Correct throttle switch and clip for activating solenoid.

AQW-1176	1967-69 Switch.....	19.99 ea.
AD-007	1967-69 Clip.....	5.99 ea.



AHQ-1143

AQW-296

Cowl Induction Harness & Grommet

OE style reproduction of original GM harness and correct rubber grommet for routing harness through firewall.

AHQ-1143	1967-69 Harness.....	42.99 ea.
AQW-296	1967-69 Grommet.....	8.99 ea.



ACY-100

Marking Crayons

Original crayons used to mark the frame and firewall. Includes (1) yellow crayon and (1) white crayon.

ACY-100	All.....	5.99 kit
---------	----------	----------



GAC-560

GAC-760

GAC-660

Temp Sending Units

Correct screw in sending units.

GAC-250	1967-72 w/o Gauges.....	16.95 ea.
GAC-560	1967-72 w/ Gauges.....	16.95 ea.
GAC-760	1969-70 w/ Gauges.....	32.95 ea.
GAC-660	1970-72 TCS Sender.....	18.95 ea.
CPX-999	1967-72 w/ Gauges.....	12.95 ea.



GSS-883

Side Marker Socket

GSS-883	1968-79.....	5.95 ea.
GSS-893	90 Degree Side Marker Socket.....	5.95 ea.



GLS-154

Tail Lamp Socket

GLS-157	1962-68.....	8.95 ea.
GLS-154	1969-79.....	11.95 ea.
GLS-70	Tail Lamp Socket 2nd Design.....	11.95 ea.



Power Door Lock Switch

Correct reproduction power door lock switch.

GLS-71	1971-77.....	59.95 ea.
--------	--------------	-----------



ACY-KIT

Frame & Body Marking Crayon Kit

These paint sticks are used for final detailing to replicate the marks left on the frame, body and other parts of the car. Just like when it came down the assembly line!

ACY-KIT	All 12pc.....	22.99 kit
---------	---------------	-----------

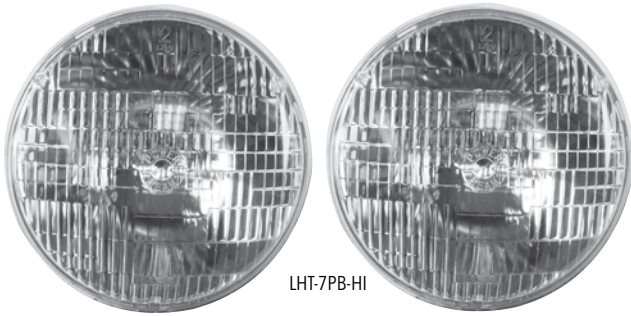

LHT-7PB-HI



LHT-7T-HI Detail



FACTORY T3

HI-INTENSITY T3



LHT-7PB-HI Detail

T-3 Headlamps

Upgrade your weak old original T3 and Power Beam headlights with a pair of high performance headlights from Ground Up! These headlamps utilize modern bulb filaments with a much brighter high/low beam, which are considerably brighter than the original factory and Power Beam units. These fit and function exactly as original which makes installing these a breeze. They feature a T3or Power Beam logo and look just like the originals! We tested these on our own 1969 Camaro in our warehouse and you can really see the difference!

LHT-7PB-HI	1967-81 All Power Beam	129.99 pr.
LHT-7T-HI	1967-81 All T3	129.99 pr.



Ground Up Pro-Touring Restomod LED Headlight Conversion Kit

Upgrade the look of your 1967-1981 Camaro headlights with Ground Up's brand new Exclusive Plug n' Play DOT approved headlight kit by Aroara. This easy to install headlight kit comes with everything you need for a simple install. With our included modified headlamp buckets no welding, cutting or intense fabrication is required. This Exclusive kit is one of the only true Plug n' Play kits on the market for your Chevrolet. Ground Up's Exclusive Aroara LED headlights are equipped with a high and low beam with a color temperature of 6000k which produces a crisp white light which greatly assists in lighting things up for you like never before. This light is also equipped with a half circle driving light (DRL) that easily integrates into your factory parking light system. You will not find a set of headlights for your Chevrolet Camaro like this anywhere else! This kit comes complete with everything you need to convert your standard headlights to a set of new Ground Up Exclusive Aroara LED headlights.



This Kit Includes:

- A pair of Aroara LED headlights
- 2 modified headlamp buckets designed to house the new LED lights
- 2 retaining springs that work with the modified bucket
- An extra wire for the day time running light halo rings

Features:

- High and Low beam color temperature of 6000k
- True Plug & play installation
- Easy Integrating Half Circle Driving Light (DRL)
- DOT & Transport Canada compliant for on-road use

ARA-7K	1967-69 All Black.....	299.95 kit
ARA-7073K	1970-73 All Black.....	299.95 kit
ARA-7481K	1974-81 All Black.....	299.95 kit

No volume discount.



JW-0554543-BLK

JW-0554543-CRB

JW Speaker Pro-Touring Restomod LED Headlight Conversion Kits

Ground Up's exclusive high performance 7 inch round Camaro LED headlight offers dual-burn high & low beam optics. This technology combines your high and low beam when turning on your high beam, providing the driver with both widespread visibility along with a powerful punch of light down the road. The Model 8700 Evolution J2 Series offers a new technology that we call Dual Burn, giving our drivers that powerful punch of light they are looking for at night, while maintaining the widespread visibility - lighting things up for you like never before. You will not find a set of headlights for your Camaro like this anywhere else. This kit comes complete with everything you need to convert your standard headlights to the new LED JW Speaker headlights.

This Kit Includes:

- A pair of JW Speaker 8700 EVO J2 headlights
- 2 modified headlamp buckets designed to house the new LED lights
- 2 retaining springs that work with the modified bucket
- 2 wiring harness adapters

JW-0554543-BLK	1967-69 All Black	734.24 kit
JW-0553973-CRB	1967-69 All Carbon	736.99 kit

No volume discount.



LHR-10K



LHR-663

Headlamp Retainer

Correct stainless steel rings and attaching screws.

LHR-663	1967-75 All	13.95 ea.
LHR-39	1976-81 All	24.99 ea.
LHR-10K	Screws 3pc	0.95 kit



LHA-69K

Headlamp Adjustment Kit

Plastic nuts and screws for headlamp adjustment. Each kit does one car.

LHA-678K	1967-1968 10pc.....	13.99 kit
LHA-69K	1969 10pc.....	15.95 kit
LHA-70K	1970-73 10pc.....	15.99 kit
LHA-81K	1974-81 4pc.....	5.95 kit

LHS-67



Headlamp Spring

Correct spring used for proper adjustment.

LHS-67	1967-69 All	2.99 ea.
LHS-73	1970-73 All	3.99 ea.
LHS-81	1974-81 All	2.99 ea.



LHH-67SL



LHB-67R

Headlamp Mounting Buckets

OE style reproduction headlamp buckets which attach to the headlamp housings and keep the headlights in place.

LHB-67R	1967-69 RH.....	26.99 ea.
LHB-67L	1967-69 LH.....	27.99 ea.
LHB-67R	1967-69 RS RH.....	26.99 ea.
LHB-67L	1967-69 RS LH.....	27.99 ea.
LHB-67K	1967-69 All	46.73 kit
LHB-988	1970-73 RH.....	34.99 ea.
LHB-989	1970-73 LH.....	34.99 ea.

Headlamp Housings

These correct headlight housings attach to the radiator support and hold the headlight components in place. 1967 Rally Sport includes motor plate.

LHH-67SR	1967 Std RH.....	39.95 ea.
LHH-67SL	1967 Std LH.....	39.95 ea.
LHH-67RR	1967 RS RH.....	49.99 ea.
LHH-67RL	1967 RS LH.....	49.99 ea.
LHH-68R	1968 Std RH.....	39.95 ea.
LHH-68L	1968 Std LH.....	39.95 ea.
LHH-68RR	1968 RS RH.....	49.99 ea.
LHH-68RL	1968 RS LH.....	49.99 ea.
LHH-69R	1969 Std RH.....	39.95 ea.
LHH-69L	1969 Std LH.....	39.95 ea.
LHH-69RR	1969 RS RH.....	49.99 ea.
LHH-69RL	1969 RS LH.....	49.99 ea.
LHH-897	1970-73 RH.....	34.95 ea.
LHH-899	1970-73 LH.....	34.95 ea.



LPH-120KIT



LPH-970KIT

Parking Lamp Kits

Correct parking lamp assemblies complete with lens, housing and bulb. Kits include one left and one right side assembly

LAMP-KIT67FS	1967 Standard.....	111.58 kit
LPH-290K	1967 Rally Sport.....	92.67 kit
LAMP-KIT68FS	1968 Standard.....	80.98 kit
LPH-350K	1968 Rally Sport.....	78.27 kit
LPH-120KIT	1969 Standard.....	93.48 pr.
LPH-169K	1970-73 Standard.....	143.98 kit
LPH-970K	1970-73 Rally Sport.....	125.98 kit



LPH-439L



KC-596

1967 STD Parking Lamp Assembly & Brackets

Complete parking lamp assembly with lens, bulb and socket.

LPH-439L	1967 Std LH.....	61.99 ea.
LPH-439R	1967 Std RH.....	61.99 ea.
KC-596	1967 RS Brackets.....	19.99 pr.
LHS-207	1967 Housing Seals.....	7.99 pr.



LPH-896

1968 STD Parking Lamp Assemblies

Complete parking lamp assembly with clear lens, stainless trim, amber bulb and wire.

LPH-896	1968 Standard.....	44.99 ea.
---------	--------------------	-----------



LPH-120

1969 STD Parking Lamp Assemblies

Complete parking lamp assembly featuring housing, clear lens, amber bulb and wiring with connector. RS trim sold separately.

LPH-120	1969 All	54.99 ea.
---------	----------------	-----------



LPH-970



LPH-169

1970-73 RS/STD Parking Lamp Assemblies

OE style reproduction parking lamp assembly including the lens, housing, lens gasket, bulb, grommet and wire lead.

LPH-970	1970-73 RS*	69.99 ea.
LPH-169	1970-73 Std LH.....	79.99 ea.
LPH-170	1970-73 Std RH.....	79.99 ea.

* Correct SAE & Guide Markings



LPH-290L

1967 RS Parking Lamp Housings

This OE style reproduction housing features the correct color wiring, plug in harness with rubber grommet and bulb.

LPH-290L	1967 RS LH.....	42.99 ea.
LPH-290R	1967 RS RH.....	42.99 ea.



LPH-350L

1968 RS Parking Lamp Housings

OE style reproduction die cast housings with bright white enamel inlay. Includes rubber bumper, bulb, correct color wiring with grommet, crimped harness sleeve and connector.

LPH-350L	1968 LH.....	34.99 ea.
LPH-350R	1968 RH.....	34.99 ea.

Parking Lamp Lenses

If your original housings and wires are okay, we offer replacement lenses so you don't have to replace your whole assembly.



LPL-145

LPL-145	1967 Standard.....	10.99 ea.
---------	--------------------	-----------



LPL-437

LPL-437	1968 Standard w/Trim.....	16.99 ea.
---------	---------------------------	-----------



LPL-437

LPL-681	1967-68 Rally Sport.....	16.99 pr.
---------	--------------------------	-----------

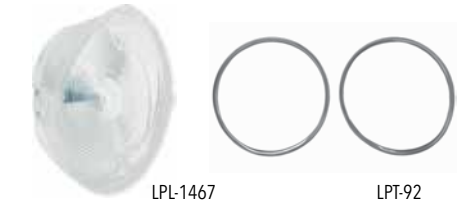

LPL-1467 1969 All 11.99 ea.
LPT-92 1969 RS Trim..... 12.99 pr.



LK-332 1970-73 Standard..... 37.99 pr.
LPT-393 1970-73 Std Trim 32.99 pr.



LPL-70RS 1970-73 RS Lens w/ Trim 82.95 ea.



LPL-168 1974-77 All 29.99 ea.
LPT-452 1974-77 Chrome Trim..... 26.99 ea.



LPL-683 1978-81 Non Z/28 36.99 ea.
LPL-913 1978-81 Z/28 49.99 ea.



Parking Lamp Gaskets
Correct sponge material as original.

LG-281 1967 Standard..... 6.99 pr.
LG-282 1968 Standard..... 6.99 pr.
LG-227 1967-68 RS..... 6.99 pr.
LG-229 1969 All 6.99 pr.
LG-53 1970-73 Standard..... 16.99 pr.



Parking Lens Screws
Correct long shaft screws in complete kits.

LTS-11 1967-68 RS All 4pc..... 4.99 kit
LTS-16 1969 All 6pc..... 6.99 kit
LTS-696 1970-73 Std 8pc..... 9.99 kit



DT-2100167 DT-2100267

Digi-Tails LED Parking Light Kits
Enhance your front lights with high intensity LEDs that maximize light output, making your lights safer and brighter.

DT-2100167 1967 Std 99.95 kit
DT-2100168 1968 Std 99.95 kit
DT-2100267 1967-68 RS..... 99.95 kit
DT-2100169 1969 All 109.95 kit
DT-2100270 1970-73 RS..... 109.95 kit

Note: If LED front parking lights are the ONLY LED lights you are installing then you do not need an electronic LED flasher. If you are installing both LED tail light AND LED front lights then two electronic LED flashers are required. Housing and lenses are not included.

DT-200010



LED Turn Signal Bulbs
These LED light bulbs are the perfect complement to your new Digi-Tails tail lights for applications where specific parking light kits are not available.

DT-200010 1157 LED Amber Bulb 19.95 ea.
DT-200015 1157 HP LED Amber Bulb, 11 Watt 31.95 ea.

GSS-883



Side Marker Sockets
Correct side marker sockets.

GSS-883 1968-81 All 5.95 ea.

LPH-120CX



Parking Lamp Harness Clip
Mounts the bumper bracket for standard or RS models.

LPH-120CX 1969 All 10.95 ea.

DT-200002



Electronic LED Flasher
This electronic LED flasher is recommended for use with LED tail lights and parking lights.

DT-200002 LED Flasher 2 Prong 19.95 ea.

DT-200008



LED Side Marker Bulbs
A simple direct replacement for your side marker light bulb. This red LED bulb features 6 super bright LEDs in a 194/T10/160 bulb package. Excellent to increase brightness and reduce heat and power consumption.

DT-200008 194 Red LED Bulbs..... 15.95 pr.
DT-200009 194 Amber LED Bulbs 15.95 pr.

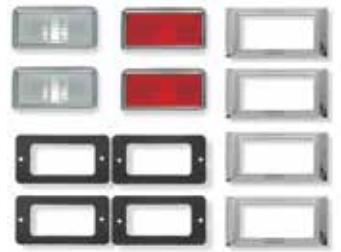

1968 Side Markers
Our complete side marker kit includes (2) front clear lenses, (2) rear red lenses, (4) chrome bezels and (4) gaskets. Individual components are also available separately.

LSM-68K Complete 49.40 kit
LSM-9885 Front Clear Lens..... 6.95 ea.
LSM-9916 Rear Red Lens..... 6.95 ea.
LSB-459 Bezel 6.99 ea.
LSG-X68 Gaskets 4pc..... 5.99 kit
CT-826 Rear Template 15.99 ea.

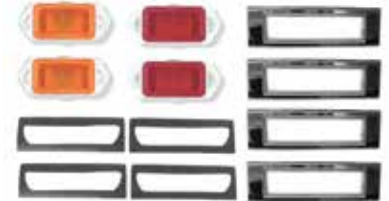

1969 Side Markers
Our complete side marker kit includes (2) front amber lenses, (2) rear red lenses, (4) chrome bezels and (4) gaskets. Individual components are also available separately.

LSM-69K Complete 69.62 kit
LSM-6813 Front Lens..... 11.99 ea.
LSM-6847 Rear Lens..... 11.99 ea.
LSB-715 Front Bezel 6.99 ea.
LSB-269 Rear Bezel 6.99 ea.
LSG-302 Gaskets 4pc 5.99 ea.



1970-78 Side Marker Lenses
Correct reproduction lenses with SAE and Guide lettering.

LSM-140 1970-77 Front Amber 22.99 ea.
LSM-180 1978-81 Front Amber 23.99 ea.
LSM-160 1970-73 Rear Red..... 21.99 ea.



1970-81 Side Marker Lamp Retainer
Correct retainer used to hold the side marker lamp assembly to the fender.

LMR-545 1970-81 All 5.99 ea.



1978-81 Side Marker Lamp Bezel
OE style reproduction side marker lamp bezel.

LSB-120 1978-81 All 9.99 ea.



1967 Tail Light Bezels

Beautiful die cast reproduction tail light bezels featuring bright outer chrome trim and matte black painted inner area as original.

LTB-7840 1967 All 139.99 pr.



1968 Tail Light Bezels

Beautiful die cast reproduction tail light bezels featuring bright outer chrome trim and matte black painted inner area as original.

LTB-652 1968 All 139.99 pr.

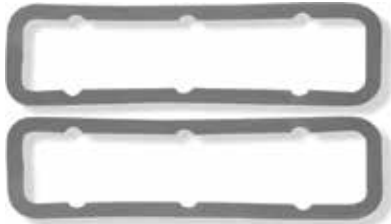

1967-68 Bezel Gaskets

Correct gaskets to seal the tail lamp bezels to the tail panel.

LGB-652 1967-68 All 24.99 pr.



1967-68 Tail Light Bezel Backing Plates

OE style reproduction stamped steel tail lamp backing plates with text stampings.

LBP-088 1967-68 All 79.99 pr.



1967 Standard Brake & Reverse Lens

Correct tail lamp brake and reverse lenses which features the word "Guide".

LTL-392 1967 Brake 13.99 ea.
LTL-193 1967 Reverse 11.99 ea.



1968 Standard Brake Lens

Correct tail lamp brake and reverse lenses which features the word "Guide".

LTL-390 1968 Brake 13.99 ea.
LTL-391 1968 Reverse 13.99 ea.



1967-68 Rally Sport Tail Lens

Correct tail lamp brake lens which features the word "Guide".

LTL-118 1967 Rally Sport 18.99 ea.
LTL-130 1968 Rally Sport 18.99 ea.



1967-68 Tail Lens Gaskets

Correct gaskets to seal the tail lenses to the backing plates.

LTG-151 1967-68 9.99 pr.



1969 Standard Tail Lens

Excellent reproduction standard tail lenses which includes the correct stainless trim moldings which separate the three sections.

LTK-283L 1969 Standard LH 49.99 ea.
LTK-283R 1969 Standard RH 49.99 ea.
LTK-283K 1969 Pair 89.98 kit



1969 Rally Sport Tail Lens

Excellent reproduction Rally Sport tail lenses which includes the correct stainless trim around the outer edge.

LTL-114L 1969 Rally Sport LH 64.99 ea.
LTL-114R 1969 Rally Sport RH 64.99 ea.
LTL-114K 1969 Pair 116.98 kit

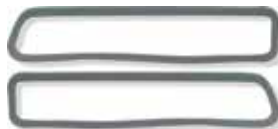

1969 Tail Lens Gasket

Used to seal tail lens housing to body and tail lens to housing. Two pairs required per car. Choose from replacement injection molded foam or correct molded reproductions.

LTG-153 Replacement 14.99 pr.
LTG-153GM Molded Repro 22.99 pr.



1969 Tail Lamp Housings

OE style reproduction plastic tail lamp housings with correct reflective silver color.

LTH-565L 1969 Std LH 62.95 ea.
LTH-565R 1969 Std RH 62.95 ea.
LTH-6RR 1969 RS LH 62.95 ea.
LTH-6RL 1969 RS RH 62.95 ea.



1969 Side Marker Nut Set

Eight pal type self threading nuts for side marker post diameters of 3/16 inch.

LSM-777A 1969 All 6.99 ea.



1969 Tail Lamp Stud & Nut Set

This kit contains five screws with nuts to mount one tail lamp housing.

LHK-382 1969 All 14.99 kit

Note: Two kits required per car.



Eddie Motorsports Billet Tail Lights

M = Machined, P = Polished, CL = Clear Coat, BKA = Gloss Black Anodized, CA = Clear Anodized, BK = Gloss Black Finish, MBA = Matte Black Finish

		M, P	All Others
MS275-40K_	1967 RS Billet LED Tail Light Kit	617.99 pr...	674.99 pr.
MS275-42K_	1968 Billet LED Tail Light Kit	617.99 pr...	674.99 pr.
MS275-45_	1969 RS Billet Tail Light Kit	257.99 pr...	321.99 pr.
MS275-44_	1969 Standard Billet Tail Light Kit	257.99 pr...	321.99 pr.
MS275-46_	1969 Standard Billet Tail Light Kit w/ Reverse	257.99 pr...	321.99 pr.
MS275-40_	1967 RS Tail Light Bezels Only	455.99 pr...	515.99 pr.
MS275-42_	1968 Billet Tail Light Bezels Only	455.99 pr...	515.99 pr.



Digi-Tails Tail Lights

DIGITAILS

Dramatically enhance your tail lights with safer, brighter and fully sequential LED light-panels that are easy to install.

DT-1100167	1967 Std	199.95 kit
DT-1100167R	1967 Std w/ LED Rev	219.95 kit
DT-1100267	1967-68 RS	219.95 kit
DT-1100169	1969 Std	249.95 kit
DT-1100269R	1969 Std w/ LED Rev	309.95 kit
DT-1100269	1969 RS	299.95 kit
DT-1100170	1970-73 2 Panels	199.95 kit
DT-1100270	1970-73 4 Panels	299.95 kit
DT-1100270R	1970-73 4 Panels w/ Rev	319.95 kit
DT-1100174	1974-77	199.95 kit
DT-1100186	1986-92	319.95 kit

Note: An electronic LED flasher is highly recommended for use with Digi-Tails tail lights but may not be necessary. If you are installing both LED tail light AND LED front lights then two electronic LED flashers are required. Housing and lenses are not included. Digi-Tails LED tail light kits are designed to fit your existing housing and lenses perfectly.



Dakota Digital LED Tail Light Conversion Kit

Dakota Digital LED lighting systems are engineered to utilize your existing wiring harness, tail light lens and assembly. Whether you have OEM wiring or have updated to a new style harness, installation is effortless! LED modules are included for both left and right rear brake lights. Dakota Digital Tail Lights include the LED brake / tail light modules, wiring and moisture resistant crimp on connectors. Dakota Digital LED Tail Light Modules are backed by a Limited Lifetime Warranty.

LAT-NR100	1967-68 Std	180.99 kit
LAT-NR101	1967-68 RS	199.99 kit
LAT-NR111	1969 All	313.99 kit
LAT-NR100	1970-73 All	180.99 kit
LAT-NR170	1974-77 All	218.99 kit

*Does not include lenses, housings or gaskets.
No Volume Discount*



DIGITAILS

LED Reverse Bulbs

These LED reverse light bulbs are the perfect complement to your new Digi-Tails LED tail lights.

DT-200005	1156 LED Reverse Bulb	19.95 ea.
DT-200014	1156 HP LED Reverse Bulb 11 Watt	32.95 ea.



1970-73 Tail Lamp Kit

Rally sport lenses with a chrome Center Ring.

1st Design

LTR-530	1970-71 STD	95.99 kit
LTR-528	1970-71 RS	99.99 kit

2nd Design

LTR-529	1971-73 STD	84.99 set
LTR-531	1971-73 RS	92.99 set



1970-73 Complete Tail Lamp Housings

OE style set of reproduction complete tail lamp housings to replace your cracked or missing originals.

LTH-703R	1970-73 RS	279.95 set
----------	------------------	------------



1970-73 Tail Lens Gaskets

Correct set of four tail lens gaskets.

LTG-703	1970-73	32.99 pr.
---------	---------------	-----------



1974-77 Tail Lamp Lens

Authentic reproduction. Made in USA.

LTR-747FL	1974-77 LH	114.95 ea.
LTR-747FR	1974-77 RH	114.95 ea.



1974-77 Tail Lamp Gaskets

Correct gaskets. Made in USA.

LTG-747FL	1974-77 LH	25.95 ea.
LTG-747FR	1974-77 RH	25.95 ea.



LTR-313



LTR-777



LTR-259

1978-81 Tail Lamp Lens

OE style reproduction tail lamp lenses for standard/Berlinetta or Z/28. Correct tint as original.

LTR-313	1978-81 Standard LH	136.99 ea.
LTR-314	1978-81 Standard RH	136.99 ea.
LTR-777	1979-81 Berlinetta LH	160.99 ea.
LTR-778	1979-81 Berlinetta RH	160.99 ea.
LTR-259	1978-81 Z/28 LH	144.99 ea.
LTR-260	1978-81 Z/28 RH	144.99 ea.



LTG-311



LTG-312



LTG-326



LTG-327

1978-81 Tail Lamp Gaskets

Correct gaskets for sealing your tail lamp housings to the tail panel and tail lenses to tail lens housing.

LTG-312	1978-81 to Housing RH	27.99 ea.
LTG-311	1978-81 to Housing LH	27.99 ea.
LTG-326	1978-81 to Body RH	29.99 ea.
LTG-327	1978-81 to Body LH	29.99 ea.



1978-81 Tail Lamp Socket Housing Foam Washer Kit

This is a correct 6 piece tail lamp socket housing foam washer kit.

JSS-C214	1978-81	7.99 kit
----------	---------------	----------



1978-81 Tail Lamp Rear Stud/Wing Nut Kit

This is a correct 24 piece tail lamp stud and wing nut seal kit.

JSS-C219 1978-81 24pc.....12.99 kit



Tail Lamp Socket

Correct replacement tail lamp sockets.

GLS-157 1967-68 2 Wire 8.95 ea.
 GLS-154 1969-81 3 Wire 11.95 ea.
 GLS-70 1969-81 2 Wire Single Element.... 11.95 ea.



1967-68 Rally Sport Reverse Lens Housing

OE style reproduction RS backup lamp housings. Housings are polished chrome and include bulb socket with lead and molded boob.

LHA-467L 1967-68 RS LH.....39.99 ea.
 LHA-467R 1967-68 RS RH39.99 ea.
 LHA-467K 1967-68 RS.....71.98 kit



1967-68 RS Backup Housing Gasket

Correct die molded neoprene rubber gaskets for sealing back up assembly to tail pan.

LBG-237 1967-68 RS.....6.99 pr.



1967-69 RS Backup Lens Screws

OE style reproduction chrome shouldered screws for backup lenses.

LBS-292 1967-68 Rally Sport 4pc.....5.99 kit
 LTS-11 1969 Rally Sport 4pc.....4.99 kit



1967-68 Rally Sport Reverse Lens

Correct clear reverse lens for RS models featuring the word "Guide".

LBL-81 1967-68 RS.....7.99 ea.



1967-68 RS Backup Lens Gasket

Correct thick die cut grey rubber for sealing lenses to housings.

LBG-284 1967-68 RS.....6.99 pr.



1969 RS Backup Housing Gasket

Correct die molded neoprene rubber gaskets for sealing back up assembly to tail pan.

LBG-652 1969 RS.....7.99 pr.



RS Backup Lens Mounting Template

Correct template which shows the correct tail panel hole locations for the RS backup lamp housings.

CT-724 1967-68 RS.....34.99 ea.
 CT-727 1969 RS34.99 ea.



1969 Rally Sport Reverse Lens Housing

Accurate chromed die-cast reproduction with white enamel inlay as original. Includes housing, wiring, rubber boot, grommet, bulb and connector.

LHA-630L 1969 RS LH42.99 ea.
 LHA-630R 1969 RS RH.....42.99 ea.

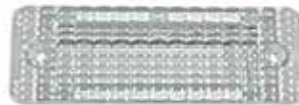

1969 Rally Sport Reverse Lens

Accurate reproduction clear backup lens with correct markings.

LBL-500 1969 Rally Sport 13.99 ea.



1969 RS Backup Lens Gasket

Correct thick die cut grey rubber for sealing lenses to housings.

LBG-285 1969 RS.....6.99 pr.



Exterior Bulb Kits

Vehicle specific kits include (2) Stop/Tail/Turn, (2) Reverse, (1) License, (2) Park/Turn Signal, (4) Side Marker (Except 1967).

BULB-67FX 196714.95 kit
 BULB-71AX 196814.95 kit
 BULB-69FX 1969-72 14.95 kit
 BULB-69AX 197314.95 kit



1967-69 License Plate Lamp

Correct license plate lamps and gaskets.

MEH-1576 1967-69.....19.95 ea.
 LPL-338 Lens Only 7.99 ea.
 LPL-1G Gasket Only..... 4.99 ea.



1970-73 License Plate Lens

Correct license plate lamp with gasket.

LPL-860 1970-73.....18.95 ea.
 LPL-7G Gasket Only.....4.99 pr.

Note: Two required per car.



1970-73 License Lamp Assembly

Correct cadmium plated assemblies.

MEH-703 1970-73..... 49.99 pr.



1974-77 License Plate Lens

Correct license plate lamp with gasket.

LPL-768 1974-7722.95 ea.



BULB-67FI



Interior Bulb Kits

Vehicle specific kits include the following bulbs conveniently bagged & labeled.

1967-68

BULB-67FI 1967-6819.95 kit

- (6) Instrument Cluster, (2) Turn Signal Indicator, (1) Oil Pressure Indicator, (1) Headlamp Motor Warning, (1) Temp Indicator, (1) Alternator Indicator, (2) Courtesy Light, (1) Radio, (1) Heater / A/C Control, (1) High Beam Indicator, (1) Parking Brake Indicator, (1) Console Lamp, (1) Glovebox Compartment, (1) Underhood Lamp, (1) Dome Lamp

1969

BULB-69FI 196923.95 kit

- (5) Instrument Cluster, (2) Turn Signal Indicator, (1) Oil Pressure Indicator, (1) Temp Indicator, (1) Clock, (1) Alternator Indicator, (1) Map Light, (2) Courtesy Light, (1) Radio, (1) Heater / A/C Control, (1) High Beam Indicator, (1) Parking Brake Indicator, (1) Console Lamp, (1) Glovebox Compartment, (1) Underhood Lamp, (1) Trunk Lamp, (1) Dome Lamp

1970

BULB-70FI 197019.95 kit

- (3) Instrument Cluster, (2) Turn Signal Indicator, (1) Oil Pressure Indicator, (1) Temp Indicator, (1) Alternator Indicator, (1) Gearshift Indicator, (1) Radio, (1) Radio w/ Tape Player, (1) Heater / A/C Control, (1) High Beam Indicator, (1) Parking Brake Indicator, (1) Windshield Washer Indicator, (1) Console Lamp, (1) Glovebox Lamp, (1) Underhood Lamp, (1) Trunk Lamp, (1) Dome Lamp

1971-73

BULB-71FI 1971-7323.95 kit

- (3) Instrument Cluster, (2) Turn Signal Indicator, (1) Oil Pressure Indicator, (1) Temp Indicator, (1) Map Light, (2) Gearshift Indicator, (1) Radio w/ Tape Player, (1) Heater w/ A/C Control, (1) High Beam Indicator, (1) Windshield Washer Indicator, (1) Console Lamp, (1) Glovebox Compartment, (1) Underhood Lamp, (1) Trunk Lamp, (1) Dome Lamp



IHQ-0117



ICE-0351

Dome Light Lens Bezel

New plastic molded chrome plated as original.

IHQ-0117 1967-69 Coupe 9.99 ea.
ICE-0351 1970-81 Coupe 11.95 ea.



ICE-2777



INQ-0203

Dome Light Lenses

Correct white plastic lenses.

INQ-0203 1967-69 Coupe 3.99 ea.
ICE-2777 1970-81 Coupe 5.95 ea.
ICE-2789 1982-92 Coupe 9.99 ea.



AMH-15

Underhood Lamp

Complete with bracket, hardware, harness and built-in switch.

AMH-15 All39.99 kit



LPL-935

LPL-935

1982-92 License Plate Lamp Lens

The correct lens for the license plate lamp assembly.

1982-86 Berlinetta, 1982-84 Sport Coupe and Z/28, 1985-90 All models except Z/28

LPL-935 LH 21.99 ea.
LPL-935 RH 21.99 ea.

1985-90 Z/28, 1991-92 All

LPL-015 LH 23.99 ea.
LPL-016 RH 23.99 ea.



License Plate Socket

Correct socket for license plate bulb.

GPS-558 1967-69 All 4.95 ea.



LED License Plate Bulbs

A simple direct replacement for your side marker or license plate light bulb. This WHITE LED bulb features 5 dual super bright LEDs in a 194 bulb package. Excellent to increase brightness and reduce heat and power consumption

DT-200016 194 White LED Bulbs 16.95 pr.

Note: Also can be used for side marker or dash.



I-2194A

1967 Quarter Dome Lamp Kit

Complete quarter dome light kit for 1967 deluxe interior including lenses, bezels, sockets and bulbs for a complete replacement.

I-2194A 1967 w/ Deluxe Interior49.95 kit



IHQ-0117K

Dome Lamp Kit

Complete kit with new plastic molded and chrome plated dome light lens bezel, lens, bulb, terminals and harness extension.

IHQ-0117K 1967-69 All39.95 kit
ICE-0351K 1970-81 All39.95 kit



LED Accent Strips

These LED accent strips can be used for highlighting or mood lighting. Using strong double-sided tape, these can be mounted inside your car or under the hood.

LED-12-RED 12" Strip 20.99 ea.
LED-12-BLUE 12" Strip 20.99 ea.



BUY'N SAVE
WITH KITS

THIS IS AN
EXCLUSIVE
GROUND UP PRODUCT

Complete Lock Sets

Our lock kits come complete with ignition and doors keyed alike and glove box and trunk keyed alike just as original. We also include all necessary hardware for a complete job.

LCK-67F	1967 All	51.98 kit
LCK-67FR	1967 w/ Repro Tail Panel*	55.98 kit
LCK-68F	1968 All	61.58 kit
LCK-69F	1969 All	50.38 kit
LCK-70F	1970-73 All	63.98 kit

*If the rear panel on your 1967 was ever replaced with GM part #7710985 or a reproduction, use this kit.



LG-67-OE

Glove Box Lock Sets

Brand new glove box lock sets.

LG-67-OE	1967-68 Pear Keys w/ Knock Out	21.99 kit
LG-67SK	1967-68 Round Keys w/ Knock Out	18.99 kit
LG-69-OE	1969 Round Keys w/ Knock Out	15.99 kit
LG-70-OE	1970-81 Round Keys w/ Knock Out	15.99 kit
LGC-6881	1969-81 Lock Casing Only	9.99 kit



LI-68-OE



LI-83-OE

Ignition Lock Sets

Brand new ignition lock sets. Comes with extra key.

LI-67OE	1967 OE Octagon w/ Knockout	14.99 kit
LI-67SK	1967 Square Keys w/ Knock Out	11.99 kit
LI-68-OE	1968 Pear Keys w/ Knock Out	18.99 kit
LI-68SK	1968 Square Keys	14.99 kit
LI-69-OE	1969-78 Square Keys	14.99 kit
LI-69-OEKO	1969-78 Square Keys w/ Knock Out	26.99 kit
LI-79-OE	1979-89 Square Keys	14.99 kit
LI-83-OE	1983-88 Square Keys w/ Knock Out	18.99 kit



LID-69F

Ignition & Door Locks

Brand new lock cylinders and "keyed" alike keys complete with correct attaching clips and gaskets.

LID-67F	1967 All	29.99 kit
LID-67SK	1967 Square Key	21.99 kit
LID-67X	1967 Replacement Style Square Key	19.99 kit
LID-68F	1968 All	36.99 kit
LID-68SK	1968 Square Key	29.99 kit
LID-69F	1969- early 1970*	29.99 kit
LID-70F	1970-78 All	29.99 kit
LID-79F	1979-81 All	34.99 kit
LID-83F	1983-84 Round Keys w/ Black Ign	36.99 kit
LID-85F	1985-88 Round Keys w/ Black Ign	49.99 kit

*w/ short cylinder



LCK-67IDGT-RP

Ignition, Door, Glove Box & Trunk Lock Sets

Brand new ignition, door, glove box and trunk lock cylinders keyed alike.

LCK-X667IDGT	1967 Octagon Keys w/ Knock Out	59.99 kit
LCK-67IDGT-RP	1967* Octagon Keys w/ Knock Out	59.99 kit
LCK-68IDGTX	1968 Octagon Keys w/ Knock Out	59.99 kit
LCK-69IDGTX	1969 Square Keys	59.99 kit

*With horizontal trunk lock.



LD-70-OE

Door Lock Sets

Brand new door lock sets.

LDL-X62A	1967-69 Octagon Key	16.99 kit
LDL-X62RK	1967-69 Round Key	16.99 kit
LDL-X62SK	1967-69 Square Key	17.99 kit
LD-70-OE	1970-78 Round Keys	19.99 kit
LD-79-OE	1979-81 Round Keys	18.99 kit
LD-86BC	1986-92 Round Keys w/ Black Cap	18.99 kit
LD-93SK	1993-01 Round Keys w/ Black Cap	29.99 kit



LDGT-68

Door, Glove Box, & Trunk Lock Sets

Brand new door, glove box and trunk lock cylinders keyed alike.

LDGT-68	1968 Round Keys	39.99 kit
LDGT-68-OE	1968 Pear Keys w/ Knock Out	39.99 kit
LDGT-69-OE	1969 Round Keys	39.99 kit
LDGT-78	1978 Round Keys w/ Knock Out	54.99 kit



LDT-689

Door & Trunk Lock Sets

Brand new door and trunk lock cylinders keyed alike.

LDT-X62	1967 Pearhead Key w/ Knock Out	26.99 kit
LDT-X69	1967 Round Key w/ Knock Out	23.99 kit
LDT-689	1968-69 Round Key	23.99 kit
LDT-678-OE	1968 Pear Keys w/ Knock Out	32.99 kit
LDT-70-LS	1970-73 Round Key	39.99 kit
LDT-70-SS	1970-73 Round Key Long Cylinder	39.99 kit
LDT-74	1974-77 Round Key	44.99 kit
LDT-78	1978 Round Key	39.99 kit
LDT-79	1979-81 Round Key	39.99 kit
LDT-70B	1970-73 Round Key Black Bezels	54.99 kit
LDT-74B	1974-77 Round Key Black Bezels	44.99 kit
LDT-79B	1979-81 Round Key Black Bezels	49.99 kit
LDT-86	1986-92 Round Key	36.99 kit
LDT-93	1993-01 Round Key	49.99 kit



Door Lock Pawls

Correct bracket that attaches to the end tip of the door lock cylinder. The pawl trips the inner door latch assembly to open the door.

LP-1100	1967-78 RH Short Cylinder	5.95 ea.
LP-1101	1967-78 LH Short Cylinder	5.95 ea.
LP-1102	1970-78 RH Long Cylinder	5.95 ea.
LP-1103	1970-78 LH Long Cylinder	5.95 ea.
LP-1104	1979-81 RH	5.95 ea.
LP-1105	1979-81 LH	5.95 ea.
LPC-7	1967-81 All Door Lock Pawl Clip	1.99 pr.



Door Lock Knobs & Ferrules

OE style reproduction door lock knobs & ferrules.

ICF-4411	1967 Chrome Knob	5.99 ea.
IFF-401	1967 Ferrule	6.99 pr.
ICE-6400	1968-81 Chrome Knob	2.95 ea.
IFF-600	1968-69 All Ferrule	1.95 ea.
IFF-700	1968-81 All Ferrule	1.95 ea.



Door Opening Rod Assembly

Complete door opening rod assembly with plated rod, anti-rattle sleeve, center guide and end clip.

RDR-67FL	1967 All LH	15.99 ea.
RDR-67FR	1967 All RH	15.99 ea.
RDR-68F	1968-69 LH & RH	16.99 ea.
RLR-070L	1970-81 LH	18.99 ea.
RLR-070R	1970-81 RH	18.99 ea.



Inner Door Lock Rod

Plated inner door lock rod with threaded end for inner lock knob. Inner end of rod attaches to door latch mechanism actuator arm with clip (sold separately).

RLR-068	1967 All LH & RH	8.99 ea.
RLR-069	1968 All LH & RH	8.99 ea.



Door Opening Rod End Clips

Spring steel retaining clips attach the door opening rod to the door opening mechanism and the inner door lock rod end to the latch mechanism.

REC-070B	1967-69 All	4.99 pr.
----------	-------------------	----------



Inner Door Lock Rod & Bellcrank

Plated and threaded inner door lock rod with attached bellcrank.

RLR-066	1969 All LH & RH	10.99 ea.
RLR-062	1970-81 All LH & RH	16.99 ea.



Bellcrank Retainer

Two required to mount one bellcrank to door frame. 2 per door.

RBR-067	1969 All	5.99 ea.
---------	----------------	----------



Door Rod Insulators

This is a set of two correct door lock rod insulator shields which protect the long door opening rods in the doors.

RRI-11360	1967-69	7.95 set
-----------	---------------	----------



Door Handle Rod

Plated reproduction needed to connect outer door handle to door opening mechanism. Fits RH or LH door.

RRH-074	1970-81 All	6.99 ea.
---------	-------------------	----------



RDL-70FL

Door Latch Assemblies



OE style reproduction door latch assemblies.

RDL-67FL	1967 All LH	69.95 ea.
RDL-67FR	1967 All RH	69.95 ea.
RDL-67FK	1967 All LH/RH	111.92 kit
RDL-68FL	1968 All LH	69.95 ea.
RDL-68FR	1968 All RH	69.95 ea.
RDL-68FK	1968 All LH/RH	111.92 kit
RDL-69FL	1969 All LH	69.95 ea.
RDL-69FR	1969 All RH	69.95 ea.
RDL-69FK	1969 All LH/RH	111.92 kit
RDL-70FL	1970-81 All LH	69.95 ea.
RDL-70FR	1970-81 All RH	69.95 ea.
RDL-70FK	1970-81 All LH/RH	111.92 pr.
RDL-SCREW	1967-81 All (Set of 3)*	6.95 set
RDL-828L	1982-87 LH	79.99 ea.
RDL-828R	1982-87 RH	79.99 ea.

*Note: Does one door.



LTL-67K-OE

Trunk Lock Sets

Brand new trunk lock sets. Comes with extra key.

LT-67B-RD	1967-69 Round Keys	14.99 kit
LTL-67K-OE	1967-68 Pear Keys w/ Knock Out	15.99 kit
LT-67-OE	1967-69 Pear Keys w/ Knock Out	15.99 kit
LT-67RD	1967-69 Round Keys	14.99 kit
LT-70-OE	1970-73 Round Keys	29.99 kit
LT-74-OE	1974-77 Round Keys w/ Knock Out	19.99 kit
LT-78-OE	1978-81 Round Keys w/ Knock Out	21.99 kit
LT-86-OE	1986-92 Round Keys w/ Knock Out	15.99 kit
LT-93-OE	1993-01 Round Keys w/ Knock Out	18.99 kit



Trunk Lock Bezel & Gasket

OE style reproduction chrome lock bezel and gasket.

LLB-628	1970-73 Bezel	32.99 ea.
LLG-946	1970-73 Gasket	14.99 ea.



Trunk Lock Rods

Correct rod/shaft that connects the cylinder to the lock assembly.

TLR-458	1967-77 All	3.99 ea.
---------	-------------------	----------



Door/Trunk Lock Bracket

Correct bracket for retaining lock cylinder in place.

LTB-90	1967-81 All	2.99 ea.
--------	-------------------	----------



Trunk Lock Retainer

OE style reproduction of this hard to find bracket.

LTR-1	1967-68 All	18.99 ea.
LTR-3	1969 All	18.99 ea.



RTL-1019

RTL-7081

Trunk Lid Latch

Correct locking latch which installs inside the trunk lid.

RTL-1019	1967-69 All	29.95 ea.
RTL-7081	1970-81 All	29.95 ea.



TG-3902 TG-626 TG-384



TO-125

Standard Grille Emblems

High quality replacement grille emblems for your standard Camaro.

TG-3902	1967	39.99 ea.
TG-626	1968	29.95 ea.
TQ-125	1969	32.95 ea.
TG-6840	1974	59.95 ea.
TQ-384	1980-81	49.99 ea.



TC-6715 TQ-249 TQ-6870 TQ-6873

RS Grille Emblems

High quality replacement grille emblems for your Rally Sport Camaro.

TC-6715	1967-68	23.95 ea.
TT-599	1968 RS/SS SS396	25.99 ea.
TQ-249	1969	26.95 ea.
TK-6870	1980-81 RS Silver & Red	32.99 ea.
TK-6873	1980-81 RS Gold & Red	31.99 ea.



5th Gen Camaro Emblems

These peel & stick factory GM emblems can be applied to any vintage muscle car for a powerful modern look.

T-12SSW	SS White	29.95 ea.
T-12SSR	SS Red	29.95 ea.
T-ZL1	ZL1	49.95 ea.



TK-8004 TK-8002 TK-6767

SS Grille Emblems

High quality replacement grille emblems for your Super Sport Camaro.

TK-8003	1967-68 All RS/SS Grille	24.95 ea.
TK-8002	1967 SS350	26.99 ea.
TT-599	1967 SS396 RS/SS All	25.99 ea.
TG-015	1968 SS	26.99 ea.
TG-921	1969-71 SS	29.99 ea.
TQ-149	1969 SS w/ RS Grille	26.99 ea.
TG-015	1968 & 72 SS	26.99 ea.
TK-6717	"SS427" 1967 Std, 1967-68 RS	70.95 ea.
TK-6743	"SS427" 1968 Std	74.95 ea.
TT-6742	"SS396" 1968 Std	70.95 ea.
TT-6766	"SS396" 1969 Std	69.95 ea.
TK-6767	"SS427" 1969 Std	69.95 ea.
TK-6769	"SS427" 1969 RS	69.95 ea.



TQ-359

TQ-357



TQ-361



TC-6820 TC-7173 THP-6843 THP-6844

Header Panel Emblems

High quality replacement header panel emblems.

TQ-359	1967 Chevrolet Script	14.99 ea.
TQ-357	1967 Camaro	12.99 ea.
TQ-361	1968-69 Camaro	16.99 ea.
TC-6820	1970 C Script	29.99 ea.
TC-7173	1971-73 C Script	49.95 ea.
THP-6843	1975-77 Red, White, Blue	58.95 ea.
THP-6844	1975-77 Orange, Black, Red	58.95 ea.



TG-567

TG-496

Hood Emblems

TG-567	1969 Cowl Induction	32.95 kit
TG-496	1969 302	14.99 ea.



TK-8001

Z/28 Grille Emblems

High quality replacement grille emblems for your Z/28 Camaro.

TK-8001	1969 Z/28	34.99 ea.
TK-239	1970-71 Z/28	39.95 ea.
TK-6823	1972-73 Z/28	39.95 ea.



TK-78BL



TK-78GLD



TK-78GR



TK-78OR

1978 Z/28 Grille Emblem

Correct GM licensed reproduction of the hard to find 1978 only Z/28 grille emblem. Includes factory style brace plate and fasteners.

TK-78BL	1978 Blue	69.95 ea.
TK-78GLD	1978 Gold	69.95 ea.
TK-78GR	1978 Green	69.95 ea.
TK-78OR	1978 Orange	69.95 ea.
TK-78YL	1978 Yellow	69.95 ea.



TK-6880

1980-81 Z/28 Grille Emblems

Authentic emblem made of a black ABS back plate and clear UV stabilized acrylic front plate that is back painted the original tri-colors.

TK-6880	1980-81 Silver	52.95 ea.
TK-6881	1980-81 Charcoal	52.95 ea.
TK-6882	1980-81 Blue	52.95 ea.
TK-6883	1980-81 Green	52.95 ea.
TK-6884	1980-81 Gold	52.95 ea.
TK-6885	1980-81 Red	52.95 ea.
TK-6886	1980-81 Orange	52.95 ea.



TR-78LT

1978 Type LT Grille Emblem

Features correct script and colors as original and replaces GM number 468595.

TR-78LT	1978 LT	59.95 ea.
---------	---------	-----------



TG-834 TG-058



TT-1430



TQ-246



TQ-247



TD-488



TQ-410



TQ-355



TQ-356



TQ-409



TQ-427



TG-6831

Fender Engine Emblems

TG-834	1967 327.....	12.99 ea.
TG-058	1967 350.....	12.99 ea.
TT-1430	1967 396 Turbo Jet.....	29.95 pr.
TT-427	1967 427 Turbo Jet.....	32.95 ea.
TQ-246	1968 327.....	28.99 pr.
TQ-247	1968 350.....	28.99 pr.
TD-488	1968 396.....	29.99 pr.
TQ-410	1969 307.....	14.99 ea.
TQ-355	1969 327.....	28.99 pr.
TQ-356	1969 350.....	28.99 pr.
TQ-409	1969 396.....	28.99 pr.
TQ-427	1969 427.....	21.99 ea.
TG-6831	1970-75 350.....	21.99 ea.
TG-6830	1970-72 396.....	39.95 pr.



TQ-358



TG-318



TQ-190



TG-718



TQ-362



TQ-360



TQ-251

Fender Model Emblems

OE style reproduction fender model emblems which designate standard, SS, RS or Z/28.

TQ-358	1967 All Camaro.....	14.99 ea.
TG-318	1967 V Flags.....	14.99 ea.
TQ-190	1967 RS.....	12.95 ea.
TG-718	1967 SS.....	12.99 pr.
TQ-362	1968-69 Camaro Script.....	15.99 ea.
TQ-360	1968 Rally Sport.....	16.99 ea.
TQ-251	1968 SS.....	29.99 pr.
TG-045	1968 Z/28.....	32.99 ea.
TG-633	1969 Rally Sport.....	36.99 ea.
TQ-69SS	1969-72 SS (one side).....	17.99 pr.
TQ-69SSB	1969 SS Black.....	47.95 pr.
TQ-69SSR	1969 SS Red.....	47.95 pr.
TG-935	1969 Z/28.....	34.99 ea.
TG-310	1970-74 Camaro.....	25.99 ea.
TG-852	1970-73 Rally Sport.....	24.99 ea.
TG-956	1970-74 Z/28 Peel N Stick.....	40.99 ea.
TG-956-PIN	1970-74 w/ Mounting Pins.....	36.99 ea.
TG-798	1975-77 Camaro.....	25.95 ea.
TG-580	1978-81 Camaro.....	34.99 ea.
TQ-773-PS	Universal Chrome Peel N Stick.....	19.99 pr.



TG-045



TG-633



TG-935



TG-310



TG-852



TG-956



TG-798



TG-580



TQ-69SS



TQ-69SSB



TQ-69SSR



TQ-359 TQ-361
TQ-357 TG-701

Trunk Lid Emblems

OE style reproduction emblems for your trunk lid.

TQ-359	1967 Chevrolet Script.....	14.99 ea.
TQ-357	1967 Camaro.....	12.99 ea.
TQ-361	1968-69 Camaro.....	16.99 ea.
TQ-361A	1970 Camaro.....	29.99 ea.
TG-701	1971-73 Camaro.....	39.99 ea.
TTE-6838	1975-77 Red, White, Blue.....	59.95 ea.
TTE-6839	1975-77 Orange, Black, Red.....	58.95 ea.



TQ-69B TQ-250



TQ-393 TC-6725



TG-333 TR-74LT

Rear Panel Emblems

OE style reproduction emblems for your rear panel.

TQ-69B	1969 Bowtie.....	29.95 ea.
TQ-250	1969 RS.....	27.99 ea.
TQ-393	1969 SS.....	23.95 ea.
TC-6725	1969 SS396.....	72.95 ea.
TG-333	1969 Z/28.....	38.99 ea.
TC-6726	1969 SS427.....	72.95 ea.
TR-74LT	1974 LT.....	39.95 ea.



1974-76 Type LT Roof / Rear Panel Emblem

Features correct 1695874 casting number on back.

TR-LT-RP	1974-76 Type LT.....	38.95 ea.
----------	----------------------	-----------



1970-73 Spoiler Emblem

OE style reproduction Z/28 spoiler emblem.

TG-889	1970-73 Z/28.....	36.99 ea.
HZ-28	1970-73 Z/28 Decal.....	9.99 ea.



Fuel Door Emblems

OE style reproduction fuel door emblems featuring correct colors.

TF-455	1978-79 All.....	53.99 ea.
TF-557	1980-81 Berlinetta.....	53.99 ea.
TF-456	1980-81 w/o Berlinetta.....	55.99 ea.



1978 Z/28 Fuel Door Emblems

Correct GM licensed reproduction of the hard to find 1978 only Z/28 fuel door emblem.

TF-78BL	1978 Blue.....	49.95 ea.
TF-78GLD	1978 Gold.....	49.95 ea.
TF-78GR	1978 Green.....	49.95 ea.
TF-78OR	1978 Orange.....	49.95 ea.



1980-81 Z/28 Fuel Door Emblems

OE style reproduction of the original Z/28 fuel door emblems in the correct colors.

TF-803	Silver.....	59.99 ea.
TF-804	Charcoal.....	59.99 ea.
TF-805	Blue.....	59.99 ea.
TF-806	Green.....	59.99 ea.
TF-807	Gold.....	62.99 ea.
TF-808	Red.....	60.99 ea.
TF-809	Orange.....	62.99 ea.



Dick Harrell Emblem

This universal Diecast emblem is perfect for custom projects.

DH1018	All.....	59.99 ea.
--------	----------	-----------



Yenko Emblems

Correct Yenko and 427 emblems which are perfect for an original or recreation.

TK-8013	Yenko OE White.....	32.95 ea.
TK-8013-C	Yenko Chrome.....	44.95 ea.
TK-678	427.....	29.99 ea.



Universal Cross Flag Emblems

These universal cross flag emblems can be mounted anywhere on your car for a nice custom touch while still looking vintage. Universal. Measures 2-7/8" x 4-1/2" with 3 pins on back.

TG-454	454.....	39.95 ea.
TG-502	502.....	49.95 ea.
TG-572	572.....	36.95 ea.



427 Super Car Emblem

This emblem (GM number 3901932) was originally used on 1967 427 Impalas but it was also used by super car dealers on a lot of their conversions on fenders, hoods and trunk lids. Baldwin Motion used these emblems on the fenders of their super cars.

TK-427	All.....	16.95 ea.
--------	----------	-----------



Baldwin Motion SS427 Emblem

This emblem (GM number 7752254) was originally used on the deck lid of 1968 427 Impalas but it was also used by super car dealers on a lot of their conversions on fenders, hoods and trunk lids. Baldwin Motion often used these emblems on the valve covers of their super cars.

TK-SS427	All.....	64.95 ea.
----------	----------	-----------



Motion Emblem

This universal Baldwin Motion die-cast emblem is perfect for custom projects.

TK-MOTION	All.....	65.95 ea.
-----------	----------	-----------



1967-69 Z/28 Stripes

Stencil kits includes front and rear stencils with (1) 9/32"x 37.5' roll of stripe masking, squeegee and instructions. Stripe kit includes front and rear vinyl stripes w/ squeegee & instructions.

Stencil Kits

MSS-0687	1967-6869.99 kit
MSS-0688	196964.95 kit

Stripe Kits w/o Cowl Induction

MSS-0687W	1967-68 White129.95 kit
MSS-0687B	1967-68 Black129.95 kit
MSS-0687MB	1967-68 Matte Black134.95 kit
MSS-69ZW	1969 White139.95 kit
MSS-69ZB	1969 Black139.95 kit
MSS-69ZMB	1969 Matte Black134.95 kit
MSS-69ZO	1969 Orange139.95 kit

Stripe Kits w/ Cowl Induction

MSS-69ZWC	1969 White139.95 kit
MSS-69ZBC	1969 Black139.95 kit
MSS-69ZMBC	1969 Matte Black134.95 kit
MSS-69ZOC	1969 Orange139.95 kit

Note: For 1967-68 with spoiler, use 1969 kit.



1970-73 Z/28 Stripes

This kit contains everything you need to paint Z/28 stripes on your 1970-73 Camaro! Kit includes: (2) front header panel stencils, (2) front upper hood stencils, (2) rear deck lid and spoiler stencils, (1) 9/32" x 50' roll of stripe masking, squeegee and instructions.

MSS-0008	1970 Low Spoiler64.95 kit
MSS-0011	1970 Low Spoiler RS64.95 kit
MSS-0009	1970-72 High Spoiler64.95 kit
MSS-0010	1970-72 High Spoiler RS64.95 kit
MSS-0008	1973 High Spoiler64.95 kit
MSS-0011	1973 High Spoiler RS64.95 kit



1974 Z/28 Stripes

Includes (1) hood decal, (1) rear deck panel decal, (1) rear spoiler decal, squeegee and instructions.

MSS-1974Z	1974 Z/28289.95 kit
-----------	-----------	-----------------



1975-77 Rally Sport Stripes

Includes (2) Rally Sport fender names, (1) Rally Sport spoiler name, (2) fender stripes, (2) door stripes, (1) oval roof stripe, (3) rear spoiler stripes, squeegee and instructions.

MSS-75RSR	Dark Gray/ Medium Gray/Light Gray219.95 kit
MSS-75RSO	Red/Orange/Light Orange219.95 kit
MSS-75RSY	Orange/Yellow-Orange/Yellow219.95 kit
MSS-75RSR	Dark Red/ Medium Red/Light Red219.95 kit
MSS-75RSB1	Dark Blue/ Medium Blue/Light Blue219.95 kit
MSS-75RSB2	Dark Blue/ Medium Blue/Light Blue219.95 kit
MSS-75RSS	Dark Silver/ Medium Silver/Light Silver219.95 kit

MSS-75RSB1 is for 1975-76. MSS-75RSB2 is for 1977.



1977 Z/28 Stripes

Includes (1) hood decal, (2) front valance panel stripes, (2) front fender stripes, (2) door stripes, (2) rear quarter panel stripes, (3) rear spoiler stripes, (2) rear end panel stripes, squeegee and instructions.

MSS-77ZG	Brown/Gold269.95 kit
<i>(For black brown orange and white cars.)</i>		
MSS-77ZR	Red/Orange269.95 kit
<i>(With hollow names for silver and white cars.)</i>		
MSS-77ZR2	Red/Orange269.95 kit
<i>(With solid names for black and red cars.)</i>		
MSS-77ZY	Orange/Yellow269.95 kit
<i>(For yellow cars.)</i>		



1978-79 RS Stripes

Includes (2) Rally Sport Camaro fender names, (1) Rally Sport spoiler name, (1) front bumper stripe (1979), (2) front fender stripes, (2) door stripes, (1) oval roof stripe, (3) rear spoiler stripes, squeegee and instructions.

MSS-7879RS-BROWN	Medium Brown/ Dark Brown/Apricot219.95 kit
MSS-7879RS-RED	Orange/Dark Red/Gold219.95 kit
MSS-7879RS-BLUE	Medium Blue/ Dark Blue/Silver219.95 kit
MSS-7879RS-YELLOW	Medium Yellow/ Dark Yellow/Light Yellow219.95 kit
MSS-7879RS-GREEN	Medium Green/ Dark Green/Light Green219.95 kit



1978 Z/28 Stripes

Includes (1) inner hood decal, (1) outer hood decal, (1) front valance panel stripe, (2) front fender extension stripes, (2) front fender stripes, (2) door stripes, (2) rear quarter panel stripes, (3) rear spoiler stripes, squeegee and instructions. Also included are (3) fender Z/28 names in hollow or solid lettering.

MSS-78ZG1	Dark Gold w/ Hollow Names269.95 kit
MSS-78ZG2	Dark Gold w/ Solid Names269.95 kit
MSS-78ZR1	Red/Orange w/ Hollow Names269.95 kit
MSS-78ZR2	Red/Orange w/ Solid Names269.95 kit
MSS-78ZB1	Dark Blue/Blue w/ Hollow Names269.95 kit
MSS-78ZB2	Dark Blue/Blue w/ Solid Names269.95 kit
MSS-78GZ1	Light Green/Green w/ Hollow Names269.95 kit
MSS-78GZ2	Light Green/Green w/ Solid Names269.95 kit
MSS-78ZY	Yellow269.95 kit



1979 Z/28 Stripes

Includes (2) large front door stripes, (2) front fender stripes, (2) front air deflector stripes, (1) front air dam stripe, (3) rear spoiler stripes, (1) inner hood decal, (1) outer hood decal, (1) front header panel Z/28 logo, squeegee and instructions.



MSS-79Z	Light Gold/Dark Gold269.95 kit
MSS-79ZB	Light Blue/Dark Blue269.95 kit
MSS-79ZG	Light Green/Dark Green269.95 kit
MSS-79ZO	Orange/Yellow Orange269.95 kit
MSS-79ZR	Red/Orange269.95 kit
MSS-79ZS	Silver/Charcoal269.95 kit



1980-81 Z/28 Stripes

Includes (2) large front door stripes, (2) front fender stripes, (2) front air deflector stripes, (1) front air dam stripe, (3) rear spoiler stripes, (1) large hood decal, (2) air induction decals, squeegee and instructions.

MSS-8081ZSLV	Light Silver/Medium Silver/ Charcoal269.95 kit
MSS-8081ZGLD	Light Gold/Medium Gold/ Dark Gold269.95 kit
MSS-8081ZRED	Light Red/Medium Red/ Dark Red269.95 kit
MSS-8081ZBLU	Light Blue/Medium Blue/ Dark Blue269.95 kit
MSS-8081ZORG	Light Orange/Dark Orange/ Red269.95 kit
MSS-8081ZGRN	Light Green/Medium Green/ Dark Green269.95 kit



1982-84 Z/28 Stripes

Includes: (2) hood blackout decals, (2) front bumper stripes, (2) front fender stripes, (2) door stripes, (2) rear quarter panel stripes, (2) rear bumper stripes, squeegee and instructions.

MSS-8284Z-GOLDA	1982 Gold.....	169.99 kit
MSS-8284Z-GOLDB	1983-84 Gold.....	169.99 kit
MSS-8284Z-SILVER	1982-84 Silver.....	169.99 kit
MSS-8284Z-CHARCOAL	1982-84 Charcoal.....	169.99 kit
MSS-8284Z-ORANGE	1982-84 Orange.....	169.99 kit
MSS-8284Z-MAROON	1982-84 Maroon.....	169.99 kit
MSS-8284Z-BLUE	1982 Blue.....	169.99 kit
MSS-8284Z-BLUEMETA	1982 Metallic Blue.....	169.99 kit
MSS-8284Z-BLUEMETB	1983-84 Metallic Blue.....	169.99 kit



1985-87 IROC Z Stripes

Includes all lower body side stripes for: front bumper, front fenders, doors, rear quarter panels and rear bumper, 2 IROC-Z door names, squeegee and instructions.

Kits w/ Rolled Decals

MSS-8587IZ-GOLD	1985-87 Gold.....	119.99 kit
MSS-8587IZ-SILVER	1985-87 Silver.....	119.99 kit
MSS-8587IZ-RED	1985-87 Red.....	119.99 kit

Pre-Molded Decals

MSS-8587IZP-GOLD	1985-87 Gold.....	199.99 kit
MSS-8587IZP-SILVER	1985-87 Silver.....	199.99 kit
MSS-8587IZP-RED	1985-87 Red.....	199.99 kit



1988-90 IROC Z Stripes

Includes: (2) front end stripes, (2) side body stripes, (2) rear end stripes, (2) IROC-Z door names, squeegee and instructions.

MSS-8890IZ-GOLD	1988-90 Gold.....	199.99 kit
MSS-8890IZ-SILVER	1988-90 Silver.....	199.99 kit
MSS-8890IZ-RED	1988-90 Red.....	199.99 kit
MSS-8890IZ-BLUE	1988-90 Blue.....	199.99 kit
MSS-8890IZ-YELLOW	1988-90 Yellow/Silver.....	199.99 kit



1991-92 Heritage

Includes: (2) front hood/cowl stripes, (2) rear luggage compartment stripes, (2) rear deck lid stripes, (2) rear spoiler stripes, squeegee and instructions.

RS Coupe

MSS-9192H-CPE-BLACK	1991-92 Black.....	219.99 kit
MSS-9192H-CPE-SILVER	1991-92 Silver.....	219.99 kit
MSS-9192H-CPE-RED	1991-92 Red.....	219.99 kit
MSS-9192H-CPE-GOLD	1991-92 Gold.....	219.99 kit

RS Convertible

MSS-9192H-CVT-BLACK	1991-92 Black.....	219.99 kit
MSS-9192H-CVT-SILVER	1991-92 Silver.....	219.99 kit
MSS-9192H-CVT-RED	1991-92 Red.....	219.99 kit
MSS-9192H-CVT-GOLD	1991-92 Gold.....	219.99 kit

Z/28 Coupe

MSS-9192H-Z28-BLACK	1991-92 Black.....	219.99 kit
MSS-9192H-Z28-SILVER	1991-92 Silver.....	219.99 kit
MSS-9192H-Z28-RED	1991-92 Red.....	219.99 kit
MSS-9192H-Z28-GOLD	1991-92 Gold.....	219.99 kit



1993-02 Z/28 & 1997 30th Anniversary Stripes

Includes: (2) front bumper stripes, (2) hood stripes (non SS), (2) roof stripes (coupe only), (2) rear luggage compartment stripes, (2) rear spoiler stripes, squeegee and instructions.

Coupe

MSS-9730TH-CPE-ORANGE	1993-97 Orange.....	219.99 kit
MSS-9730TH-CPE-BLACK	1993-97 Black.....	219.99 kit
MSS-9730TH-CPE-WHITE	1993-97 White.....	219.99 kit
MSS-9730TH-CPE-SILVER	1993-97 Silver.....	219.99 kit
MSS-9730TH-CPE-RED	1993-97 Red.....	219.99 kit

Convertible & T-Tops

MSS-9730TH-CTT-ORANGE	1993-97 Orange.....	219.99 kit
MSS-9730TH-CTT-BLACK	1993-97 Black.....	219.99 kit
MSS-9730TH-CTT-WHITE	1993-97 White.....	219.99 kit
MSS-9730TH-CTT-SILVER	1993-97 Silver.....	219.99 kit
MSS-9730TH-CTT-RED	1993-97 Red.....	219.99 kit

Coupe

MSS-9800C-CPE-ORANGE	1998-02 Orange.....	219.99 kit
MSS-9800C-CPE-BLACK	1998-02 Black.....	219.99 kit
MSS-9800C-CPE-WHITE	1998-02 White.....	219.99 kit
MSS-9800C-CPE-SILVER	1998-02 Silver.....	219.99 kit
MSS-9800C-CPE-RED	1998-02 Red.....	219.99 kit

Convertible & T-Tops

MSS-9800C-CTT-ORANGE	1998-02 Orange.....	219.99 kit
MSS-9800C-CTT-BLACK	1998-02 Black.....	219.99 kit
MSS-9800C-CTT-WHITE	1998-02 White.....	219.99 kit
MSS-9800C-CTT-SILVER	1998-02 Silver.....	219.99 kit
MSS-9800C-CTT-RED	1998-02 Red.....	219.99 kit



1998-02 35th Anniversary Stripes

Includes: (2) hood decals (L&R), (1) hood blackout decal, (1) front end fascia set upper, (1) front end fascia set lower, (2) rear spoiler stripes (L&R), (2) rear deck stripes (L&R), squeegee and instructions.

Coupe

MSS-0235TH-CPE-SILVER	1998-02 Silver.....	269.99 kit
MSS-0235TH-CPE-BLACK	1998-02 Black.....	269.99 kit

Convertible

MSS-0235TH-CVT-SILVER	1998-02 Silver.....	269.99 kit
MSS-0235TH-CVT-BLACK	1998-02 Black.....	269.99 kit



PREAPP

Pre-Application Surface Cleaner

Remove contaminants like silicones, wax, tree sap and bug guts for a clean and adherent surface.

PREAPP	4 oz. Pre-App Cleaner.....	13.95 ea.
--------	----------------------------	-----------



SOAG

SLIDE-ON Application Gel

Slide-On contains a special formula that resists drying until you are ready to squeegee the graphic into place. Only then does the decal "set up".

SOAG	16 oz. Application Gel.....	19.95 ea.
------	-----------------------------	-----------



SOPC

SLIDE-OVER UV Protectant

Help protect your decal from harsh elements and natural aging by applying our revolutionary Slide-Over UV Protectant & Conditioner.

SOPC	8 oz. UV Protectant.....	19.95 ea.
------	--------------------------	-----------



Air Cleaner Decals SB

HOJ-(Engine Horsepower)..... 4.99 ea.
Ex. HOJ-350250 for decal above.



Cross Flag Decals BB

HOJ-(Engine)..... 4.99 ea.
Ex. HOJ-396 for decal above.



Turbo Jet Decals BB

HOJ-(Horsepower)..... 4.99 ea.
Ex. HOJ-375 for decal above.



Air Cleaner Decal

HOJ-476 All w/o Cowl Ind 4.99 ea.
HOJ-259 All w/ Cowl Ind 4.99 ea.



HOJ-396-DC

Diecast Air Cleaner Decals

HOJ-(engine)-DC Diecast 69.99 ea.
Ex. HOJ-396-DC for the decal above.



HOJ-375-DC

Diecast Turbo Jet Decals

HOJ-(Horsepower)-DC Diecast 49.99 ea.
Ex. HOJ-375-DC for the decal above



A/C Compressor Decals

HOJ-741 1967-68 Green 5.99 ea.
HOJ-607 1969-72 Red 5.99 ea.
HOJ-271 1973-74 4.99 ea.



A/C Window Decals

HAC-67 1967 5.99 ea.



A/C Box Decals

HOJ-550 All Harrison 4.99 ea.



Brake Bail Decals for PB

HOJ-SR 1967 SR 3.95 ea.
HOJ-CH 1968 CH 3.95 ea.
HOJ-CU 1969 CU 3.50 ea.
HOJ-LB 1970 LB 3.95 ea.



Brake Check Valve Decal

HOJ-330 1967 SR 3.95 ea.
HOJ-YX 1967 YX 4.95 ea.
HOJ-331 1968 CH 4.95 ea.
HOJ-332 1969 CU 4.95 ea.



Caliper Backing Plate Decals

HCT-67 1967 CT 4.95 ea.
HCS-68 1968 CS 4.95 ea.
HAI-69 1969 Z/28 AI 4.95 ea.
HAD-69 1969 BB AD 4.95 pr.



Fan Caution Decal

HFA-930 All 6.99 ea.



Coil Spring Decals

HCS-YC 1967 327 or 350 YC 6.95 pr.
HCS-YY 1967 SS350 YY 6.95 pr.
HCS-YG 1967 SS396 YG 6.95 pr.
HCS-YW 1967 Z/28 YW 6.95 pr.
HCS-EG 1968 SS396 EG 6.95 pr.
HCS-EE 1968 Z/28 EE 6.95 pr.
HCS-YC 1968 327 or 350 YC 6.95 pr.
HCS-350 1968 SS350 YC 6.95 pr.
HCS-EK 1969 350 EK 6.95 pr.
HCS-EY 1969 Z/28 EY 6.95 pr.
HCS-YF 1969 Z/28 YF 6.95 pr.
HCS-YM 1969 Z/28 RS YM 6.95 pr.
HCS-HG 1969 ZL1 4spd HG 6.95 pr.
HCS-HQ 1969 396 or 427 HQ 6.95 pr.
HCS-YP 1969 396 or 427 YP 6.95 pr.
HCS-YH 1969 396 YH 6.95 pr.
HCS-EN 1970 Z/28 EN 6.95 pr.

The two letter suffix on each part number is the code that will appear on the decal.



Cooling System Decal

HOJ-144 1967-69 All 4.99 ea.
HOJ-242 1970-71 All 4.99 ea.



Emission Decals

HE-68H All 4.99 ea.
HE-U 1968 SB, 396/325 or 350 4.99 ea.
HE-P 1968 Z/28 4.99 ea.
HE-CH 1969 396/375 CH 4.99 ea.
HE-CN 1969 427/425 CN 4.99 ea.
HE-CG 1969 396/325-350 CG 4.99 ea.
HE-CF 1969 350 & Z/28 4.99 ea.
HE-CE 1969 307 or 327 4.99 ea.
HE-AX 1970 350/350 AX 4.99 ea.
HE-AT 1970 396/350 Auto AT 4.99 ea.
HE-AR 1970 396/350 Man AR 4.99 ea.

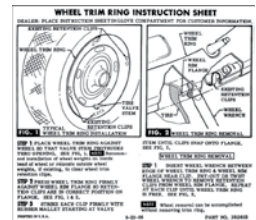

Rally Trim Ring Instructions

These instructions were found in the glove box of cars with rally wheels. They explain the installation and removal of the trim rings.

HTR-806 1967-74 4.99 ea.



Engine Starting Guide

Explains the procedure for starting your new Camaro. Details the new ignition locking steering columns.

HSS-69 1969 Z/28 All 10.95 ea.



Door Jamb Decals

HDJ-678 1967-68 Green 5.99 ea.
HDJ-69 1969 Blue 5.99 ea.

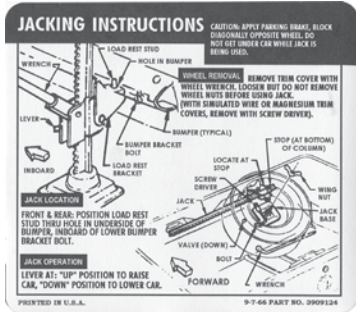

Jacking Instructions

HJC-830 1967-68 All 4.99 ea.
HJC-861 1969 non-SS 4.99 ea.
HJC-838 1969 SS 4.99 ea.
HJC-863 1970-73 All 4.99 ea.
HJC-866 1973 w/ Space Saver 4.99 ea.



Leaf Spring Decals

HLS-BY 1967 Z/28 BY 6.95 pr.
HLS-OH 1967 SS396 OH 6.95 pr.
HLS-OA 1968 Z/28 OA 6.95 pr.
HLS-BX 1968 327 or 350 BX 6.95 pr.
HLS-BH 1969 SS350 BH 6.95 pr.
HLS-BM 1969 350 or Z/28 BM 6.95 pr.
HLS-BK 1969 BB BK 6.95 pr.

The two letter suffix on each part number is the code that will appear on the decal.



Yenko Fan Shroud Decal

HY-164 1969 Yenko S/C 9.99 ea.



Oil Canister Decal

HOC-28 1967 5.99 ea.

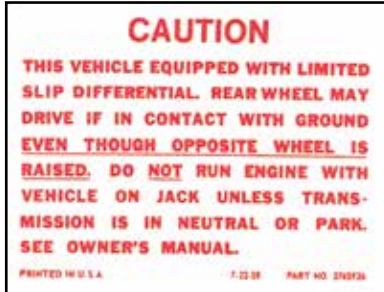

Positraction Decal

HBH-797 1967-81 Most 4.99 ea.



Shock Decals

HSF-PS 1969 Z/28 Front 7.95 pr.
HSR-UN 1969 Z/28 Rear 7.95 pr.
HSF-PW 1969 All BB Front 7.95 pr.
HSR-TN 1969 All BB Rear 7.95 pr.



Z/28 Spoiler Decal

HZ-28 1970-73 Z/28 9.99 ea.



Steering Box Decals

HSB-299 All w/ Power Steering 4.95 ea.



Yenko Window Decal

HY-069 1969 Yenko S/C 8.99 ea.



Tire Pressure Decals

HTP-182 1967 All 4.99 ea.
HTP-172 1968 All 4.99 ea.
HTP-190 1969 SS Code DW 4.99 ea.
HTP-170 1969-70 Code AO 4.99 ea.
HTP-406 1970-73 BP 5.99 ea.
HTP-407 1971-73 Z/28 4.99 ea.



Tonawanda Decal

ATO-3000 All BB 4.99 ea.



Flint Decal

HFT-50 1967 SB 4.99 ea.



Valve Cover Cross Flags Decal

HVC-28 1969-74 Z/28 8.95 ea.



Valve Cover Decals

HJL-69 1969 396/375 Auto 5.95 ea.
HJI-69 1969 396/350 Auto 5.95 ea.
HJH-69 1969 396/375 Manual 5.95 ea.
HJJ-69 1969 L89 396/375 5.95 ea.
HMO-69 1969 427/427 Auto 5.95 ea.
HMN-69 1969 427/427 Manual 5.95 ea.



Yenko Valve Cover Decal

HV-225 1969 Yenko S/C 11.99 ea.



Engine Paint

- VHT® High Temperature Engine Enamel; Nu-Cast Aluminum; 11 oz. Aerosol
 VHT-SP995 Nu-Cast Aluminum..... 7.99 ea.
 VHT® High Temperature Engine Enamel; Cast Iron; 11 oz. Aerosol
 VHT-SP997 Cast Iron..... 8.99 ea.
 VHT® High Temperature Engine Enamel; Chevy Orange; 11 oz. Aerosol
 VHT-SP123 Chevy Orange 7.99 ea.
 VHT® High Temperature Engine Enamel; Gloss Black; 11 oz. Aerosol
 VHT-SP124 Gloss Black..... 8.99 ea.
 VHT® High Temperature Engine Enamel; Flat Black; 11 oz. Aerosol
 VHT-SP130 Flat Black..... 7.99 ea.
 VHT® High Temperature Engine Enamel; GM Blue; 11 oz. Aerosol
 VHT-SP135 GM Blue 8.99 ea.
 VHT® High Temperature Engine Enamel; Motor-Brite Clear; 11 oz. Aerosol
 VHT-SP29 Motor-Brite Clear..... 8.99 ea.
 VHT® Wrinkle Plus; High Temp Wrinkle Finish; Black; 11 oz. Aerosol
 VHT-SP201 Black Wrinkle 12.99 ea.

Trunk Paint

- Dupli-Color® Spatter Paint; Black/Gray; 11 oz. Aerosol
 DUP-DM102 Black/Gray Spatter..... 8.99 ea.
 Dupli-Color® Spatter Paint; Gray/White; 11 oz. Aerosol
 DUP-DM100 Gray/White Spatter..... 8.99 ea.
 Dupli-Color® Spatter Paint; Black/Aqua; 11 oz. Aerosol
 DUP-DM109 Black/Aqua Spatter..... 8.99 ea.
 Dupli-Color® Premium Lacquer; Clear; 12 oz. Aerosol
 DUP-DAL1695 Clear Coat..... 9.99 ea.

Vinyl Paint

- VHT Vinyl Dye Gloss Jet Black; 11 oz. Aerosol
 VHT-SP941 Gloss Jet Black 8.99 ea.
 VHT Vinyl Dye White Satin; 11 oz. Aerosol
 VHT-SP943 White Satin 9.99 ea.

Primer

- Dupli-Color® Self-Etching Primer; Green; 12 oz. Aerosol
 DUP-DAP1690 Self-Etching Primer 10.99 ea.
 VHT® Prime Coat; Red Oxide; 12 oz. Aerosol
 VHT-SP303 Red Oxide Primer 7.99 ea.

Detailing Paint

- Dupli-Color® Premium Enamel; Machinery Gray; 12 oz. Aerosol. Ideal for GM shocks.
 DUP-DA1612 Machinery Gray..... 8.99 ea.
 Dupli-Color® Premium Lacquer; Flat Black; 12 oz. Aerosol
 DUP-DAL1607 Flat Black 8.99 ea.
 Dupli-Color® Premium Lacquer; Semi-Gloss Black; 12 oz. Aerosol
 DUP-DAL1608 Semi-Gloss Black 7.99 ea.
 Dupli-Color® Premium Lacquer; Gloss Black; 12 oz. Aerosol
 DUP-DAL1677 Gloss Black..... 8.99 ea.
 Dupli-Color® Premium Lacquer; Clear; 12 oz. Aerosol
 DUP-DAL1695 Clear 9.99 ea.
 Dupli-Color® Automotive Metallic Coating; Stainless Steel; 11 oz. Aerosol
 DUP-SS100 Stainless Steel..... 8.99 ea.
 Dupli-Color® Trim Paint; Black; 11 oz. Aerosol
 Formulated to restore an OEM Flat Black finish to metal trim and molding around windows, body sides and other vehicle areas.
 DUP-TP70 Black 9.99 ea.
 VHT® Plate Finish; Chrome; 11 oz. Aerosol
 VHT® Plate Finish™ is a unique quick drying formulation specifically created for application on metal, glass and wood or sealed plastic surfaces. This non-tarnishing epoxy finish has outstanding brilliance and corrosion resistance. VHT® Plate Finish™ is easy to use and dries in minutes. Excellent for touch-up, refinishing and decorative applications.
 VHT-SP5251 Chrome 8.99 ea.

Radiator Paint

- VHT-SP139 Radiator Black 7.99 ea.



Wheel & Tire Paint

- Dupli-Color® Hot Tires Tire Paint; White; 0.5 oz. Paint Pen.**
 Whether your tires are old or new, Dupli-Color® Hot Tires™ gives you a way to add color or personalize your muscle car, truck or sport compact tires. This fast-drying, durable coating allows you to touch-up faded white walls or tattoo your high performance tires. Hot Tires goes on smooth, resists fading and is available in an easy-to-use pen.
 DUP-HT100 White Tire Paint 10.99 ea.
Dupli-Color® Wheel Coating; Silver; 11 oz. Aerosol
 Argent silver for Chevrolet Rally Wheels.
 DUP-HWP101 Argent Silver 7.99 ea.
Details® 1969-70 SS Wheel Insert Gray Paint
 Correct gray for 1969-70 SS wheel inserts.
 HDP-1214 1969-70 SS Insert Gray 7.95 ea.
Dupli-Color® Wheel Coating; Graphite; 11 oz. Aerosol
 Dark gray for SS 5 spoke wheels.
 DUP-HWP102 1971-81 SS Gray 9.99 ea.

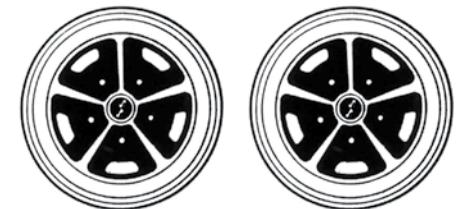

HMK-6970

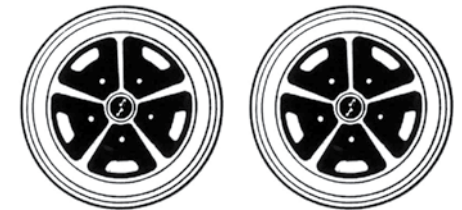

1969-70 SS Wheel Paint Mask Kit

Die stamped wheel mask kit for correctly painting your SS wheels.

- HMK-6970 1969-70 Wheel Mask 27.95 kit

Dupli-Color Rust Barrier

- DUP-RBQ101 Quart Gloss Black..... 29.99 ea.
 DUP-RBQ102 Quart Silver..... 29.99 ea.
 DUP-RBG101 Gallon Gloss Black 109.99 ea.
 DUP-RBG102 Gallon Silver 109.99 ea.

Dupli-Color Clear Bed/Trunk Coating

- DUP-CTBA100 Aerosol..... 16.99 ea.
 DUP-CTBQ100 Quart..... 28.99 ea.





Shop Manual Set

This set of factory manuals offers all of the information you need when you are restoring or servicing your car. Each manual is full of pictures and tutorials of everything from simple maintenance to complete removal and installation of virtually everything on the car. These are the same manuals that GM dealers used on most repair and warranty work.

HMS-67F	1967 All	71.04 kit
HMS-68F	1968 All	71.04 kit
HMS-69F	1969 All	71.04 kit
HMS-70F	1970 All	71.04 kit
HMS-71F	1971 All	71.04 kit
HMS-72F	1972 All	71.04 kit



Owner's Manual Bags

Correct factory plastic bag for your owners manual and dealer information.

HMB-2	1967-68 All	5.99 ea.
HMB-3	1969-72 All	5.99 ea.
HMB-4	1973-81 All	5.99 ea.



Factory Service Manuals

This manual was used by GM dealers to service your car when new. From simple maintenance to major component repair, this manual has all of the info needed to service your car.

HSM-67	1967 All	29.99 ea.
HSM-68	1968 All	29.99 ea.
HSM-69	1969 All	29.99 ea.
HSM-70	1970 All	29.99 ea.
HSM-70F	1970 Supplement	15.00 ea.
HSM-71	1971 All	29.99 ea.
HSM-72	1972 All	29.99 ea.
HSM-73	1973 All	57.99 ea.
HSM-74	1974 All	40.99 ea.

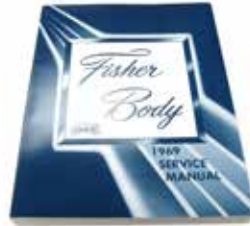

Fisher Body Manuals

Complete information on the actual body of the car including interior, trim, door panels, glass, trunk and more!

HFB-67	1967	26.95 ea.
HFB-68	1968	26.95 ea.
HFB-69	1969	26.95 ea.
HFB-70	1970	26.95 ea.
HFB-70F	1970 Supplement	26.95 ea.
HFB-71	1971	26.95 ea.
HFB-72	1972	26.95 ea.
HFB-73	1973	29.95 ea.



Assembly Manuals

A must for all restorations! These books were used at the factory plants as a reference guide for linemen. This book features all engineering drawings, GM numbers and torque specs.

HA-F67	1967 All	21.99 ea.
HA-F68	1968 All	21.99 ea.
HA-F69	1969 All	21.99 ea.
HA-F70	1970 All	21.99 ea.
HA-F71	1971 All	21.99 ea.
HA-F72	1972 All	21.99 ea.
HA-F73	1973 All	21.99 ea.
HA-F74	1974 All	21.99 ea.
HA-F75	1975 All	21.99 ea.
HA-F76	1976 All	21.99 ea.
HA-F77	1977 All	21.99 ea.
HA-F78	1978 All	21.99 ea.
HA-F79	1979 All	21.99 ea.
HA-F80	1980 All	21.99 ea.
HA-F81	1981 All	21.99 ea.



Chevy Start Sleeve

Authentic reproduction starting instruction sleeve which was installed on the sun visor.

HSS-69	1969-72	10.95 ea.
--------	---------	-----------



Blank Build Sheet

OE style reproduction of the factory build sheet which allows you to make your own custom paper, perfect for a recreation car!

HBS-66	1966-72 All	10.99 ea.
--------	-------------	-----------

Blank Window Stickers

OE style reproduction of the factory window sticker which allows you to make your own custom paper, perfect for a recreation car!

HOB-386	1967 All	7.99 ea.
HOB-879	1968-69 All	7.99 ea.
HOB-350	1970-72 All	7.99 ea.

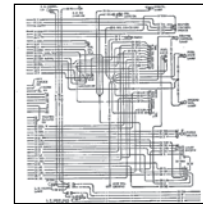

Wiring Diagrams

Original GM wiring schematic from bumper to bumper

HWD-67F	1967	9.99 ea.
HWD-68F	1968	9.99 ea.
HWD-69F	1969	9.99 ea.
HWD-RS	1967-69 RS	9.99 ea.
HWD-70F	1970	9.99 ea.
HWD-71F	1971	9.99 ea.
HWD-72F	1972	9.99 ea.
HWD-73F	1973	9.99 ea.



Convertible Top Manuals

Correct convertible top manuals.

HVT-7	1967 All	6.95 ea.
HVT-8	1968 All	6.95 ea.

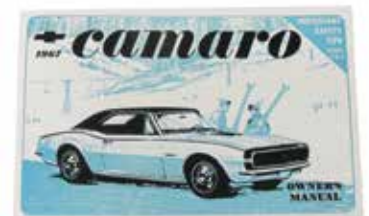

Factory Owner's Manual

Authentic reproductions of the original factory owners manuals which came with all cars.

HDG-__F	1967-81 All	15.99 ea.
---------	-------------	-----------

Insert your year in the blank.

Harness.....197
Instrument Cluster.....23
Knobs.....31-33
Lens.....23-24
Pad.....20-21
Panel.....23, 27-29, 180
Repair Panel.....180
Speaker.....55
Top Panel.....180
Trim.....30-31
Under Dash Hardware Kits.....118
Vents.....21-23
Dakota Digital.....27-29, 207
Decals.....217-221
Defogger.....21, 38
Demon Carburetion.....121
Detroit Speed
Deep Tubs.....183
Mini Tub Kit.....78
Selecta-speed Wiper Kit.....146
Subframe.....77
Suspension Kits.....75-78, 81-84
Tubular Control Arms...77-79, 81-84
Quadralink.....78
Differential Cover.....102
Digi-Tails
LED Parking Lamp.....207
LED Tail Light.....209
Disc Brakes
Conversion.....65-67
Components.....65-74
Distribution Block.....70
Dip Stick
Engine Oil.....130-131
Transmission.....104, 149
Distributor.....125, 203
Cap.....125, 203
Hold Down.....125, 150
Dome Light.....50-51, 211
Door
Door Jamb Switch.....200
Edge Guard.....161
Glass.....190-191
Glass Hardware.....190-191
Handle (Interior).....18-19
Handle (Exterior).....159
Handle Mechanism.....19
Hardware.....180-181
Hinge.....181
Hinge Bolts.....152, 181
Latch.....181
Ledge Molding.....160
Mounting Hardware.....180-181
Shell.....180
Skin.....180
Striker.....20, 152
Weatherstrip.....194-195
Door Panels.....13-16
Carpet.....19
Clips.....19
Emblems.....17
Grab Handle.....19
Moldings.....14
Plugs.....19
Retainer.....14-15
Trim Tools.....18

Washers.....19
Water Shield.....20
TMI.....16
Drain Plug
Oil.....131, 154
Radiator.....117
Rear End.....102
Drum Brakes.....73
Dust Shield (A-arm).....195

E

Eddie Motorsports
Door Handles.....159
Door Jamb Vents.....19
Door Strikers.....20, 152
Fender Braces.....149, 175-176
Hood Adjustment Bolts.....153
Hood Hinges.....178
Hood Latches.....178
Tail Lamp.....208
Trunk Hinges.....188
Emblems.....214-216
Templates.....217
Emergency Brake
Cables.....72
Pedal Assembly.....73
End Links (Sway Bar).....86
Engine
Decals.....220-221
Hardware Kits.....140, 150, 156
Harness.....198
Lifting Rings.....123
Mount.....142
Paint.....222
Exhaust.....108-112
Cut Out.....109, 111
French Locks.....108
Hangers.....109
Heat Riser Valve.....108
Headers.....109, 111-112
Manifolds.....108, 112
Manifold Bolts.....108, 152
Systems.....109-111
Tips.....109

F

Fan
Blower Motor.....118
Clutch.....115
Cooling.....114-115
Decal.....220
Electric Fan.....114-115
Shroud.....116
Fender.....174-175
Bolts.....153, 175
Brace.....149, 175-176
Brackets.....175
Extension.....175
Fender Grippers.....148
Inner Fender Wells.....175
Patch Panel.....175
Support Bars.....149, 175-176
Washer.....176
Welting.....161

Filter
Air Cleaner.....119-120
Fuel.....107, 138
Oil.....131
Fire Extinguisher.....41
Firewall.....180
A/C Delete.....118
Bracket.....180
Clip.....147
Cover.....118, 180
Fill Plate.....118
Heater Delete.....118
Insulation.....39, 44
Rod.....99
Flaming River Columns.....37
Flex Hoses.....74
Floor Mats.....42
Floor Pan.....184-185
Brace.....185
Drain Plug.....186
Full Floor.....184
Half.....184
Patch.....184-185
Shifter Hump.....186
Shifter Tunnel.....47, 95
Toe Board.....185
Trunk Floor.....186-187
Flowmaster.....110-112, 120
Cold Air Intake.....120
Exhaust.....110-112
Flowtech.....111-112
Flywheel.....98, 105
Bolts.....98
Inspection Cover.....98, 104
Fold Down Seat
Brackets.....12
Cover.....5
Components.....12
Partition.....12
Forward Lamp Harness.....198
Frame Marking Crayons.....147, 204
Frame Rails.....185
Frostbite Cooling.....113
Fuel
Filter.....107, 138
Hose.....138
Gauge.....24-25
Fuel Lines.....108, 137-138
Clips.....107, 137
Fuel Pump.....138
Hardware.....137
Pump to Carb Lines.....137
Fuel Tank.....106
Brace.....187
Cap.....107, 168
Door.....107, 168
Hardware.....106, 153
Filler Neck.....107
Sender Harness.....107, 198
Sending Unit.....107
Straps.....106

G

Gaskets
Air Cleaner.....121
Carburetor.....123

Heater Box.....118
Exhaust (Donut).....108
Exhaust (Heat Riser).....108
Oil Pan.....130
Paint Seal Kits.....196
Parking Lamp.....207
Rear End Cover.....102
Side Marker.....207
Tail Lamp.....208
Gauges.....24-29
GForce Crossmembers.....100
Glass.....190-193
Glass Hardware.....190-193
Glove Box.....31-32
Catch Plate.....32
Door.....31
Emblems.....32
Lamp.....32, 201
Lock.....212-213
Screws.....32
Grille.....162-164
Billet.....164
Hardware.....164
Grille Kits.....162
Molding.....164
Ground Strap Kits.....127, 203
GT Performance Steering.....35

H

Handle
Door Handle (Inside).....18-19
Door Handle (Outside).....159
Grab Handle.....19, 30
Shifter.....40, 47, 94-97
T-Top.....52
Vent Window.....191
Hardware.....150-156
Harness Retainer.....147
Harness Tape.....147
Hays Clutches.....105
Heat Stove.....108
Header
Headers.....109-112
Header Bow.....57
Header Panel.....179
Headlamps.....205
Bezel.....165
Bucket.....206
Dimmer Switch.....201
Door.....170
Hardware.....165
Housing.....206
Motor.....171
Mounting Panel.....165
Switch.....173, 201
Washer Nozzles.....173
Washer Pump Harness.....173
Headliner.....49
Bows.....49
Insulation.....49
PUI Headliners.....49
TMI Headliners.....49
Trim.....49, 50
Headrest.....12
Heater
Blower Motor.....118



Box.....	118	Instrument Cluster	Case.....	23	LED Lights	Accent Strips.....	211	Molding	Clips.....	157
Box Cover.....	118	Dakota Digital.....	27-28	Dash Bulb.....	26	Convertible Header.....	158	Convertible Pillar.....	159	
Control Assembly.....	38	Gauges.....	24-29	Dome Light Bulb.....	51	Convertible Well.....	158	Dash.....	21	
Control Cables.....	38	Lenses.....	23-24, 26	License Plate Bulb.....	211	Door Edge Guard.....	161	Door Ledge.....	160	
Control Lens.....	38	Panel.....	23	Parking Lamp Kit.....	206-207	Door Panel.....	14	Door Panel.....	14	
Delete Plate.....	118	Plate.....	24	Reverse Bulb.....	209	Drip Rail.....	158	Door Panel.....	14	
Heater Core.....	118	Insulation		Side Marker Bulb.....	207	Front Windshield.....	157	Door Panel.....	14	
Hoses.....	117	Headliner.....	49	Tail Light Kit.....	209	Grille.....	162-164	Door Panel.....	14	
Hedman LS Swap	142	Hood.....	149	Turn Signal Bulb.....	207	Optional (70-73).....	161	Door Panel.....	14	
Hinge		Kick Panel.....	39	Lens		Quarter Window.....	161	Door Panel.....	14	
Door.....	181	Intake Manifold		Console (Rear).....	48	Rear Window.....	157	Door Panel.....	14	
Glove Box.....	31	Bolt Kits.....	123	Dash (Instruments).....	23-24	Rocker Panel.....	160	Door Panel.....	14	
Hood.....	176	Stud.....	123	Dash (Indicators).....	26	Studs.....	157	Door Panel.....	14	
Spring.....	178, 181	Vacuum Fittings.....	123	Dome Light.....	50-51, 211	Vinyl Top.....	158	Door Panel.....	14	
Trunk.....	188	Interior		Heater Control.....	38	Wheel Opening.....	161	Door Panel.....	14	
Holley	121, 130, 138	Bulb Kits.....	51, 211	License Plate Lamp.....	210-211	Motor Mount	142	Door Panel.....	14	
Hood	177	Fastener Kits.....	18	Parking Lamp.....	206-207	Bolts.....	142	Door Panel.....	14	
Adjustment.....	153, 178	Interior Kits.....	2	Radio.....	56	Frame Brackets.....	142	Door Panel.....	14	
Bumpers.....	154, 178	Paint.....	13	Reverse Light.....	210	MSD	125-126	Door Panel.....	14	
Catch.....	178	Intermediate Steering Shaft	91, 136	Screws.....	207, 210			Door Panel.....	14	
Emblem.....	214	J		Side Marker.....	207			Door Panel.....	14	
Grille.....	141, 176	Jack		Shift Indicator.....	46-47, 94			Door Panel.....	14	
Hinge.....	178	Accessory Kit.....	60	Tail Lamp.....	208-210			Door Panel.....	14	
Hinge bolt.....	153, 178	Bumper Jack.....	60	Level				Door Panel.....	14	
Hood Pins.....	178	Decal (Instructions).....	221	Heater Control.....	37			Door Panel.....	14	
Insulation.....	149	Load Base.....	60	Tilt Wheel.....	37			Door Panel.....	14	
Latch.....	178-179	Retainer.....	60, 154	Turn Signal.....	37			Door Panel.....	14	
Latch Support.....	178	Junction Block	147, 200	License Plate				Door Panel.....	14	
Louvers.....	161	Junior Interior Kit	2	Bracket.....	168			Door Panel.....	14	
Tach.....	25	K		Hardware.....	154, 168			Door Panel.....	14	
Hooker	100, 111-112, 142	Kickdown		Lamp.....	210-211			Door Panel.....	14	
Horn	147	Cable.....	101, 104	Lighting	205-211			Door Panel.....	14	
Cap.....	34, 36	Harness.....	199	Locks	212-213			Door Panel.....	14	
Contact Kit.....	36	Kick Panels	39, 55	Louvers				Door Panel.....	14	
Relay.....	147, 202	Insulation.....	39	Fender.....	176			Door Panel.....	14	
Wire.....	199	Speakers.....	55	Hood.....	161			Door Panel.....	14	
Hose		Knob		Quarter Panel.....	159			Door Panel.....	14	
Bypass.....	133	Auto Shifter.....	40-47, 94-97	Luggage Rack	173			Door Panel.....	14	
Clamps.....	117, 133	Bucket Seat Release.....	12	Lug Nuts	62			Door Panel.....	14	
Convertible Top.....	59	Clock.....	26	Lug Wrench	60			Door Panel.....	14	
Filler Neck (Fuel).....	107	Dash.....	31-33					Door Panel.....	14	
Fittings.....	123, 133	Door Lock.....	20					Door Panel.....	14	
Fuel.....	137	Emergency Brake.....	41					Door Panel.....	14	
Headlamp (RS).....	172	Emergency Flasher.....	36					Door Panel.....	14	
Headlamp Washer.....	173	Headlamp.....	32					Door Panel.....	14	
Heater.....	117	Heater Control.....	38					Door Panel.....	14	
Hose Kits.....	117	Manual Shifter.....	40, 95					Door Panel.....	14	
Overflow.....	117	Radio.....	33, 56					Door Panel.....	14	
PCV.....	124	Seat Adjustment.....	12					Door Panel.....	14	
Power Brakes (to booster).....	70	Shifter.....	40-47, 94-97					Door Panel.....	14	
Power Steering.....	92, 135	Wiper Switch.....	32					Door Panel.....	14	
Radiator.....	117	K&N	120, 131					Door Panel.....	14	
Retainers.....	117	L						Door Panel.....	14	
Washer.....	145	Lakewood Bellhousing	105					Door Panel.....	14	
Hubcap	62-64	Latch						Door Panel.....	14	
Hurst		Convertible Top.....	58					Door Panel.....	14	
Installation Kits.....	39, 93-95	Door.....	181					Door Panel.....	14	
Shifter.....	39, 93-95	Hood.....	178-179					Door Panel.....	14	
		Trunk.....	188					Door Panel.....	14	
I		Leaf Springs	84-85					Door Panel.....	14	
Idle Arm	86	Hardware.....	84-85, 154					Door Panel.....	14	
Bolts.....	86, 154							Door Panel.....	14	
Ignition								Door Panel.....	14	
Coil.....	125, 204							Door Panel.....	14	
Lock Cylinder.....	212-213							Door Panel.....	14	
Switch.....	201							Door Panel.....	14	

Pedal Assembly.....73
 Switch.....72, 200
Parking Lamps.....206-207
 Bezel.....165
 Housing.....206-207
 Lens.....206-207
PCV.....124
Pedal
 Clutch/Brake.....39, 101
 Pads.....39
Pillar
 Molding.....52, 159
 Weatherstrip.....195
Pilot Bushing.....99
Pitman Arm.....86, 136
Plugs
 Plastic.....154
 Rubber.....154-155
Positraction
 Decal.....221
 Tag.....102
Power Brake
 Booster.....69
 Hose.....70
 Tube.....70
Power Seat Relay.....202
Power Steering
 Brackets.....93, 135-136
 Driver.....93, 135
 Gear Box.....91, 136
 Hardware.....91-93, 135-136, 154
 Hose.....92, 135
 Pulley.....93, 135-136
 Pump.....92, 135
Power Window
 Complete Kit.....193
 Harness.....199
 Harness Boot.....199
 Relay.....202
 Switch.....20, 193, 201
Power Top
 Cylinder.....59
 Frame.....58, 189
 Harness.....199
 Hoses.....59
 Switch.....58, 200
Pre-Assembled Seat.....3-4
Pressure Plate
 Bolts.....98, 155
 Throw Out Bearing.....99, 105
Printed Circuit Board.....202
Proportioning Valve.....70
Pulley
 Alternator.....139
 Billet.....133-139
 Bolts.....133-134, 155
 Crank.....133-134
 Power Steering.....93, 135
 Water Pump.....133
Pump
 Fuel.....139
 Power Steering.....92, 135
 Washer.....145
 Water.....132
PYPES Exhaust.....109

Q
Quarter Panel.....182
 Braces.....183
 Louvers.....159
 Patch.....182
Quarter Window
 Glass.....190
 Molding.....161
 Seal.....161, 195
Quick Fuel.....122, 138
QuietRide Acoustishield.....53

R
Radiator.....113-114
 Cap.....115
 Clamps.....117
 Fan Shroud.....116
 Hoses.....117
 Mounting.....115-116
 Overflow Jar.....115
 Support.....175
 Show Panel.....148
Radio.....54-56
 Bezel.....33, 56
 Capacitor.....55, 146
 Delete Plate.....55
 Face Plate.....33, 56
 Knobs.....33, 56
 Lens.....56
Rag Joint.....91, 136
Rally Sport
 Components.....169-173
 Conversion (67-69).....169-170
 Conversion (70-73).....173
 Fender.....174
 Fender Bracket.....172-173
 Grille.....162-164
 Headlamps.....169-172
 Relay Board.....171
 Stripe Kits.....217-219
Rear End
 Cover.....102
 Drain Plug.....102
 Fluid.....102
 Pinion Bumper.....85
 Posi Tag.....102
Rear Lamp Harness.....199
Rear Seat
 Brace.....187
 Cover.....3-6
 Divider.....185
 Floor Hook.....185
 Foam.....11
Rear Panel
 Inner Panel.....189
 Inner Panel Braces.....189
 Tail Lamp Panel.....188-189
Rear View Mirror.....50
 Bracket.....50
Rear Window
 Corner Trim.....52
 Glass.....190
 Window to Trunk Panel.....187
 Trim.....50-52
Receiver Drier (A/C).....143

Regulator
 Window (Front).....192
 Window (Rear).....192
 Voltage.....146
Remote Mirror.....160
 Bezel.....20
Repair Panel
 Cowl.....179-180
 Dash.....179-180
 Door Jamb.....181
 Fender.....175
 Package Tray.....187
 Quarter Panel.....182
Reverse Lamp.....210
 Lockout Kit.....40, 95
 Mounting Template.....210
 Switch.....103, 201
Rocker Panel.....183
 Molding.....160
Roof Panel.....189
 Brace Kit.....189
 Drip Rail.....189
 Drip Molding.....158
 Weatherstrip.....194
 Weatherstrip Channel.....158-189
Rotors.....72
Rubber Stopper Kit.....196

S
Sail Panels.....52
 Headliner Kit.....49
Seat.....3-13
 Adjustment Knob.....12
 Back Hook.....12
 Back Knob.....12
 Back Latch.....12
 Belt.....8-10
 Bolt (Seatbelt).....10, 155
 Cover.....3-7
 Emblems.....5
 Foam.....7, 11
 Frame.....11
 Installation Kit.....12
 Mounting Bolt.....13, 155
 Pre-Assembled Seats.....3-4
 Side Hinge Covers.....12
 Spring.....11
 Tracks & Extenders.....13
Sending Unit
 Fuel.....107
 Temperature.....147
Service Manual.....223
Shifter.....40, 94-97
 Ball.....40, 95
 Boot.....46-47, 95
 Cable.....97, 101
 Detent.....92, 94
 Kit.....47, 94-95
 Knob.....95
 Lens.....47, 94
 Plate.....47
 Seal Kit.....47
 Slider.....47, 94
 Tunnel.....47, 95
Sheet Metal.....174-189
 Screws.....155

Shocks.....81, 83, 89
 Coilover.....83, 89
 Decal.....221
 Hardware.....81, 155
 Spiral Shock.....81
 Tower.....186
Shop Manual Set.....223
Side Marker.....207
 Lens.....207
 Socket.....207
Side View Mirror.....159-160
Sill Plate.....42
Sound Deadener.....42, 44, 53
Southside Machine.....85
Spare Tire
 Anchor Plate.....60, 185
 Cover.....60
 Retainer.....60, 154
Spark Plug.....126, 204
 Heat Shields.....126
 Wires.....126, 204
Speakers
 Dash.....55
 Harness.....199
 Rear.....55-56
Speed Warning
 Cable.....103
 Harness.....199
Speedometer
 Cables.....103
 Gauge.....25
 Gear.....104
 Lens.....24
 Pulse Generator.....29
Spindles.....71
Spiral Shocks.....81
Spolier
 Decal.....221
 Front.....161
 Rear.....169
Spring
 Carb Return.....123
 Clutch Return.....99
 Decal.....220-221
 Coil.....78, 80
 Headlamp.....206
 Hinge (Door).....181
 Hinge (Hood).....178
 Lowering.....78,
 Seat.....11
Starter.....132
 Bolts.....132, 155
Steering
 Box.....91, 136
 Column.....37
 Column Parts.....37-38
 Column Seal.....195
 Coupler.....91, 136
Steering Wheel.....33-35
 Cap.....36
 Hub.....36
 Kit.....33-35
 Shroud.....36
Striker
 Door.....20, 152
 Glove Box.....32

Stripe Kits 217-219	Lever..... 38	Water Pumps..... 132	T-Tops..... 195
Subframe 186	Timing Cover 127	Tune Up Kit 203	Trunk..... 194
Connectors..... 77,88	Bolts..... 127,156	Turn Signal	Vent Window..... 195
Repair Plates..... 80,186	Pointer..... 127	Cancel Cam..... 36	Window Felts..... 196
Detroit Speed..... 77	Tires 64	Lever..... 38	Weiland Intake 123
Sunvisor 49-50	TMI Interiors	Switch..... 202	Wheels 61-64
Bushing..... 50	Console..... 44		Cap..... 62-64
Support..... 50,57	Dash Pads..... 20	U	Kits..... 61-64
Super Interior Kit 2	Door Panels..... 16	Undercover Innovations 148,176	Lug Nuts..... 62
Suspension 75-93	Headliner Kits..... 49	UMI Suspension 84,87-91	Paint..... 222
Sway Bar 78,82,86	Seat Covers..... 7	Under Hood Lamp 146,211	Trim Rings..... 63
Brackets..... 86	Toe Board 185		Wheel Opening Moldings 161
Bushings..... 86	Tools		Wheelhouse
Switch	Door Handle / Window Crank.....	V	Inner (Front)..... 175
Blower Motor..... 200 18,193	Vacuum Advance 124	Inner (Rear)..... 183
Brake Light..... 200	Door Panel..... 18,193	Cover..... 127	Outer (Rear)..... 183
Convertible Top..... 58,200	Glove Box Nut..... 30	Valance 179	Windlace
Door Jamb..... 200	Headlamp/Wiper Nut..... 30	Valve Cover 128-130	Door Jamb..... 20
Glove Box Light..... 201	Hog Ring Pliers..... 12	Decal..... 221	Universal per Ft..... 20
Ground Strap..... 201	Ignition Nut..... 30	Elbow..... 130	Window
Headlamp..... 201	Window Roller..... 193	Gasket..... 130	Crank..... 18,192
Headlamp Dimmer..... 201	Torque Box 185	Grommets..... 130	Glass (Door)..... 190
Ignition..... 201	Tower Clamp Kit 117	Hardware..... 130,156	Glass (Quarter)..... 190
Nut..... 201	Traction Bar 85	Hose..... 130	Glass (Rear)..... 190
Neutral Safety..... 201	Transmission	Oil Cap..... 130	Glass (Windshield)..... 190
Neutral Start..... 103,201	Bellhousing..... 98,105	Wire Loom..... 127	Glass Stop..... 190-191
Power Lock..... 202	Coolers..... 104	Vent Channel Run 195	Molding..... 157-158
Power Window..... 20,193,201	Cooler Lines..... 101	Vent Window	Molding Pin/Stud..... 157
Reverse..... 100,106	Crossmember..... 100	Frame..... 158	Regulator (Door)..... 192
TCS..... 102	Dipstick..... 104	Glass..... 190	Regulator (Rear)..... 192
Turn Signal..... 202	Hurst Installation Kit..... 40,95	Handle..... 191	Rollers..... 191-193
Wiper/Washer..... 202	Linkage..... 98-99	Hardware..... 158	Sticker..... 220-221
	Manual Conversion..... 41,98	Rivet..... 20	Switch..... 193
	Mount..... 100	Seal..... 195	Tracks..... 192-193
T	Pan..... 104	VHX Gauges 28	Trim..... 50-52
T-Top	Speedo Gear..... 104	Vintage Air 143	Window Felt 196
Clip..... 52	Tail Seal..... 102	Vinyl Top 158	Windshield Wipers
Handle..... 52	Vacuum Lines..... 101	Moldings..... 158	Blades..... 157
Molding..... 52	Yoke..... 102	Voltage Regulator 146,202	Knob..... 32
Weatherstrip..... 195	Trim Rings 63	Screws..... 146,156	Motor..... 145
Tachometer 25-26	Trunk		Switch..... 202
Conversion Harness..... 199	Bumper Jack..... 60	W	Transmission..... 157
Hood Tach..... 25	Divider Board..... 53	Washer	Wiring Diagram 197
Taillights 208-211	Floor..... 186-187	Cap..... 145	Wiring Harness 197-200
Bezel..... 208	Floor Drop Off..... 186	Hose Kit..... 145	Wire Loom 127
Lens..... 208-209	Floor Drain Plug..... 60,186	Jar..... 145	
Panel..... 188-189	Hinge..... 186	Nozzles..... 145	X
Rear Lamp Harness..... 199	Lamp Harness..... 199	Pump..... 145	X-Pipe 109-111
Socket..... 210	Latch..... 188	Water Pump 132	
TCS	Lid..... 187	Attaching Kit..... 133	Y
Relay..... 202	Lid Catch..... 60,188	Bypass Hose..... 133	Yenko Stripe Kits 217
Solenoid..... 124	Lock..... 212-213	Pulley..... 133	
Switch..... 102	Lock Bezel..... 60,213	Stud..... 133,156	Z
Trans. Switch Harness..... 199	Lug Wrench..... 60	Weatherstrip 194-196	Z-Bar 98-99
Temperature Sending Unit 147,204	Mat..... 60	Convertible..... 194-195	Z/28
Thermostat 124	Paint..... 60,222	Deluxe Kits..... 194	Stripe Kit..... 217-219
Bolts..... 124,155	Spare Tire Cover..... 60	Door..... 194	
Housing..... 124	Torsion Bars..... 60,188	Dust Shields..... 195	
Throttle	Weatherstrip..... 60,194	Firewall Seals..... 195	
Bracket..... 120-121,123	Weatherstrip Gutter..... 60,187	Glue..... 195	
Cable..... 39,121	Tubular Control Arms 79,82,87	Gutter..... 60,187	
Linkage..... 39,121	Tuff Stuff	Junior Kits..... 194	
Throw Out Bearing 99,105	Alternators..... 139	Paint Seal Kits..... 195	
Tie Rod 86	Power Steering Pump..... 92,135	Pillar Post..... 195	
Tilt	Starters..... 132	Quarter Glass..... 191,195	
Column..... 37		Roof Rail..... 194	

Billing Address

Name _____
 Address _____
 Address 2 _____
 City _____ State _____ Zip _____
 Home Phone _____
 Business Phone _____
 E-Mail _____

Shipping Address

Name _____
 Address _____
 Address 2 _____
 City _____ State _____ Zip _____

Special Comments

Vehicle Information Year _____ Model _____
 Body Style _____ Engine _____ Trans _____
 Interior Color _____ Exterior Color _____
 (Circle any applicable) A/C • Buckets or Bench • PBrakes
 Other information to help us better understand your vehicle _____

Page#	Part#	Quantity	Description	Price (each)	Total Price

Payment Type: Check Money Order Credit Card

Card # _____

Expires ____ / ____ CVV code _____

Authorized Signature _____



Subtotal	
6.35% CT Sales Tax (CT only)	
Shipping & Handling see chart	
Insurance	
1st \$100 free -\$1 per 100	
Total	

*All checks are held for 21 business days. All money orders are held for 7 business days. Ground Up does not accept COD orders.

Shipping & Handling Guide
 Shipping charges are based on actual shipping charges and are listed below as approximate estimates for UPS Ground. Your actual shipping & handling charge may be more or less than the amounts listed below. Use this chart as a guide.

Orders up to \$25.....Add \$8.95 \$25.01 to \$40.00.....Add \$10.95 \$40.01 to \$60.00.....Add \$14.95 \$60.01 to \$75.00.....Add \$17.95 \$75.01 to \$100.00.....Add \$20.95 \$100.01 to \$150.00.....Add \$24.95 \$150.01 to \$200.00.....Add \$27.95 \$200.01 to \$300.00.....Add \$32.95 \$300.01 to \$400.00.....Add \$36.95 \$400.01 to \$500.00.....Add \$42.95 \$500.01 to \$600.00.....Add \$49.95 \$600.01 to \$1000.00.....Add \$54.95	UPS Oversize 1..... each item Add \$19.95 UPS Oversize 2..... each item Add \$39.95 Insurance..... per \$100.00..... Add \$1.00 Truck Freight Commercial..... Call Truck Freight Residential..... Call International..... Call
--	---

This chart does not apply to truck freight and international orders. All truck freight and international orders must be quoted by a Ground Up customer service representative. Please call 1-866-358-2277 to receive your shipping quote today!

*Charges below still apply

Company Policies

Hassle Free Returns

Ground Up Inc® prides itself on providing you with an excellent experience, so if you are not completely satisfied with your order for any reason, you may return parts for a full refund, credit or even exchange within 30 days of receipt (not including any shipping). (All returns are subject to a 25% restocking fee after 30 days.) Return shipping and handling is the sole responsibility of the customer and Ground Up Inc® will not be held responsible for any additional costs on returned items. We cannot accept returns on any product that has been modified, altered, painted, installed or disassembled in any way. Ground Up Inc® always recommends professional installation and is not responsible or liable for any labor fees associated with the installation, removal, modification or repair of any product purchased regardless of circumstances. Ground Up Inc® is not responsible for any damage or discoloration of products incurred in relation to chemical products including cleaners, waxes, polishes, paints, etc. Gift certificates have no cash value and must be redeemed for merchandise only. **All returns must be approved by a customer service representative. Returns MUST be accompanied by a RMA # which will be provided by a customer service representative.**

Product Availability & Pricing

Every part listed in this catalog was available or planned as a reproduction at the time of printing. We reserve the right to substitute products of similar nature and quality. Prices in this catalog were effective at the time of printing and supersede those in all previous publications. Ground Up Inc® makes every effort to honor prices herein. However, due to increased costs of materials, etc. we reserve the right to change prices without notice.

Backorders

Your invoice will notate any items that were out of stock at the time of shipping. The unavailable items will be back ordered unless otherwise specified on your order form or verbally to a sales rep when placing an order by phone. Back orders are usually shipped as soon as the products arrive at our warehouse without prior notification. Ground Up Inc® will make an effort to contact the customer if the back order is more than 90 days old. If you wish to cancel a back ordered item, please notify our customer service department immediately.

Kit Products

Ground Up Inc is proud to offer many convenient and money saving kits. On occasion kit components will be short on stock. In that scenario the customer will have the choice of shipping out the in stock components while waiting for the missing components to be shipped when they come back in stock OR waiting for all the parts to be in stock before Ground Up ships the whole kit. **Kits are not eligible for further discount (i.e. Free shipping).**

Color Matches

Due to multiple manufacturers of products, color variations may occur. Slight color variations are common (especially among interior products) and do not constitute a defect. Ground Up Inc® will not be held responsible for return shipping on items for this reason.

Discounting

Ground Up Inc® is proud to offer you several ways to save money. Orders over \$900.00 are eligible for 10% off. These offers do not apply to kit items, sale items, specially priced items and any items marked "No Volume Discount". All items on the order must be in stock at time of ordering. Ground Up Inc® reserves the right to exclude items for discounting that may not be noted as "No Volume Discount" in this catalog. **Discounts (including free shipping) cannot be combined.**

Sales Tax Information

Orders shipped outside of CT may be exempt from sales tax. CT residents are required to add the appropriate current sales tax to all orders including shipping and handling. The current rate at time of printing is 6.35%.

Ordering Lefts and Rights

Some items in this catalog are presented as right hand (RH) or left hand (LH). RH and LH sides are determined by sitting in the vehicle. RH = passenger and LH = driver.

Trademark and Copyright

The Ground Up Inc® Parts and Accessories catalog is copyrighted. No part of this publication including text, photos or illustrations may be reproduced without the prior written permission of Ground Up Inc®.

International Orders

Ground Up Inc® is happy to ship parts to overseas customers via International Economy shipping. Shipping can also be arranged per the customer and the packages will be boxed at our dock. Please call our sales department or send an email to logistics@ss396.com to get a shipping quote for the parts that you wish to order.

Shipping Information

Free Shipping

Orders over \$299.00 are eligible for free standard UPS Ground shipping on in stock items only. Oversize items, items which must be shipped truck freight, drop ship items, back ordered items and specially priced items are not eligible for free shipping. Ground Up Inc® reserves the right to charge shipping on any item that cannot be shipped regular UPS Ground even though an item may not be designated as "Oversize" or "Truck Freight" in this catalog. Free shipping can't be combined with any other discount.

Oversize Items

All items which are considered to be Oversize are items that can be shipped via UPS Ground at an Oversize rate indicating a minimum dimensional weight fee of 30lbs for Oversize or 70lbs for Oversize 2. Ground Up Inc® reserves the right to charge an Oversize fee on any item that is Oversize even though it may not be indicated as an Oversize item.

Truck Freight

Some products in this catalog are too large or heavy to be shipped via Ground freight and must be shipped via truck freight. Ground Up Inc® charges a minimum of \$199.00 for all orders which must be shipped via Truck Freight to a commercial address. Actual rates can be higher depending on your location and items ordered. Residential addresses require an additional \$150.00, so please provide a commercial address whenever possible. If a commercial address is not available, you can arrange pickup at the closest terminal. (Your sales rep can provide you with the location.) If an address is not deemed to be a commercial address by the carrier, additional charges may apply. These charges are the sole responsibility of the customer.

Expedited Shipping

Ground Up Inc® offers several expedited shipping methods for your convenience: UPS 3 Day Saver • UPS 2 Day Air • UPS Overnight Orders must be placed by 2:00pm Mon-Fri. Weekends and holidays do not count as shipping days. Ground Up Inc® is not responsible for lost or damaged goods due to carrier mishandling. You must contact our sales department for actual shipping rates.

Insurance

Each order is charged an insurance fee of \$1.00 per \$100.00 to insure the entire order and protect you completely from damages or loss in shipping.

AP0/FPO

Parcel post is the only means of shipping to an APO or FPO address. Due to size restrictions, the maximum shipping box cannot exceed 72" width and girth combined. All military personal must write, call or email us prior to ordering to ensure that the desired parts do not exceed the size limit.

Damage Claims

Ground Packages - Always check the contents of your delivery in the presence of the person delivering the merchandise. Should any damage be present, immediately notify our customer service department so that Ground Up Inc® can take all necessary steps to file a claim with the carrier and ensure a prompt replacement of the damaged goods. Replacement parts will normally be sent out within 2 business days after receipt of a claim number from the carrier. Ground Up Inc® is not responsible for any damaged good that have not been reported within 3 business days of receipt of delivery. If the customer files a claim with the carrier, Ground Up Inc® will not be responsible to pay for any replacements until the carrier pays the claim.

Truck Freight - You MUST check the contents of your delivery in the presence of the carrier! **DO NOT ALLOW THE DELIVERY PERSON TO LEAVE PRIOR TO CHECKING YOUR SHIPMENT!** Should there be any damage, you MUST note the damage on the Bill of Lading. If the damage is beyond repair, **REFUSE THE SHIPMENT!** The Bill of Lading is a legal document. Should you accept the shipment and sign the Bill of Lading stating the items you received are in good condition without checking them, there is **NO RECOURSE** with the carrier if the goods are later found to be damaged. If items are discovered to be damaged at the time of delivery and noted as damaged on the Bill of Lading or refused, immediately notify our customer service department so that Ground Up Inc® can take all steps necessary to ensure a prompt replacement or adjustment on the damaged goods.

Shortages

Always check the contents of your delivery to ensure that all parts ordered were received. If you are missing any items, first check your invoice to check for back-orders or drop shipments before calling our customer service department. If a shortage has occurred, please contact our customer service department immediately for a prompt replacement. Ground Up Inc® is not responsible for any delivery shortages after 3 business days.

Refusals

All refused deliveries will be subject to a 25% restocking fee plus return shipping charges (unless it was refused because of damage in shipping. See our damage claim policy above).

This 2020a catalog now supersedes all previous catalogs.

Billing Address

Name _____
 Address _____
 Address 2 _____
 City _____ State _____ Zip _____
 Home Phone _____
 Business Phone _____
 E-Mail _____

Shipping Address

Name _____
 Address _____
 Address 2 _____
 City _____ State _____ Zip _____

Special Comments

Vehicle Information Year _____ Model _____
 Body Style _____ Engine _____ Trans _____
 Interior Color _____ Exterior Color _____
 (Circle any applicable) A/C • Buckets or Bench • PBrakes
 Other information to help us better understand your vehicle _____

Page#	Part#	Quantity	Description	Price (each)	Total Price

Payment Type: Check Money Order Credit Card

Card # _____

Expires ____/____ CVV code _____

Authorized Signature _____



Subtotal	
6.35% CT Sales Tax (CT only)	
Shipping & Handling see chart	
Insurance 1st \$100 free -\$1 per 100	
Total	

*All checks are held for 21 business days. All money orders are held for 7 business days. Ground Up does not accept COD orders.

Shipping & Handling Guide

Shipping charges are based on actual shipping charges and are listed below as approximate estimates for UPS Ground. Your actual shipping & handling charge may be more or less than the amounts listed below. Use this chart as a guide.

Orders up to \$25.....Add \$8.95	UPS Oversize 1..... each item.....Add \$19.95
\$25.01 to \$40.00.....Add \$10.95	UPS Oversize 2..... each item.....Add \$39.95
\$40.01 to \$60.00.....Add \$14.95	Insurance..... per \$100.00.....Add \$1.00
\$60.01 to \$75.00.....Add \$17.95	Truck Freight Commercial..... Call
\$75.01 to \$100.00.....Add \$20.95	Truck Freight Residential..... Call
\$100.01 to \$150.00.....Add \$24.95	International..... Call
\$150.01 to \$200.00.....Add \$27.95	
\$200.01 to \$300.00.....Add \$32.95	
\$300.01 to \$400.00.....Add \$36.95	
\$400.01 to \$500.00.....Add \$42.95	
\$500.01 to \$600.00.....Add \$49.95	
\$600.01 to \$1000.00.....Add \$54.95	

*Charges below still apply

This chart does not apply to truck freight and international orders. All truck freight and international orders must be quoted by a Ground Up customer service representative. Please call 1-866-358-2277 to receive your shipping quote today!

Company Policies

Hassle Free Returns

Ground Up Inc® prides itself on providing you with an excellent experience, so if you are not completely satisfied with your order for any reason, you may return parts for a full refund, credit or even exchange within 30 days of receipt (not including any shipping). (All returns are subject to a 25% restocking fee after 30 days.) Return shipping and handling is the sole responsibility of the customer and Ground Up Inc® will not be held responsible for any additional costs on returned items. We cannot accept returns on any product that has been modified, altered, painted, installed or disassembled in any way. Ground Up Inc® always recommends professional installation and is not responsible or liable for any labor fees associated with the installation, removal, modification or repair of any product purchased regardless of circumstances. Ground Up Inc® is not responsible for any damage or discoloration of products incurred in relation to chemical products including cleaners, waxes, polishes, paints, etc. Gift certificates have no cash value and must be redeemed for merchandise only. **All returns must be approved by a customer service representative. Returns MUST be accompanied by a RMA # which will be provided by a customer service representative.**

Product Availability & Pricing

Every part listed in this catalog was available or planned as a reproduction at the time of printing. We reserve the right to substitute products of similar nature and quality. Prices in this catalog were effective at the time of printing and supersede those in all previous publications. Ground Up Inc® makes every effort to honor prices herein. However, due to increased costs of materials, etc. we reserve the right to change prices without notice.

Backorders

Your invoice will notate any items that were out of stock at the time of shipping. The unavailable items will be back ordered unless otherwise specified on your order form or verbally to a sales rep when placing an order by phone. Back orders are usually shipped as soon as the products arrive at our warehouse without prior notification. Ground Up Inc® will make an effort to contact the customer if the back order is more than 90 days old. If you wish to cancel a back ordered item, please notify our customer service department immediately.

Kit Products

Ground Up Inc is proud to offer many convenient and money saving kits. On occasion kit components will be short on stock. In that scenario the customer will have the choice of shipping out the in stock components while waiting for the missing components to be shipped when they come back in stock OR waiting for all the parts to be in stock before Ground Up ships the whole kit. **Kits are not eligible for further discount (i.e. Free shipping).**

Color Matches

Due to multiple manufacturers of products, color variations may occur. Slight color variations are common (especially among interior products) and do not constitute a defect. Ground Up Inc® will not be held responsible for return shipping on items for this reason.

Discounting

Ground Up Inc® is proud to offer you several ways to save money. Orders over \$900.00 are eligible for 10% off. These offers do not apply to kit items, sale items, specially priced items and any items marked "No Volume Discount". All items on the order must be in stock at time of ordering. Ground Up Inc® reserves the right to exclude items for discounting that may not be noted as "No Volume Discount" in this catalog. **Discounts (including free shipping) cannot be combined.**

Sales Tax Information

Orders shipped outside of CT may be exempt from sales tax. CT residents are required to add the appropriate current sales tax to all orders including shipping and handling. The current rate at time of printing is 6.35%.

Ordering Lefts and Rights

Some items in this catalog are presented as right hand (RH) or left hand (LH). RH and LH sides are determined by sitting in the vehicle. RH = passenger and LH = driver.

Trademark and Copyright

The Ground Up Inc® Parts and Accessories catalog is copyrighted. No part of this publication including text, photos or illustrations may be reproduced without the prior written permission of Ground Up Inc®.

International Orders

Ground Up Inc® is happy to ship parts to overseas customers via International Economy shipping. Shipping can also be arranged per the customer and the packages will be boxed at our dock. Please call our sales department or send an email to logistics@ss396.com to get a shipping quote for the parts that you wish to order.

Shipping Information

Free Shipping

Orders over \$299.00 are eligible for free standard UPS Ground shipping on in stock items only. Oversize items, items which must be shipped truck freight, drop ship items, back ordered items and specially priced items are not eligible for free shipping. Ground Up Inc® reserves the right to charge shipping on any item that cannot be shipped regular UPS Ground even though an item may not be designated as "Oversize" or "Truck Freight" in this catalog. Free shipping can't be combined with any other discount.

Oversize Items

All items which are considered to be Oversize are items that can be shipped via UPS Ground at an Oversize rate indicating a minimum dimensional weight fee of 30lbs for Oversize or 70lbs for Oversize 2. Ground Up Inc® reserves the right to charge an Oversize fee on any item that is Oversize even though it may not be indicated as an Oversize item.

Truck Freight

Some products in this catalog are too large or heavy to be shipped via Ground freight and must be shipped via truck freight. Ground Up Inc® charges a minimum of \$199.00 for all orders which must be shipped via Truck Freight to a commercial address. Actual rates can be higher depending on your location and items ordered. Residential addresses require an additional \$150.00, so please provide a commercial address whenever possible. If a commercial address is not available, you can arrange pickup at the closest terminal. (Your sales rep can provide you with the location.) If an address is not deemed to be a commercial address by the carrier, additional charges may apply. These charges are the sole responsibility of the customer.

Expedited Shipping

Ground Up Inc® offers several expedited shipping methods for your convenience: UPS 3 Day Saver • UPS 2 Day Air • UPS Overnight Orders must be placed by 2:00pm Mon-Fri. Weekends and holidays do not count as shipping days. Ground Up Inc® is not responsible for lost or damaged goods due to carrier mishandling. You must contact our sales department for actual shipping rates.

Insurance

Each order is charged an insurance fee of \$1.00 per \$100.00 to insure the entire order and protect you completely from damages or loss in shipping.

AP0/FPO

Parcel post is the only means of shipping to an APO or FPO address. Due to size restrictions, the maximum shipping box cannot exceed 72" width and girth combined. All military personal must write, call or email us prior to ordering to ensure that the desired parts do not exceed the size limit.

Damage Claims

Ground Packages - Always check the contents of your delivery in the presence of the person delivering the merchandise. Should any damage be present, immediately notify our customer service department so that Ground Up Inc® can take all necessary steps to file a claim with the carrier and ensure a prompt replacement of the damaged goods. Replacement parts will normally be sent out within 2 business days after receipt of a claim number from the carrier. Ground Up Inc® is not responsible for any damaged good that have not been reported within 3 business days of receipt of delivery. If the customer files a claim with the carrier, Ground Up Inc® will not be responsible to pay for any replacements until the carrier pays the claim.

Truck Freight - You MUST check the contents of your delivery in the presence of the carrier! DO NOT ALLOW THE DELIVERY PERSON TO LEAVE PRIOR TO CHECKING YOUR SHIPMENT! Should there be any damage, you MUST note the damage on the Bill of Lading. If the damage is beyond repair, REFUSE THE SHIPMENT! The Bill of Lading is a legal document. Should you accept the shipment and sign the Bill of Lading stating the items you received are in good condition without checking them, there is NO RECOURSE with the carrier if the goods are later found to be damaged. If items are discovered to be damaged at the time of delivery and noted as damaged on the Bill of Lading or refused, immediately notify our customer service department so that Ground Up Inc® can take all steps necessary to ensure a prompt replacement or adjustment on the damaged goods.

Shortages

Always check the contents of your delivery to ensure that all parts ordered were received. If you are missing any items, first check your invoice to check for back-orders or drop shipments before calling our customer service department. If a shortage has occurred, please contact our customer service department immediately for a prompt replacement. Ground Up Inc® is not responsible for any delivery shortages after 3 business days.

Refusals

All refused deliveries will be subject to a 25% restocking fee plus return shipping charges (unless it was refused because of damage in shipping. See our damage claim policy above).

This 2020a catalog now supersedes all previous catalogs.



CELEBRATING

30
YEARS



**“Helping Restore
Classic American
Muscle Since 1990”**

Contact Us:

U.S. & Canada: (866) 358-2277
International: (203)-235-1200

Parts Call Center Hours (EST)

Monday - Thursday: 9AM - 6PM
Friday: 9AM - 3PM
Saturday: 9AM - 1PM

Parts Pick Up Hours (EST)

Tuesday - Thursday: 9AM - 5PM
Friday: 9AM - 2PM
Saturday: 9AM - 1PM

Location

Ground Up - SS396
91 Great Hill Rd
Naugatuck, CT 06770 US

We love showing off our customer's cars just as much as we love showing off our cars!

- Submit your car to be featured-

www.ss396.com/cars/customer-car-submission

**Fahad AL-Odah
1969 Camaro**



SCAN ME



**ARAB
MOTOR
WORLD**

PAUL CENNAME 1972 NOVA



**BRIAN PUCHALSKI'S
1969 CHEVELLE SS396
CONVERTIBLE**



Can't Find The Part You Need?

Go online to SS396.COM to access and shop thousands of parts and accessories for your Camaro.

Have Another Car?

Don't forget to request and get a Nova or Chevelle & El Camino Catalog today.



GROUND UP INC.
91 GREAT HILL ROAD
NAUGATUCK, CT 06770

PRSR STD
U.S.POSTAGE
PAID
MERIDEN CT 06450
PERMIT NO. 36

CURRENT RESIDENT OR:

