



### HARDWARE KITS

Detail shot of a Master Body Hardware kit. These kits have all of the hard to find items that are not available anywhere else!



#### AMK Master Body Hardware Kit

Master body kits contain just about every piece of hardware to assemble the body of your Chevelle. Each kit contains hardware for your battery tray, bumpers, filler panel, filler panel moldings, bumper brackets, cowl vent panel, door latches, emblems, eyebrows, fender braces, fenders, front tie bar, grille, grille brackets, grille moldings, headlamps, headlamps bezels, hood, hood hinges, hood latch, hood latch support, license plate, mirrors, parking lamps, tail lamps, trunk latch, trunk lid hinges, wheel opening moldings, wheel houses, radiator support and more! This kit truly has it all!

64AB	1964 Chevelle	239.99 kit
65AB	1965 Chevelle	227.99 kit
66AB	1966 Chevelle	239.99 kit
67AB	1967 Chevelle	235.99 kit
68AB	1968 Chevelle	244.99 kit
69AB	1969 Chevelle	229.99 kit
70AB	1970 Chevelle	227.99 kit
71AB	1971 Chevelle	227.99 kit
64EB	1964 El Camino	263.99 kit
65EB	1965 El Camino	265.99 kit
66EB	1966 El Camino	274.99 kit
67EB	1967 El Camino	259.99 kit
68EB	1968 El Camino	262.99 kit
69EB	1969 El Camino	244.99 kit
70EB	1970 El Camino	244.99 kit
71EB	1971 El Camino	255.99 kit

#### Engine Master Hardware Kits

The authentic hardware you need to correctly reassemble the engine components that attach to the long block. Typical kits include fasteners for: air cleaner, carburetor & choke cover, crank pulley & damper, distributor, exhaust manifold, exhaust pipe, engine fan, fuel pump plate & plug, heat shield, ignition coil & strap, intake manifold & plug, oil filter valve, oil pan, PCV adapter, PCV hose clamps, timing cover, valve covers, water neck, water pump.

67-Z28	1967-68 SB (174 pc)	107.99 kit
66-SBS	1968 SB w/o AC (153 pc)	109.99 kit
66-SBA	1968 SB w/ AC (164 pc)	97.99 kit
68-BBH	1968 BB Aluminum Intake (149 pc)	123.99 kit
68-BBS	1968 BB Cast Iron Intake (159 pc)	108.99 kit
69-SB	1969-71 SB (170 pc)	97.99 kit
69-Z28	1969 SB (162 pc)	109.99 kit
69-BBH	1969-72 BB Aluminum Intake (149 pc)	117.99 kit
69-BBS	1969-72 BB Cast Iron Intake (143 pc)	99.99 kit
72-SB	1972-73 SB (139 pc)	112.99 kit
72-Z28	1972-73 (145 pc)	108.99 kit

No Volume Discount.

#### OEM Bolts - They Just Make Sense!

It makes sense to use new bolts on new or restored parts! From bumper to bumper, we cover your entire vehicle. We have made our name and reputation on providing those hard to find detailing parts that separates your classic from the rest. All of our bolts are either original, OEM parts from original GM manufacturers or top quality reproductions. Manufactured with original head markings and correct plating (zinc, black phosphate and oiled, gold cadmium and silver cadmium), these bolts make assembly a breeze! Like our OEM paints, new bolt sets are what make a top flight restoration!



#### AMK Interior Screw Kit

64AN-CP	1964-65 Chevelle Coupe	138.99 set
64AN-CV	1964-65 Chevelle Convertible	133.99 set
66AN-CP	1966 Chevelle Coupe	143.99 set
66AN-CV	1966 Chevelle Convertible	130.99 set
67AN-CP	1967 Chevelle Coupe	158.99 set
67AN-CV	1967 Chevelle Convertible	147.99 set
68AN-CP	1968 Chevelle Coupe	163.99 set
68AN-CV	1968 Chevelle Convertible	150.99 set
69AN-CP	1969 Chevelle Coupe	167.99 set
69AN-CV	1969 Chevelle Convertible	159.99 set
70AN-CP	1970-72 Chevelle Coupe	195.99 set
70AN-CV	1970-72 Chevelle Convertible	185.99 set

#### AC Box Under Hood Hardware

All the hardware related to the AC under the hood on the firewall forwards.

64AA-F	1964-65	29.99 kit
66AA-F	1966	42.99 kit
67AA-F	1967	28.99 kit
68AA-F	1968	46.99 kit
69AA-F	1969	52.99 kit
70AA-F	1970-72	40.99 kit

#### AC On Engine Hardware

All the hardware related to the AC brackets on the engine.

64AA-SB	1964-65 SB	32.99 kit
66AA-SB	1966-67 SB	35.99 kit
66AA-BB	1966 BB	47.99 kit
67AA-SSB	1967 SB w/ Smog	36.99 kit
67AA-BB	1967 BB	46.99 kit
68AA-SB	1968 SB	28.99 kit
68AA-SSB	1968 SB w/ Smog	31.99 kit
68AA-BB	1968 BB	47.99 kit
69AA-SB	1969 SB	51.99 kit
69AA-BB	1969 BB	39.99 kit
70AA-SB	1970 SB	41.99 kit
70AA-BB	1970-72 BB	39.99 kit
71AA-SB	1971 SB	38.99 kit
72AA-SB	1972 SB	40.99 kit

#### Master Chassis Kit

Typical kit includes fasteners to attach: accelerator lever & support, axle housing, springs, axle retainer plates, brake booster & hose, brake cables, brake plates, brake hose retainers & brackets, brake valve & pressure switch, calipers & brackets & shields, upper & lower control arms, control arm bushings, differential cover, driveshaft, engine mounts, fuel filler neck cover, fuel hoses, gas tank, grease fittings, idler arm, master cylinder & push rod, parking brake control, pitman arm, radius rod & bracket & bumper, shocks & brackets, stabilizer bar brackets and end links (includes rubber), steering gear & rag joint, steering linkage & ball joints, speedometer cable, trans, suspension bumper, transmission crossmember & insulator, wheel cylinders.

64AS-SB	1964-67 SB Drum Brakes (331 pc)	244.99 kit
65AS-BB	1965-67 BB Drum Brakes (339 pc)	240.99 kit
67AS-DCSB	1967 SB Disc Brakes (340 pc)	260.99 kit
67AS-BB	1967 BB Disc Brakes (338 pc)	250.99 kit
68AS-DRSB	1968 SB Drum Brakes (341 pc)	244.99 kit
68AS-DCSB	1968 SB Disc Brakes (346 pc)	273.99 kit
68AS-BB	1968 BB Disc Brakes (345 pc)	255.99 kit
69AS-DRSB	1969 SB Drum Brakes (339 pc)	244.99 kit
69AS-DCSB	1969 SB Disc Brakes (337 pc)	270.99 kit
69AS-BB	1969 BB Disc Brakes (349 pc)	310.99 kit
70AS-DRSB	1970 SB Drum Brakes (335 pc)	255.99 kit
70AS-DCSB	1970 SB Disc Brakes (333 pc)	289.99 kit
70AS-BB	1970 BB Disc Brakes (349 pc)	310.99 kit
71AS-DRSB	1971-72 SB Drum Brakes (337 pc)	250.99 kit
71AS-DCSB	1971-72 SB Disc Brakes (337 pc)	275.99 kit
71AS-BB	1971-72 BB Disc Brakes (352 pc)	283.99 kit

No Volume Discount.

#### AC Box Under Dash Hardware

All the hardware related to the AC under the dash.

64AA-R	1964-65	22.99 kit
66AA-R	1966	26.99 kit
67AA-R	1967	31.99 kit
68AA-R	1968	31.99 kit
69AA-R	1969	32.99 kit
70AA-R	1970	28.99 kit
71AA-R	1971	26.99 kit
72AA-R	1972	26.99 kit



**HARDWARE KITS**

BFE-8002



**Front End Fastener Kits**

Over 175 pieces individually bagged!  
Includes everything you need to assemble your front end!



BFE-8001	1964-67 All .....	55.99 kit
BFE-8002	1968-72 All .....	55.99 kit



**Interior Screw Kits**

**Basic**

ISK-64A	1964-67 Chevelle .....	22.95 kit
ISK-68A	1968-69 Chevelle .....	23.95 kit
ISK-70A	1970-72 Chevelle .....	24.95 kit
ISK-64E	1964-72 El Camino .....	21.95 kit



**OEM Complete**

64AN-CP	1964-65 Chevelle Coupe .....	138.99 set
64AN-CV	1964-65 Chevelle Convertible .....	133.99 set
66AN-CP	1966 Chevelle Coupe .....	143.99 set
66AN-CV	1966 Chevelle Convertible .....	130.99 set
67AN-CP	1967 Chevelle Coupe .....	158.99 set
67AN-CV	1967 Chevelle Convertible .....	147.99 set
68AN-CP	1968 Chevelle Coupe .....	163.99 set
68AN-CV	1968 Chevelle Convertible .....	150.99 set
69AN-CP	1969 Chevelle Coupe .....	167.99 set
69AN-CV	1969 Chevelle Convertible .....	159.99 set
70AN-CP	1970-72 Chevelle Coupe .....	195.99 set
70AN-CV	1970-72 Chevelle Convertible .....	185.99 set

**HARDWARE PARTS**

AWB-1114



**Alternator Upper Adjustment Kit**

Correct WB head marked bolt with washers.

AWB-1114	1964-72 All .....	5.99 kit
----------	-------------------	----------



**Alternator Lower Attaching Hardware**

BRB-938	1969-72 SB Bolt .....	4.95 ea.
BN-339	1969-72 BB Stud .....	10.99 ea.



**Alternator Spacer Brace**

APX-1038	1969-72 BB .....	15.95 ea.
----------	------------------	-----------



**Alternator Neg Cable Bolt**

AW-506	All .....	0.95 ea.
--------	-----------	----------



**Alternator Fan Nut**

ABN-105	All .....	3.99 ea.
---------	-----------	----------



**Arm Rest Pads Screws**

OE style reproduction arm rest pad screws.

IXP-03	Attaching Screw .....	0.50 ea.
--------	-----------------------	----------



**Brake Cable Retainer**

Correct clip for all cars (3 required).

NX-281	1964-72 All .....	2.99 ea.
--------	-------------------	----------



**Bumper Bolts**

Correct chrome pan head bumper bolts complete with hardware. 7/16" x 1".

BPB-716	All .....	1.95 ea.
BPB-716K	All (8 pc.) .....	15.95 kit



**Brake Caliper Bolts**

Correct bolts/pins for mounting caliper to bracket. Two per caliper.

BMP-1000	1964-72 Single Piston .....	2.99 ea.
----------	-----------------------------	----------

*Single piston calipers only.*



ELC-316

ELC-1316



ELC-516

ELC-1516



ELC-10P

BLC-056

**Brake Line Clips**

Correct clips for attaching hard brake lines to frame. (Tabbed clips push into frame holes.)

ELC-316	3/16" Front .....	2.99 ea.
ELC-1316	3/16" w/ Tab .....	2.99 ea.
ELC-1516	5/16" Main .....	3.99 ea.
ELC-516	5/16" w/ Tab .....	3.99 ea.
ELC-038T	3/8" w/ Tab* .....	3.95 ea.
ELC-10P	Double Push In .....	3.95 ea.
BLC-056	Clip Bolt .....	0.50 ea.

*\*Use on main line with armor shielding.*



BHP-1645



BHP-0516



**Body Bolt Kit**

Correct black flanged head bolts and washers.

BHP-1643	1964-67 Coupe/El Camino .....	19.95 kit
BHP-1645	1964-67 Convertible .....	21.95 kit
BHP-0516	1968-72 Coupe/El Camino .....	22.95 kit
BHP-0517	1968-72 Convertible .....	23.95 kit



**Body Cage Nuts**  
BCN-716 All 7/16"..... 8.95 ea.



**Bed & Tailgate Bolt Kit**  
Complete kit with all correct bolts and screws for hinges, tailgate and bed floor.  
RSK-E7 1968-72 El Camino ..... 46.95 kit



**Bumper Bracket Bolts**  
New bumper bracket bolts with correct teeth washers and nut.  
BBF-13 All ..... 6.99 ea.



**Bezel Attaching Kits**  
Basic hardware kit for installation of bezels.  
BAG-D1 1964-67 All ..... 5.95 kit  
BAG-D2 1968-72 All ..... 5.95 kit

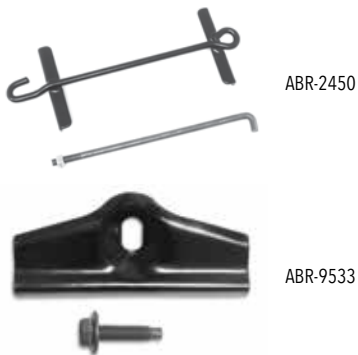

**Battery Retainer Kits**  
ABR-2450 1964-65 All ..... 15.95 kit  
ABR-9533 1966-72 All ..... 3.95 kit



**Bench Seat Washers**  
These washers go between the seat and the hinge on all bench seat cars. It keeps the hinge from damaging the seat material.  
BSW-180070 All ..... 3.99 pr.



**Bellhouse Attaching Kit**  
BPB-9021 1964-77 All (6 pc.) ..... 8.95 kit



**Carb Studs**  
Correct carb studs for cowl induction.  
AP-315 Holley ..... 12.95 ea.  
AP-317 Q-Jet ..... 13.95 ea.



**Coil Bracket Screws**  
BAN-516 All ..... 1.95 pr.



**Carburetor Attaching Kits**  
BTE-1475 All Q-Jet ..... 8.95 ea.  
BMG-0095 All Holley ..... 5.99 ea.



**Clutch Pedal Booster Rod & Clip**  
For use with power disc brakes.  
FBC-799 Booster Rod Clip ..... 6.99 ea.  
FBC-606 Booster Rod Fork ..... 14.95 ea.



**Caliper Backing Plate Bolt**  
BCP-373 Plate to Spindle ..... 2.99 ea.



**Cylinder Head Bolts**  
NRM-1888 1965-72 BB (32 pc.) ..... 69.95 kit



**Control Arm Shims**  
DS-594 1/16" ..... 2.95 ea.  
DS-595 1/8" ..... 2.95 ea.

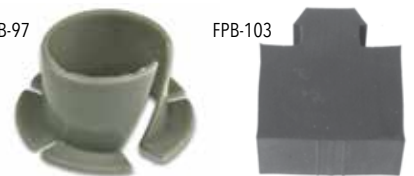

**Clutch Pedal Bushing & Bumper**  
Correct nylon bushing used for ease of pedal.  
FPB-97 All Bushing ..... 1.99 ea.  
FPB-103 All Bumper ..... 3.95 ea.



**Control Arm to Frame Bolts**  
4 serrated bolts and 4 locking nuts for one car.  
BPX-0918 1964-72 All ..... 18.99 kit





BPX-8542

### Control Arm Upper Washers

Complete kit to do one car.

BPX-8542 1964-72 All ..... 19.95 kit



BPB-1430

### Control Arm Bolts-Lower Front & Rear

BPB-1430 All ..... 7.99 ea.



BPC-7000

### Crossmember Bolts

BPC-7000 To Frame ..... 6.95 kit  
 BTE-7939 To Transmission ..... 0.95 ea.



LMC-3645

### Convertible Well Molding Clips

Complete set of correct well molding clips.

LMC-3650 1964-65 ..... 39.95 set  
 LMC-3645 1966-67 ..... 39.95 set  
 LMC-3640 1968-72 ..... 39.95 set



AX-907

### Cowl Hood Screen Screws

This is a set of 8 correct cowl hood screen attaching screws.

AX-907 1970-72 ..... 5.95 kit



MAP-64A

### Convertible Top Alignment Pin

Correct chrome alignment pin that mounts to the header bow to guide it in place to the windshield frame.

MAP-GUIDE-66 1966-67 Alignment Pin Guide ..... 21.95 pr.  
 MAP-64A 1968-72 Pin ..... 7.95 ea.



ACE-1400

### Distributor Hold Down

Correct retaining hardware for distributor.

ACE-1400 All ..... 4.95 kit



BPX-1275



BPX-1299

### Door Strikers w/ Washer

BPX-1275 GM Replacement ..... 9.99 ea.  
 BPX-1299 Reproduction\* ..... 11.99 ea.  
 BPX-1299K Reproduction Pair ..... 20.38 kit  
 \*Correct Allen Head Zinc Plated.



MS277-20M



### EMS Stainless Strikers

Replace your plain steel strikers with these attractive Eddie Motorsports Chevelle stainless steel door striker bolts. These billet striker bolts are cut with a Torx head and fit most Chevy muscle cars.

MS277-20M Machined ..... 47.99 pr.  
 MS277-20P Polished ..... 53.99 pr.



RBR-067

### Door Lock Rod Bellcrank Retainer Clip

Two required to mount one bellcrank to door frame.

RBR-067 1969-72 Chevelle ..... 5.99 ea.

IXP-18



### Door Panel Plugs

Correct plugs for attaching door panel clips. Buy the kit and save!

IXP-18K Plug Kit (12 pc.) ..... 19.10 kit  
 IXP-18 All Plug ..... 1.99 ea.



IDP-109

### Door Panel Screws

Correct size attaching screw for door panels.

IDP-109 All ..... 0.50 ea.



BAV-2622



RHS-9



BAV-2623

### Door Hinge Hardware

Correct OEM bolts and heavy spring.

BAV-2622 1964-67 Phillips ..... 1.99 ea.  
 BAV-2623 1964-72 Hex ..... 1.99 ea.  
 RHS-9 1964-72 Spring ..... 8.99 ea.  
 BAV-2622K Phillips (6) Hex (18) ..... 40.60 kit  
 BAV-2623K Hex (24) ..... 40.60 kit



BPX-1225

### Door Hinge Pin Kits

Correct hinge pins and brass bushings for repairing all 4 of your door hinges.

BPX-1225 1966-67 (12 pc.) ..... 14.95 ea.  
 BPX-2225 1968-72 (12 pc.) ..... 13.99 ea.

\*May require slight modification to hinges.



GDB-68-REG

### Door Track Hardware

This bolt kit is used to attach the window regulator, window tracks, door latch and other internal pieces to the door.

GDB-68-REG 1968-72 Small Washer (12 pc.) ..... 12.99 kit  
 GDB-68-REG-LRG 1968-72 Large Washer (8 pc.) ..... 16.99 kit

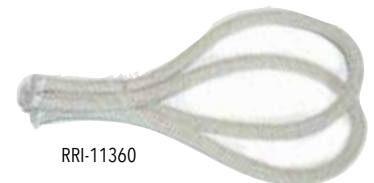

RR1-11360

### Door Rod Insulators

This is a set of two correct door lock rod insulator shields which protect the long door opening rods in the doors.

7.99 set 1964-72 ..... 7.99 set



RW-069-A

**Door Window Hardware Kit**

These convenient window hardware kits include all of the necessary parts to rebuild the rollers, guides and bushings on the quarter window regulators. Made in USA.

RW-069-A	1968-69 Door .....	56.95 kit
RW-070-A	1970-72 Door .....	36.95 kit
RW-066-A-REAR	1966-67 1/4 Window.....	59.95 kit
RW-069-A-REAR	1968-72 1/4 Window.....	59.95 kit



GGG-761

**Door Glass Guide Screws**

GGG-761	1968-72 (8 pc.).....	2.99 kit
---------	----------------------	----------



GGP-1485Y

**Door Glass Guide Plates**

Correct front door glass guide plates.

GGP-1485Y	1968-72 Felt Covered Steel .....	22.95 pr.
GGP-7072	1970-72 Plastic.....	8.99 ea.



GGF-557

**Door Glass Guide Felts**

GGF-557	(4 pc.).....	8.99 set
---------	--------------	----------



GGG-1485Q

**Door Glass Stabilizers**

Correct front door glass stabilizers.

GGG-1485Q	1970-72 .....	14.95 pr.
-----------	---------------	-----------



GCS-1485N

**Door Glass Support**

Correct front door glass support.

GCS-1485N	1970-72.....	11.95 ea.
-----------	--------------	-----------



GWR-15365

GWR-15366

**Door Glass Washers**

Plastic washer that is used to protect the door. Mounts between the glass and the metal fasteners within the door. 1.5 inch diameter.

GWR-15365	1964-77 w/ Step .....	3.99 ea.
GWR-15366	1964-77 .....	3.99 ea.



GDS-15231

GDS-1485P

**Door Glass Stopper**

Correct front door glass stopper.

GDS-15231	1968-72 .....	13.99 ea.
GDS-1485P	1970-72 .....	11.95 ea.



ALI-2228

**Exhaust Stud Kit**

Correct studs for mounting exhaust pipe to manifold. Our kit comes complete with 3 long & 3 short studs and 6 correct locking nuts.

ALI-2228	All SB - BB.....	24.99 kit
----------	------------------	-----------



APB-1382

**OEM Exhaust Manifold Bolts**

Correct head marked and colored bolts for mounting exhaust manifolds to block.

APB-1382	SB w/ Washers (24 pc.).....	27.99 kit
APB-1821	BB Flanged Head (16 pc.).....	23.99 kit
APB-3506	BB Loose Washer (32 pc.).....	26.99 kit



MS275-38

**EMS Stainless Hood Adjusters**

Eddie Motorsports stainless steel hood adjusters are machined completely from stainless steel. They will not rust or corrode. Sold individually.

MS275-38	Machined.....	28.99 ea.
MS275-38P	Polished.....	29.99 ea.



APC-0100

BPX-2792

**Fan and Shroud Attaching Kits**

Correct style bolts/studs for attaching fan to water pump.

BPX-2792	Attaching Stud Kit 12 Piece.....	6.95 kit
BPX-2791	Attaching Bolt Kit 8 Piece.....	5.95 kit
APC-0100	1968-72 All Lower Shroud Clips .....	2.95 pr.



BCI-4753

BPX-4755

**Fuel Tank Hardware**

Correct OEM bolts and clips.

BCI-4753	1964-67 All .....	8.95 kit
BPX-4755	1968-72 All .....	12.95 kit

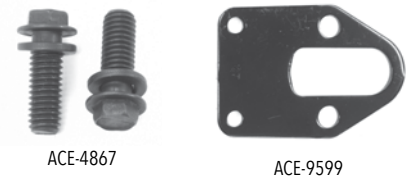

ACE-4867

ACE-9599

**Fuel Pump Hardware**

AJE-395	All Activating Rod .....	14.95 ea.
ACE-9599	All SB Plate.....	10.99 ea.
ACE-4867	Fuel Pump Bolts.....	7.95 kit

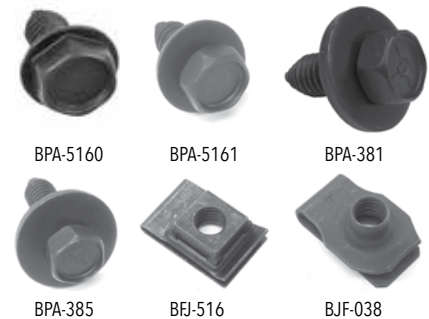

BPA-5160

BPA-5161

BPA-381

BPA-385

BFJ-516

BJF-038

**Fender Front End Bolts**

BPA-5160	5/16" Bolt w/o Washer .....	0.65 ea.
BPA-5161	5/16" Bolt w/ Washer.....	0.55 ea.
BPA-381	3/8" x 1" Bolt.....	0.65 ea.
BPA-385	3/8" x 1-1/2" Bolt .....	0.75 ea.
BFJ-516	Fender J Clip 5/16" .....	1.25 ea.
BJF-038	Fender J Clip 3/8" .....	1.50 ea.

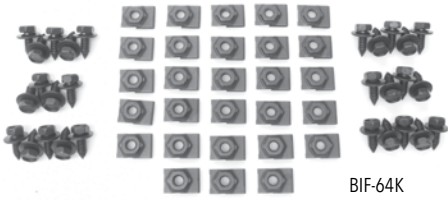

BIF-64K

**Fender Inner Bolt Kit**

BIF-64K 1964-72 All (56 pc.)\* ..... 26.95 ea.  
\*5/16" Bolts



EBB-691

**Flex Hose Bolts**

Correct OEM brake fluid bolt with hollow center and (2) special washers for attaching flex hose to caliper.

EBB-691 All w/ Disc Brakes ..... 3.99 ea.



GDS-707

**Front Door Glass Side Stop**

GDS-707 1970-72 ..... 13.99 ea.



GGP-706

**Front Door Glass Glide Plate**

GGP-706 1970-72 ..... 13.99 ea.



BCW-51

**Fender Cup Washers**

BCW-51 1964-72 All Zinc ..... 3.95 ea.



BPB-5116

**Flywheel Attaching Kit**

BPB-5116 1964-77 4 Speed ..... 14.99 kit  
BPB-5118 1964-77 Auto ..... 16.99 kit



APX-2339

**Frame Bracket Bolt Kit**

APX-2339 1964-88 To Frame ..... 6.95 kit



BAG-D2

**Grille Attaching Kits**

BAG-D1 1964-67 ..... 5.95 kit  
BAG-D2 1968-72 ..... 5.95 kit



BPB-5934

**Harmonic Balancer Bolt**

BPB-5933 All SB w/ Washer ..... 14.99 kit  
BPB-5934 All BB w/ Washer ..... 13.99 kit



LHS-64

LHS-70

**Headlamp Springs**

Correct spring used for proper adjustment.

LHS-64 1964-67 All ..... 2.99 ea.  
LHS-70 1968-70 All ..... 1.50 ea.  
LHS-71 1971-75 All ..... 2.95 ea.



LHA-64K

**Headlamp Adjustment Kit**

Plastic nuts and screws for headlamp adjustment. Each kit does one car.

LHA-64K 1964-70 All (8 pc.) ..... 7.95 kit  
LHA-73K 1971-72 All (4 pc.) ..... 5.95 kit  
LHA-789K 1978-79 (6 pc.) ..... 11.95 kit  
LHA-801K 1980-81 (6 pc.) ..... 17.95 kit  
LHA-827K 1982-87 (6 pc.) ..... 15.95 kit



RDR-72K

RDR-67

**Hinge Detent Rollers**

Correct machined detent rollers for lower hinges.

RDR-67 1965-67 All ..... 16.95 kit  
RDR-72K 1968-72 All ..... 26.99 kit

BCX-130

**Hood Valve Frame Screws**

This is a set of 6 correct screws to attach the hood valve frame.

BCX-130 1970-72 ..... 5.95 kit



BPQ-4011

**Hood Adjustment Bolts**

BPQ-4011 1964-72 All ..... 9.95 kit



BPQ-41-REAR

**Hood Stop Studs**

New hood stop studs that mount on cowl firewall. Special head with "C". 2 are used per car.

BPQ-41-REAR 1970-77 ..... 32.95 pr.



BPQ-BUMPER-REAR

**Hood Bumpers Rear**

These hard to find rubber hood bump stops are finally available! Sold in pairs they slide into a groove on both sides of the hood and rest on the cowl when the hood is closed to stop the hood from shaking.

BPQ-BUMPER-REAR 1968-72 ..... 4.95 pr.

BX-1070

**Hood Door Bracket Hardware**

Correct set of four screws for attaching bracket to hood.

BX-1070 1970-72 ..... 3.95 kit

BPA-381

**Hood Hinge Bolt**

BPA-381 3/8" x 1" ..... 0.65 ea.

ACL-5588

**Hood Door Attaching Kit**

Correct shouldered bolts with P head markings with nylon bushings.

ACL-5588 1970-72 ..... 8.95 kit





**BPS-3679 Intake Studs**  
 Correct intake manifold studs for various uses: alternator, solenoid and power brake tube. Includes correct nut.  
 BPS-3679 All 3/8" x 3/8" (Zinc)..... 6.99 ea.  
 (p.s. bracket, alternator mount, etc.)  
 BPS-7432 All 5/16" x 3/8" (Black)..... 3.95 ea.  
 (TCS, P.B. tube, etc.)



BPI-4400



BPI-2271

**Intake Manifold Kits**

BPI-4400 1967-72 SB "M" (12 pc.).....16.95 kit  
 BPI-9140 BB Cast "M" (16 pc.).....21.95 kit  
 BPI-2271 BB Alum. "A" (16 pc.).....25.99 kit



BPX-9873

**Idler Arm Bolts**

BPX-9873 To Frame.....3.95 pr.



BHE-1970

**Jack/Tire Retainer Kit**

BHE-1970 1964-72 All .....11.99 set



BPA-53K

**License Plate Attaching Kit**

BPA-53K All (4 pc.).....3.95 kit



APB-7057

**Motor Mount "Thru" Bolt Kit**

Correct OEM bolts for retaining mount to frame bracket. Comes complete with special high strength washers and cadmium plated locking nuts as original.

APB-9057 1964-67 All 4.5" .....8.95 kit  
 APB-7057 1968-72 All 3.5" .....6.95 kit



BJ-998

**Motor Mount Attaching Bolt Kit**

Correct style bolts for attaching mount to block

BJ-998 All (12 pc.).....8.95 kit



ATW-2853

**Motor Mount Clip**

Correct clip for attaching positive cable to right side motor mount.

ATW-2853 Most V8s ..... 19.95 ea.



MHQ-1234

**Mirror Mounting Kit**

Complete with bracket, gaskets, & screws.

MT-1820 1964-65 .....4.95 kit  
 MHQ-1234 1966-69 .....4.95 kit  
 MT-1970 1970-72 .....4.95 kit

Non-remote mirror.



BSL-516

**Nuts Self Locking**

BSL-516 5/16" Zinc..... 0.40 ea.  
 BSL-38 3/8" Zinc..... 0.50 ea.  
 BSL-716 7/16" Zinc..... 0.75 ea.  
 BSL-12 1/2" Zinc..... 0.95 ea.

BPO-1988

**Oil Drain Bolt w/ Washer**

BPO-1988 All ..... 6.95 ea.

BOP-2001



BOP-2002

**Oil Pan Attaching OEM Bolt Kit**

Correct "L" head marked bolts for attaching pan to block.

BOP-2001 All SB (18 pc.)..... 9.95 ea.  
 BOP-2002 All BB (24 pc.)..... 13.99 ea.

BFC-333

**Pulley Attaching Bolts**

BFC-333 All Fine (6 pc.) .....6.95 kit  
 BRB-100 All Coarse (6 pc.) .....6.95 kit



BSB-1970

**Power Steering Hardware Kits**

Our kits feature all correct hardware to attach power steering brackets to engine. A MUST!

CPZ-1513 1965-68 SS 396.....22.95 kit  
 BSB-69SB 1969-72 All SB.....11.99 kit  
 BSB-1969 1969 All BB .....17.99 kit  
 BSB-1970 1970-72 All BB.....12.95 kit

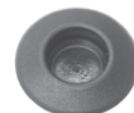

BPP-12



BPP-10



BPP-34

**Push-In Plugs**

BPP-12 1/2" Cowl Top, etc.....0.75 ea.  
 BPP-34 3/4" Wheelhouse ..... 1.00 ea.  
 BPP-10 1" Trunk Extension ..... 1.25 ea.  
 BPP-138 1-3/8" Rubber Plug..... 1.50 ea.



BPP-8386

### Pressure Plate Bolts

BPP-8386 All Manual (12 pc.).....9.99 kit



GTS-177

### Quarter Window Roller Tension Spring

This commonly missing spring is used to keep tension on the window roller so that the window goes up and down smoothly.

GTS-177 1968-72 ..... 5.95 ea.



GGG-15232

### Quarter Window Stop

Correct reproduction of the quarter window stop, with the correct plastic coated end and correct bolt hole as original.

GGG-15232 1968-72 ..... 12.99 ea.



GWR-060

### Quarter Window Roller Assembly

Complete window roller assembly for rear quarter including center lower guide roller and threaded stud assembly.

GWR-060 1968-72 All ..... 12.99 ea.



GWR-060A

### Quarter Window Roller Backing Washer

Correct backing washer for roller.

GWR-060A 1968-72 ..... 4.99 ea.



GWR-060B

### Quarter Window Roller Nylon Bushing

Correct nylon bushing for roller.

GWR-060B 1968-72 ..... 5.99 ea.



BPP-70Q

### Quarter Plug

Correct plug and orange gasket used to plug the rear quarter panel drain hole.

BPP-70Q 1970-72 ..... 20.99 pr.



BRE-2008

### Rear End Cover Bolt

BRE-2008 All Flanged..... 0.95 ea.



GGG-746

### Rear 1/4 Window Glass Side Stop

GGG-746 1968-72 ..... 15.99 ea.



GGP-707-REAR

### Rear Side Glass Glide Plate

GGP-707-REAR 1970-72 ..... 13.99 ea.



GDS-708

### Rear 1/4 Window Lower Stop

GDS-708 1970-72 ..... 13.95 ea.



BPP-084

### Rubber Body Plugs

Reproduction body plugs. GM licensed.

BPP-084 1964-72 1".....5.99 pr.

BPP-039 1968-69 (6 pc.).....13.99 kit



BSB-759

### Steering Box Bolt

BSB-759 All ..... 6.99 ea.



GCS-S0005

### Stainless Water Pump Bolts

Tapered head bolts used to mount the pulley to the water pump when using an electric cooling fan in place of a water pump mounted fan.

GCS-S0005 Bolts ..... 4.99 ea.



DSB-12959

### Rear Sway Bar Washers

Correct washers used on the nut side so that the nuts do not dig into the arms.

DSB-12959 1964-72 (4 pc.).....9.99 kit

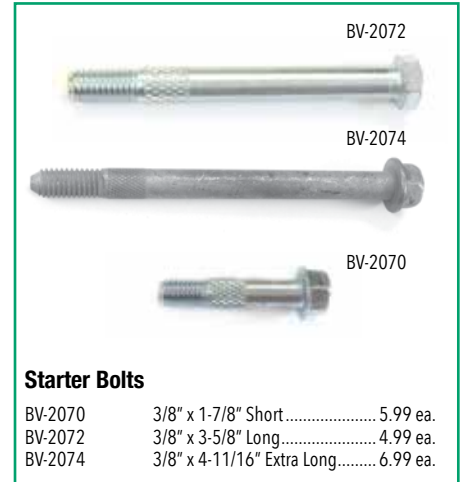

BV-2072

BV-2074

BV-2070

### Starter Bolts

BV-2070 3/8" x 1-7/8" Short ..... 5.99 ea.

BV-2072 3/8" x 3-5/8" Long..... 4.99 ea.

BV-2074 3/8" x 4-11/16" Extra Long..... 6.99 ea.



BPX-1950

### Sheet Metal Screw Kit

Over 20 pieces for small under hood items.

BPX-1950 All ..... 5.95 kit



BPX-9715



BPX-9715-REAR

### Shock Mounting Kit

Correct GM front shock mounting kit with (4) clips and (4) OEM bolts/washers.

BPX-9715 1964-88 All Front..... 6.95 kit

BPX-9715-REAR 1968-88 Rear Upper Shock

Mounting Hardware..... 8.95 kit



ATJ-411



**Steering Coupler Bolt**

Correct OEM style bolt for coupler.

ATJ-411 1964-76 All ..... 5.99 ea.

BAR-1295



**Sway Bar Bolt**

Correct mounting bolt for stock front sway bar.

BAR-1295 Correct Bolt ..... 0.75 ea.

FTH-049



**Shifter Cable Clip**

Correct push-on clip which mounts to shifter.

FTH-049 Push-on Clip (to shifter) ..... 7.99 ea.

EBC-22



**Shifter Cable Clip**

Correct clip for mounting cable.

EBC-22 Mounting Clip ..... 2.99 ea.

BSB-56



BSB-561



BSB-5-SBL



**Seat Belt Anchor Bolts**

BSB-56 All Front Outer ..... 7.95 ea.  
 BSB-56 1964-68 Front Inner ..... 7.95 ea.  
 BSB-561 1969-72 Front Inner ..... 7.95 ea.  
 BSB-561 All Rear ..... 7.95 ea.  
 BSB-5-SBL All Fully Threaded Shank ..... 7.95 ea.  
 1969-72 used (2) front seat belts.

BSM-5NT



BSM-516



**Seat Mounting Bolts**

BSM-516 All Front Bolts ..... 1.35 ea.  
 BSM-5NT All Rear Nuts ..... 1.35 ea.



BRS-12659

**Seat Back Release Screws**

Correct screws to hold the folding seat back assembly in the seat back.

BRS-12659 1969-72 (8 pc.) ..... 9.99 kit



KMC-15KWS

**Trim Stud Repair Kit OE GM**

OEM GM replacement trim studs for mounting front and rear window moldings and some rocker moldings. These studs come with a sealant to prevent corrosion.

KMC-15KWS 1967-88 All (8 pc) ..... 29.99 kit



JSB-E33

**Tailgate Bumpers**

Correct rubber stop bumpers which prevent the tailgate from hitting metal on metal.

JSB-E33 1968-72 El Camino ..... 2.95 ea.



RTG-647RB

**Tailgate Hinge Rebuild Kit**

Correct pins and bushings to make both tailgate hinges work like new. Original head markings and brass bushings to match originals.

RTG-647RB 1964-67 ..... 23.99 kit  
 RTG-682RB 1968-72 ..... 23.99 kit



RCK-E5

**Tailgate Cable Kit**

Complete kit with cables, springs and bolts.

RCK-E5 1968-77 El Camino ..... 36.99 set



RTH-E4817

**Tailgate Handle**

Reproduction inner tailgate handle with nylon washer.

RTH-E4817 1968-72 ..... 14.99 ea.



RGK-200

**Tailgate/Bed Fastener Kit**

Correct set of fasteners for tailgate and rear of bed.

RGK-200 1964-72 El Camino ..... 10.95 kit

RTS-1490E



**Tailgate Cable Springs**

Correct pair of tailgate cable springs.

RTS-1490E 1964-72 ..... 4.95 pr.  
 RTS-1490F 1973-77 ..... 4.95 pr.

RTH-1490H



**Tailgate Hinges**

Reproduction tailgate hinges to replace your worn out originals.

RTH-1490H 1968-72 ..... 169.95 pr.



INL-15190

**Top Cylinder To Frame Hardware**

This is a set of the correct bolts, bushings, washers and nuts to connect the convertible top cylinder to the top frame.

INL-15190 1968-72 ..... 24.99 ea.



ATR-2039

ATR-1039

### Thermostat Housing

ATR-1039	Most SB Bolt/Stud.....	8.99 ea.
ATR-2039	All SB-BB Bolt.....	7.95 ea.
ATR-3039	1967-68 Gooseneck.....	8.99 kit



BTE-307

BTE-7939

### Transmission Mounting Hardware

BTE-307	To Bellhousing (8 pc.).....	8.95 kit
BTE-7939	To Rear Mount.....	0.95 ea.



BTC-650

### Timing Cover Bolt Kit

BTC-650	"L" Sems Bolts.....	8.95 kit
---------	---------------------	----------



APB-1023

### Valve Cover Bolts

APB-1023	SB "TR" (16 pc.).....	14.95 kit
APB-2023	BB "TR" (28 pc.).....	23.95 kit
APB-1027	SB "M" (8 pc.).....	16.99 kit

M bolts were used on finned aluminum valve covers.



AVX-515

### Voltage Regulator Nuts and Screws

AVX-515	1968-71 All.....	0.95 kit
---------	------------------	----------



ATR-3232

ATR-4334



AWS-301S

### Water Pump OEM Attaching Bolt Kits

Correct style attaching bolts with "TR" head markings.

ATR-3232	1964-68 2 Bolts 2 Stud.....	8.99 kit
ATR-4334	1969-72 All 4 Bolts M Mark.....	10.99 kit
AWS-301S	Stud Only (Short).....	2.99 ea.



APX-1400



ATE-5695

APJ-2153



### Wing Nuts, Flame Arrester & Studs

APX-1400	Chrome Wing Nut.....	4.95 ea.
APX-7700	Black Wing Nut.....	4.95 ea.
ATE-5695	Flame Arrester.....	8.95 ea.

### Carburetor Studs

APJ-2153	All w/ Holley Open Element	
	1-1/2" Long.....	12.95 ea.
AP-315	All w/ Q-Jet 3-3/8" Long.....	12.95 ea.
AP-315	1970-72 Holley w/ Cowl Induction.....	12.95 ea.
AP-317	1970-72 Q-Jet w/ Cowl Induction 5-3/16" Long.....	13.95 ea.
ATE-5256	Universal w/ Point End 4-1/4" Long.....	8.95 ea.



TRIM-WR

### Window Roller Tool

Allows you to easily install window rollers.

TRIM-WR	All.....	14.95 ea.
---------	----------	-----------



GWR-12660

### Window Retainers

Two piece window glass retainer used to hold the side window glass to the regulator.

GWR-12660	1968-72.....	6.99 pr.
GWR-15365	1964-77 Plastic Washer Only.....	3.99 ea.



WR-344



WR-068



WR-76



WR-78

### Window Rollers

Correct replacement window rollers.

WR-344	1964-65 Lower Rear 1/4.....	8.95 ea.
WR-068	1964-65 Door.....	8.99 ea.
WR-343	1966-67 1/4 Window.....	8.95 ea.
WR-76	1968-72 Lower Rear 1/4.....	8.95 ea.
WR-78	1969-72 Door.....	12.95 ea.
WR-065	1968-72 Lower Rear 1/4.....	8.95 ea.

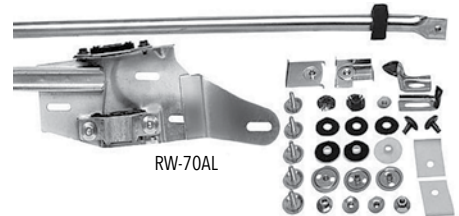

RW-70AL

### Window Track And Hardware Kits

This convenient door window track & hardware kit is great for when you are changing out your door glass.

RW-70AL	1970-72 Chevelle LH.....	195.95 set
RW-70AR	1970-72 Chevelle RH.....	195.95 set

*Ships Oversize. No Volume Discount.*



LTR-CLIP

### 1966 Chevelle Bezel Clips

Correct kit for retaining tail light bezels to car.

LTR-CLIP	1966 Chevelle.....	11.95 set
----------	--------------------	-----------