

Fenders

Our reproduction fenders are manufactured to duplicate the originals in both fit and appearance. All fenders come EDP coated. Just as with original GM fenders, we recommend test fitting before painting.

No Volume Discount. All fenders ship Truck Freight to a commercial address. 

RF-67SL

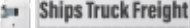

- RF-67SL 1967 Standard LH..... 219.95 ea.
- RF-67SR 1967 Standard RH..... 219.95 ea.
- RF-67RL 1967 Rally Sport LH..... 219.95 ea.
- RF-67RR 1967 Rally Sport RH..... 219.95 ea.

RF-68RL



- RF-68SL 1968 Standard LH..... 195.95 ea.
- RF-68SR 1968 Standard RH..... 195.95 ea.
- RF-68RL 1968 Rally Sport LH..... 195.95 ea.
- RF-68RR 1968 Rally Sport RH..... 195.95 ea.

RF-69RL



- RF-69RL 1969 All LH..... 199.95 ea.
- RF-69RR 1969 All RH..... 199.95 ea.

All fenders include a Rally Sport bracket which can be removed for standard models.

RF-70L



- RF-70L 1970-77 All LH..... 184.95 ea.
- RF-70R 1970-77 All RH..... 184.95 ea.



RF-781L

- RF-781L 1978-81 w/o Z/28 LH..... 169.95 ea.
- RF-781R 1978-81 w/o Z/28 RH..... 169.95 ea.



RF-781ZL

- RF-781ZL 1978-81 Z/28 LH..... 169.95 ea.
- RF-781ZR 1978-81 Z/28 RH..... 169.95 ea.



RF-8290L

- RF-8290L 1982-90 Z/28 LH..... 119.95 ea.
- RF-8290R 1982-90 Z/28 RH..... 119.95 ea.



RF-9192L

- RF-9192L 1991-92 Z/28 LH..... 99.95 ea.
- RF-9192R 1991-92 Z/28 RH..... 99.95 ea.



RF-67XL



RF-69XL



RF-67XR



RF-69XR



Lower Fender Extensions

OE style reproduction fender extensions which fill the area between the lower valance panel and the fender.

RF-67XL	1967-68 LH	29.95 ea.
RF-67XR	1967-68 RH	29.95 ea.
RF-69XL	1969 LH	29.95 ea.
RF-69XR	1969 RH	29.95 ea.
RF-78XL	1978-81 LH w/o Spoiler Holes*	79.95 ea.
RF-78XR	1978-81 RH w/o Spoiler Holes*	79.95 ea.

*Must Drill Holes For Spoiler



RFP-69L

Fender Patches

High quality fender patches for this commonly rusted area.

RFP-678L	1967-68 LH	69.99 ea.
RFP-678R	1967-68 RH	69.99 ea.
RFP-69L	1969 LH w/ Brace	54.95 ea.
RFP-69R	1969 RH w/ Brace	54.95 ea.
RFP-781L	1970-81 LH	29.95 ea.
RFP-781R	1970-81 RH	29.95 ea.



RFB-1038R

RFB-1038G

Inner Fender Well Braces

Correct steel curved braces that attach to the rear of the inner fender well to the firewall.

RFB-1038R	1967-69 RH	19.95 ea.
RFB-1038L	1967-69 LH	19.95 ea.
RFB-1038K	1967-69 LH/RH Pair	35.91 kit
RFB-1038G	1970-73 RH	26.95 ea.
RFB-1038H	1970-73 LH	26.95 ea.



BFE-9001

Front End Fastener Kit

Over 175 pieces all individually bagged to attach all of your front end sheet metal including fenders, grille, inner fenders, hood, etc.

BFE-9001	1967-68 All	45.95 kit
BFE-9002	1969 All	45.95 kit
BFE-9003	1970-81 All	45.95 kit



RFB-656

Fender Support Bars

These OE style reproduction fender support bars extend from the side of the fenders to the top of the radiator support. Finished in your choice of black or chrome.

RFB-656	1967-69 Black	16.99 pr.
RFB-653	1967-69 Chrome	18.99 pr.
RFB-7081B	1970-81 Black	18.95 pr.
RFB-7081C	1970-81 Chrome	18.95 pr.



RIF-678L

BUY 'N SAVE WITH KITS

Front Inner Fenders

Brand new die-stamped inner fender wells. Buy the pair and save.

RIF-678L	1967-68 LH	89.95 ea.
RIF-678R	1967-68 RH	89.95 ea.
RIF-678K	1967-68 LH/RH	186.17 kit
RIF-68RS-L	1968 RS LH	119.95 ea.
RIF-68RS-R	1968 RS RH	119.95 ea.
RIF-69FL	1969 LH	89.95 ea.
RIF-69FR	1969 RH	89.95 ea.
RIF-69FK	1969 LH/RH	186.17 kit
RIF-69RS-L	1969 RS LH	119.95 ea.
RIF-69RS-R	1969 RS RH	119.95 ea.
RIF-70FL	1970-81 LH	99.95 ea.
RIF-70FR	1970-81 RH	99.95 ea.
RIF-70FK	1970-81 LH/RH	179.91 kit

Ships Oversize 2.



RRS-070R

Radiator Support

Excellent quality reproduction radiator support. Black EDP coated.

RRS-067R	1967-69 All	79.95 ea.
RRS-070R	1970-73 All	121.99 ea.
RRS-77	1974-77	349.99 ea.
RRS-781	1978-81	369.95 ea.

No Volume Discount. Ships Oversize 2.



DRS-67H

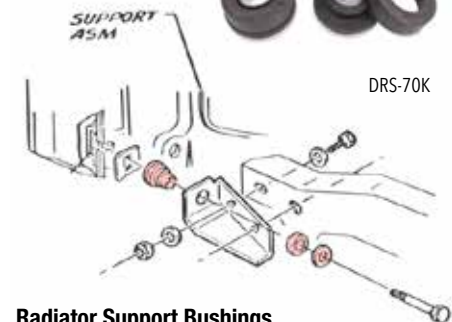

DRS-70K

Radiator Support Bushings

Complete kit with all bushings and hardware for mounting radiator support to car.

DRS-67H	1967-81 All	21.52 kit
DRS-70K	1970-73 Side Bushings*	26.99 kit
RRS-070-SB	1970-73 Brackets	42.99 pr.

*Does not fasten to frame and does not include hardware

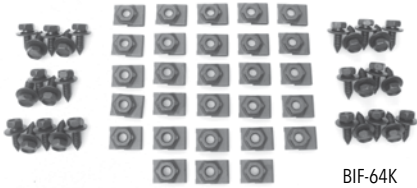

BIF-64K

Fender Inner Bolt Kit To Fender

BIF-64K All 56pc.....26.95 ea.



BCW-51

Fender Cup Washers

BCW-51 All Zinc3.95 ea.



CA109

A-Arm Dust Shields

Correct die stamped material that seals the engine compartment. Mounts to inner fender wells, complete with staples.

CA109	1967-68 Complete 5pc.....	21.99 kit
CA110	1969 Complete 5pc.....	21.99 kit
JHC-105	1967-68 A-Arms Only	13.99 pr.
JHC-106	1969 A-Arms Only.....	11.99 pr.
JHC-110	1970-81 A-Arms Only	11.99 pr.
JHC-108	1967-69 Fender/Cowl.....	5.99 ea.
JHC-107	1967-69 Frame.....	8.99 pr.



4022-150-82

1982-92 Upper Fender Tie Bar

4022-150-82 All.....54.95 ea.
Ships Oversize 2.



RFL-7878

1978-81 Fender Louvers

High quality fender vent louvers for Z/28 models. Manufactured in die-cast zinc, paint to match.

RFL-78K	1978-79.....	236.99 pr.
RFL-7878	1978-79 Mounting Hardware.....	79.99 pr.
RFL-80K	1980-81.....	290.99 pr.
RFL-8080	1980-81 Mounting Hardware.....	69.99 pr.

AMK inc
PRODUCTS



Detail shot of a 1968 Camaro Master Body Hardware kit. These kits have all of the hard to find items that are not available anywhere else!

What Your Body Needs!

AMK Products

Master Body Kit

Master body kits contain just about every piece of hardware to assemble the body of your Camaro. Each kit contains hardware for your battery tray, bumpers, filler panel, filler panel moldings, bumper brackets, cowl vent panel, door latches, emblems, fender braces, fenders, front tie bar, grille, grille brackets, grille moldings, headlamps, headlamp bezels, hood, hood hinges, hood latch, hood latch support, license plate, mirrors, parking lamps, tail lamps, trunk latch, trunk lid hinges, wheel opening moldings, wheelhouses, radiator support and more! This kit truly has it all!

67FB-S	1967 Standard	223.99 kit
67FB-RS	1967 Rally Sport.....	222.99 kit
68FB-S	1968 Standard	223.99 kit
68FB-RS	1968 Rally Sport.....	223.99 kit
69FB-S	1969 Standard	223.99 kit
69FB-RS	1969 Rally Sport.....	221.99 kit
70FB-S	1970-72 Standard	222.99 kit
70FB-RS	1970-72 Rally Sport	219.99 kit
73FB-S	1973 Standard	231.99 kit
73FB-RS	1973 Rally Sport.....	219.99 kit
74FB	1974-76 All.....	249.99 kit
77FB	1977 All.....	284.99 kit
78FB	1978 All.....	304.99 kit
79FB	1979 All.....	259.99 kit
80FB	1980-81 All.....	270.99 kit

No Volume Discount.



Style 1 in Black Anodized ACG-67F1B



Style 2 in Black Anodized ACG-67F2B

Cowl Hood Grilles

If you're tired of looking at the hole in the back side of your cowl hood, this 1967-69 Camaro cowl hood grille is the answer. Constructed of 16 gauge aluminum, this cowl hood grille will keep things looking neat while keeping out debris.

ACG-67F1C	1967-69 Style 1 Clear Anodized	41.99 ea.
ACG-67F1B	1967-69 Style 1 Black Anodized	41.99 ea.
ACG-67F1P	1967-69 Style 1 Polished.....	41.99 ea.
ACG-67F2C	1967-69 Style 2 Clear Anodized	41.99 ea.
ACG-67F2B	1967-69 Style 2 Black Anodized	41.99 ea.
ACG-67F2P	1967-69 Style 2 Polished.....	41.99 ea.



TM-30040

ProStyle Cowl Induction Trim Plates

Dress up the unsightly hole in the back of the hood with a ProStyle cowl induction trim plate from Twist Machine. Airflow is not restricted. Includes stainless steel hardware.

TM-30045	1967-69 Brushed (GM Hood).....	72.95 ea.
TM-30145	1967-69 Black (GM Hood).....	82.95 ea.



DSE011801

Detroit Speed Fender Brace Kit

This new DSE Camaro fender brace kit is another way to beautify your engine compartment. The fender braces are 100 percent CNC machined Clevis' from 304 stainless steel. The kit includes fabricated mounting brackets and comes with button head stainless steel mounting bolts. The fender braces triangulate the radiator core support to the fender and are fully adjustable (a benefit not available with your stock fender braces). All mounting brackets come powdercoated satin black.

DSE011801	1967-69 All.....	208.99 kit
DSE011802	1970-81 All.....	208.99 kit

No Volume Discount

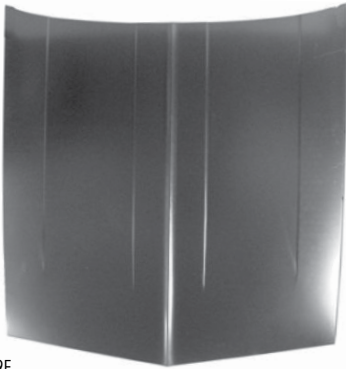

RH-69F

1967-69 Standard Hood

OE style reproduction standard flat hood, perfect for an original restoration.

RH-69F 1967-69 All 239.95 ea.
No Volume Discount. Ships Truck Freight.

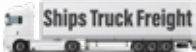

RH-6955

1967-69 Super Sport Hood

OE style reproduction steel Super Sport hood.

RH-6955 1967-69 SS 239.95 ea.
RH-69SSK 1968-69 SS w/ Hood Louvers 350.95 kit
No Volume Discount. Ships Truck Freight.

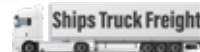

RH-6795

1967-69 Stinger Style Steel Hood

Give your Camaro that big block look with this steel stinger hood similar to the hood equipped on 1967 big block Corvettes and Yenko Camaros. Works with your factory hood hinges.

RH-6795 1967-69 All 439.95 ea.
No Volume Discount. Ships Truck Freight.

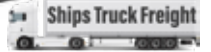

RH-69R

1967-69 Cowl Induction Hood

Add some muscle to your standard Camaro or replace your original cowl induction hood with this OE style reproduction. This is a factory style steel cowl induction hood.

RH-69R 1967-69 199.95 ea.
No Volume Discount. Ships Truck Freight.

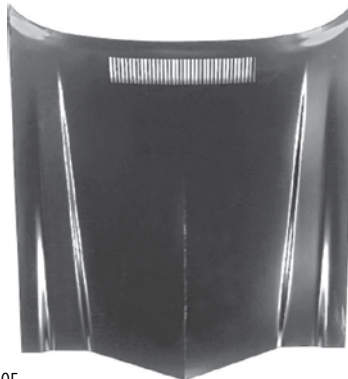

RH-70F

1970-81 Standard Hood

OE style reproduction standard flat hood, perfect for an original restoration.

RH-70F 1970-81 All 369.95 ea.
No Volume Discount. Ships Truck Freight.

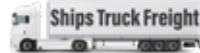

RH-679L88

1967-69 L88 Style Steel Hood

Give your Camaro that big block look with this steel stinger hood similar to the hood equipped on 1967-69 L88 Corvettes. Works with your factory hood hinges.

RH-679L88 1967-69 All 419.95 ea.
No Volume Discount. Ships Truck Freight.

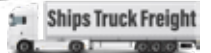

RH-69RS

1967-69 4" Cowl Hood

Let people know that your Camaro means business with this massive 4" steel cowl induction hood. This is not a cheap fiberglass hood. It can be used with your factory hinges and hood latch and is perfect for tall air cleaners or when you want that serious muscle car look.

RH-69RS 1967-69 All 289.95 ea.
No Volume Discount. Ships Truck Freight.

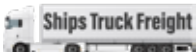

RH-78CI

1970-81 Cowl Induction Hood

This is the hood that GM should have made from the factory! Add some muscle to your Camaro with this 2" cowl hood. This hood is perfect for street machines and will really give your ride the ultimate muscle car look!

RH-78CI 1970-81 All 319.95 ea.
No Volume Discount. Ships Truck Freight.

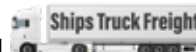

RH-82-4

1982-92 Cowl Hood

Give your Camaro that performance look with one of these cowl hoods. Available in 2" and 4" .

RH-82-2 1982-92 2" 319.95 ea.
RH-82-4 1982-92 4" 319.95 ea.
No volume discount. Ships Truck Freight.

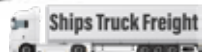

Eddie Motorsports Billet Hood Hinges

This is a set of awesome Eddie Motorsports billet Camaro hood hinges complete with hardware. These hinges feature modern style struts so no springs or props are required.
R=Red, B=Blue, W=White,



Steel 1967-69	
MS149-50BKA	Black Anodized 690.99 pr.
MS149-50BK	Gloss Black..... 635.99 pr.
MS149-50CA	Clear Anodized 690.99 pr.
MS149-50_	Specify Color..... 690.99 pr.
MS149-50CL	Clear Coat 690.99 pr.

Fiberglass 1967-69	
MS149-50FBA	Black Anodized 690.99 pr.
MS149-50FBK	Gloss Black..... 635.99 pr.
MS149-50FCA	Clear Anodized 690.99 pr.
MS149-50F_	Specify Color..... 690.99 pr.
MS149-50FCL	Clear Coat 690.99 pr.
MS149-50FMB	Machined 580.99 pr.
MS149-50FBMB	Matte Black..... 635.99 pr.
MS149-50FP	Polished..... 635.99 pr.

Steel 1970-81	
MS149-52BKA	Black Anodized 745.99 pr.
MS149-52BK	Gloss Black..... 695.99 pr.
MS149-52CA	Clear Anodized 745.99 pr.
MS149-52_	Specify Color..... 745.99 pr.
MS149-52CL	Clear Coat 745.99 pr.
MS149-52M	Machined 640.99 pr.

Fiberglass 1970-81	
MS149-52FBA	Black Anodized 745.99 pr.
MS149-52FBK	Gloss Black..... 695.99 pr.
MS149-52FCA	Clear Anodized 745.99 pr.
MS149-52F_	Specify Color..... 745.99 pr.
MS149-52FCL	Clear Coat 745.99 pr.
MS149-52FMB	Machined 640.99 pr.
MS149-52FBMB	Matte Black..... 695.99 pr.
MS149-52FP	Polished..... 695.99 pr.



Hood Hinges

Your choice of high quality, OE style reproduction hood hinges or GM licensed hinges.

GM Licensed	
RHG-667L	1967-69 LH 119.99 ea.
RHG-667R	1967-69 RH 119.99 ea.

Reproduction	
RHG-142L	1967-69 LH 39.95 ea.
RHG-142R	1967-69 RH 39.95 ea.
RHG-142K	1967-69 w/ Bolts..... 68.08 kit
RHG-129L	1970-81 LH 54.95 ea.
RHG-129R	1970-81 RH 54.95 ea.
RHG-129K	1970-81 w/ Bolts..... 86.33 kit

Universal Chrome Hood Pin Kits Peel N Stick



These hood pin kits are a great way to add that pro-touring/ racing looks without drilling or cutting your hood. The pin mounts are either chrome plated or black aluminum with chrome pins and feature rubber coated cables. They attach with high quality double sided 3M adhesive tape.

HPK-BC	Chrome All 29.99 kit
HPK-BB	Black All..... 26.99 kit



Chrome Hood Hinges

OE style chrome plated hood hinges stamped from high strength steel.

RHG-955	1967-69 All 360.99 pr.
---------	------------------------------



Billet Hood Hinges

Give your engine bay a custom touch with these affordable billet hood hinges! These hood hinges come complete with heavy duty struts and hardware.

RHG-BH11	1967-69 All 499.95 kit
----------	------------------------------

No volume Discount.



Assembled Hood Hinges

These are OE style reproduction hood hinges which will replace your originals perfectly. These hinges include a pre-installed spring which makes installation a snap.

RHG-142WSL	1967-69 LH All 49.95 ea.
RHG-142WSR	1967-69 RH All 49.95 ea.
RHG-142WSK	1967-69 Pair All 89.91 ea.

Hood Catch

Correct catch which mounts on underside of hood. Chrome or black.

RC-661	1967-81 Black..... 20.99 ea.
GCS-S9473	1967-81 Chrome 16.79 kit



1967-81 Billet Hood Latch Assembly

M = Machined, P = Polished, CL = Clear Coat, BKA = Gloss Black Anodized, CA = Clear Anodized, BK = Gloss Black Finish, MBA = Matte Black Finish

	M	P	All Others
MS276-10_	126.99 ea.	149.99 ea.	175.95 ea.



Hood Latch Support

Correct hood latch support which mounts vertically between the grille and the radiator support.

RLS-225	1967-68 All 22.95 ea.
RLS-220	1969 All 22.95 ea.
RLS-1068NA	1970-73 All 29.95 ea.
RLS-369	1978-81 LH 49.99 ea.
RLS-477	1974-81 RH 54.99 ea.



Hood Hinge Spring

Brand new GM hood springs.

RHS-25	1967-69 Std/Cowl Ind..... 15.95 ea.
RHS-272	1967-69 SS 15.95 ea.
RHS-272	1970-81 All 15.95 ea.



Hood Adjustment Bolts

BPQ-4011	1967-69 9.95 kit
BPQ-4011-70-REAR	1970-81 Rear 15.99 pr.
BPQ-4011-CNTR	1970-81 Rear Center..... 17.99 kit
BCB-12955	1970-81 On Hood Bumper..... 18.95 pr.

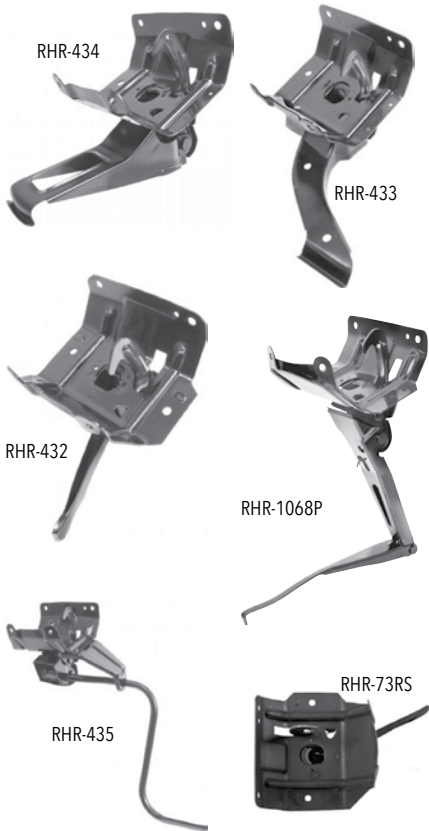

Hood Latches

OE style reproduction hood release assemblies.

RHR-434	1967 Std	59.95 ea.
RHR-433	1968 Std	59.95 ea.
RHR-435	1967-68 RS	59.95 ea.
RHR-432	1969 All	59.95 ea.
RHL-1068P	1970-73 Std	79.95 ea.
RHR-73RS	1970-73 RS	89.99 ea.

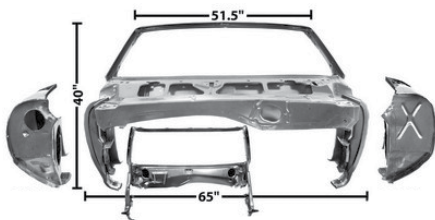

RWC-1073G

1969 Convertible Windshield and Cowl Assembly

This is a complete replacement windshield and cowl assembly area. This massive piece is designed to replace all of this commonly rotted out area on your convertible. This assembly includes the complete cowl area with shoulders and windshield frame.

RWC-1073G 1969 Convertible..... 1039.95 ea.
 Note: Will NOT fit coupe.
 Ships Truck Freight to a commercial address.
 No Volume Discount.



Front Lower Valance Panel

OE style reproduction steel valance panels ready to prep and paint.

RVP-567	1967-68 Standard.....	54.95 ea.
RVP-671	1967 Rally Sport	54.95 ea.
RVP-681	1968 Rally Sport	54.95 ea.
RVP-686	1969 All	59.99 ea.
RVP-544	1970-73 Standard.....	189.95 ea.
RVP-7Z	1970-73 Rally Sport.....	255.99 ea.

Ships Oversize. No Volume Discount.



1970-73 Bumper Filler Panels

Die stamped heavy gauge steel panels to replace the often corroded or missing originals. Fits standard or Rally Sport.

RBF-596	1970-73 All	59.99 pr.
---------	-------------------	-----------



1970-81 Cowl Vent Screen

A high quality reproduction of the plastic screen that keeps debris out of the cowl.

KVS-774	All	59.99 ea.
BPX-7V	Screws	5.95 kit

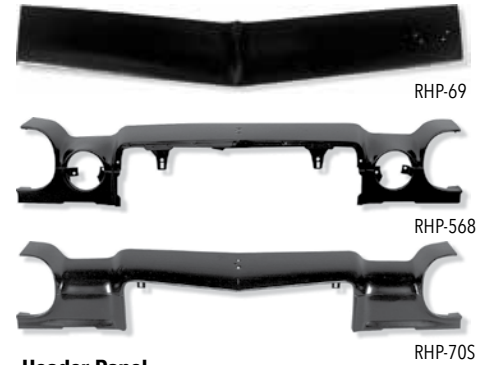

Header Panel

OE style reproduction steel panel which installs directly in front of the hood.

RHP-678	1967-68 All	54.95 ea.
RHP-69	1969 All	59.95 ea.
RHP-568	1970-73 Rally Sport.....	209.95 ea.
RHP-70S	1970-73 Standard.....	179.99 ea.

Ships Oversize. No Volume Discount.



RDP-70



BPX-9V

Cowl Vent Panel

Louvered sheet metal piece which installs directly below the windshield and behind the hood.

RCP-610R	1967-69	95.95 ea.
RDP-70	1970-73	169.95 ea.
BPX-9V	1967-69 Vent Panel Screws	6.95 kit

Ships Oversize. No Volume Discount.

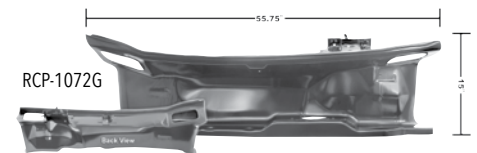

RCP-1072G

1970-73 Lower Cowl Panel Valley

This is an OE style reproduction lower cowl panel valley assembly which will replace this often rotted out area on your Camaro.

RCP-1072G	1970-73	289.95 ea.
-----------	---------------	------------

Ships Oversize 2. No Volume Discount



RDP-439

Dash Top Panel

Correct reproduction of the inner metal dash panel assembly. Extends from the windshield area to the instrument panel assembly where the dash pad mounts. Welding is required when installing this panel.

RDP-437	1967 All	69.95 ea.
RDP-437-A	1967 All OE style*	99.95 ea.
RDP-438	1968 All	69.95 ea.
RDP-438-A	1968 All OE style*	99.95 ea.
RDP-439	1969 All	69.95 ea.
RDP-439-A	1969 All OE style*	99.95 ea.

Ships Oversize. No Volume Discount.

*Adds additional coverage.



RDP-1068EA

Complete Dash Panel

This long awaited dash panel comes fully assembled and ready to install. This is the same piece that is currently being used on the Dynacorn complete Camaro bodies.

RDP-1068CA	1967 w/ AC	289.95 ea.
RDP-672C	1967 w/o AC	259.95 ea.
RDP-1068DA	1968 All	289.95 ea.
RDP-1068EA	1969 All	289.95 ea.

Ships Oversize. No Volume Discount.



RCP-1072B

Top Inner Cowl Panel

This top of cowl assembly features a complete panel with wiper valley all in a sealed unit. A great item to repair your original rusted out piece.

RCP-1072	1967 w/ AC Only	299.95 ea.
RCP-1072A	1968 All	299.95 ea.
RCP-1072B	1969 All	299.95 ea.

Ships Oversize. No Volume Discount.



Upper Inner Cowl Panel

RCP-67UP-AC

The perfect replacement for this commonly rotted out area.

RCP-67UP-AC	1967 w/ A/C	174.95 ea.
RCP-689UP	1968-69 w/o A/C	180.95 ea.
RCP-689UP-AC	1968-69 w/ A/C	180.95 ea.

Ships Oversize. No Volume Discount.



RFB-1046S

Firewall Brackets

OE style reproduction of the often rotted firewall brackets which provide the mounting points for the body mounts.

RFB-67FL	1967-69 LH	69.95 ea.
RFB-67FR	1967-69 RH	69.95 ea.
RFB-1046S	1970-73 All	129.95 pr.



RFW-1046D

Firewalls

Brand new complete firewalls.

RFW-1046F	1967 Heater Delete	269.95 ea.
RFW-1046Q	1967 w/ Heater	269.95 ea.
RFW-1046D	1967 w/ Air Conditioning	269.95 ea.
RFW-1046H	1968-69 Heater Delete	249.95 ea.
RFW-1046G	1968-69 w/ Heater	269.95 ea.
RFW-1046I	1968-69 w/ Air Conditioning	269.95 ea.
RFW-1046R	1970-73 w/ Heater (w/ brackets)	369.95 ea.

Ships Truck Freight to a commercial address. No Volume Discount.



RFC-1046GA

Custom Firewall Cover

This weld on cover, covers up the holes in the firewall leaving you with a smooth, custom firewall that is great for your show car or custom Camaro.

RFC-1046GA	1968-69	299.95 ea.
------------	---------	------------

Ships Oversize. No Volume Discount.



RFB-1046L

RFB-1046M

1969 Firewall to Floor Pan Braces

These steel pieces extend from the firewall down to the floor cross brace.

RFB-1046L	1969 RH	49.95 ea.
RFB-1046M	1969 LH	49.95 ea.



RD-67

Dash Panel Face

Great piece for replacing your original rusted dash.

RD-67	1967 w/o AC	239.95 ea.
RD-67AC	1967 w/ AC	239.95 ea.
RD-68	1968 w/o AC	239.95 ea.

Ships Oversize. No Volume Discount.



IDH-181

Door Mounting Hardware Kit

Correct Camaro door hardware for mounting door opening mechanism, door latch, window tracks, upper glass sash, inner sash and door opening rod guide bracket. One kit required per door.

IDH-181	1967 All 20pc	16.99 kit
IDH-182	1968-69 All 27pc	19.99 kit
IDH-183	1980-81 All 27pc	21.99 kit

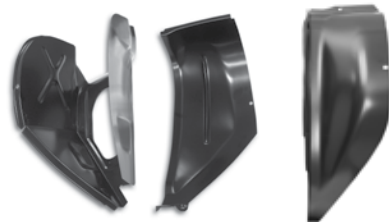

RCP-1073L

RCP-7073R

Lower Cowl Panel Shoulder Assembly

Our complete 1967-69 assembly will replace your rotted out factory originals. This is a complete replacement panel and features all correct cowl openings and ducting.

RCP-1073L	1967-69 LH	89.95 ea.
RCP-1073R	1967-69 RH	89.95 ea.
RCP-7073L	1970-81 LH*	59.95 ea.
RCP-7073R	1970-81 RH*	59.95 ea.
RCP-679L	1967-69 LH*	44.95 ea.
RCP-679R	1967-69 RH*	44.95 ea.
RCP-679K	1967-69 LH/RH* Pair	80.91 kit

*Outer Skin Only.



RSH-67FL

Door Shells

These full door shells feature the outer skin welded to the shell as original. These complete doors are perfect when original doors are rotted all the way through.

RSH-67FL	1967 All LH	289.95 ea.
RSH-67FR	1967 All RH	289.95 ea.
RSH-68FL	1968 All LH	289.95 ea.
RSH-68FR	1968 All RH	289.95 ea.
RSH-1076DX	1968 LH Smooth (No Holes)	349.95 ea.
RSH-1076CX	1968 RH Smooth (No Holes)	349.95 ea.
RSH-69FL	1969 All LH	299.95 ea.
RSH-69FR	1969 All RH	299.95 ea.
RSH-1076FY	1969 LH Smooth (No Holes)	349.95 ea.
RSH-1076EY	1969 RH Smooth (No Holes)	349.95 ea.
RSH-74FL	1970-74 All LH	569.95 ea.
RSH-74FR	1970-74 All RH	569.95 ea.
RSH-75L	1975-81 All LH	599.95 ea.
RSH-75R	1975-81 All RH	599.95 ea.

Ships Truck Freight to a commercial address.



RDS-67FL

Door Skins

Die stamped steel door skins are perfect when your inner door structures are in good shape. These skins weld over your existing inner door.

RDS-67FL	1967 All LH	95.95 ea.
RDS-67FR	1967 All RH	95.95 ea.
RDS-68FL	1968 All LH	95.95 ea.
RDS-68FR	1968 All RH	95.95 ea.
RDS-69FL	1969 All LH	95.95 ea.
RDS-69FR	1969 All RH	95.95 ea.
RDS-70FL	1970-81 All LH	84.95 ea.
RDS-70FR	1970-81 All RH	84.95 ea.
RDB-70FL	1970-81 LH Door Inner Frame Bottom*	129.99 ea.
RDB-70FR	1970-81 RH Door Inner Frame Bottom*	129.99 ea.

* Works with outer skin to repair your factory door shell. Ships Oversize 2.

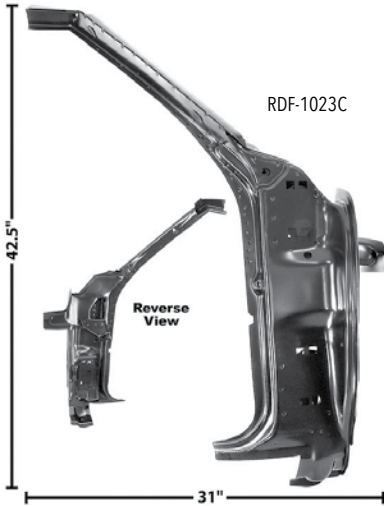

RDF-1023C

Door Inner Frame A-Pillars

OE style reproduction inner door frame and A-pillar assembly. Parts of this area (especially the door hinge mounting locations) are commonly rotted out on Camaros. Complete replacement.

RDF-1021D	1967 LH	319.95 ea.
RDF-1021C	1967 RH	319.95 ea.
RDF-1023H	1968 LH	335.95 ea.
RDF-1023G	1968 RH	335.95 ea.
RDF-1023D	1969 LH	335.95 ea.
RDF-1023C	1969 RH	335.95 ea.

Upsize 2



REG-67FL



REG-68FXL

REG-67FRL



REG-71FR

Window Regulators

OE style reproduction window regulators complete and ready to install. Available for standard and deluxe interiors.

Door Windows

REG-67FL	1967 Standard LH	69.95 ea.
REG-67FR	1967 Standard RH	69.95 ea.
REG-67FK	1967 Standard LH/RH	118.92 kit
REG-67FXL	1967 Deluxe LH	69.95 ea.
REG-67FXR	1967 Deluxe RH	69.95 ea.
REG-68FL	1968-69 Standard LH	69.95 ea.
REG-68FR	1968-69 Standard RH	69.95 ea.
REG-68FK	1968-69 Standard LH/RH	118.92 kit
REG-68FXL	1968-69 Deluxe LH	69.95 ea.
REG-68FXR	1968-69 Deluxe RH	69.95 ea.
REG-71FL	1970-81 All LH*	69.95 ea.
REG-71FR	1970-81 All RH*	69.95 ea.
REG-71FK	1970-81 All LH/RH*	118.92 kit

Quarter Windows

REG-67FRL	1967-69 All LH	69.95 ea.
REG-67FRR	1967-69 All RH	69.95 ea.

*Will not work on 72-73 Deluxe Interior.



RPP-956

Inner Rear Quarter Patch Panels

Correct repair panel for the lower half of the inner body panel that the rear window regulator mounts to. Easily and professionally repairs the commonly rusted area at the floor and rocker panel.

RPP-957	1967-69 LH	86.99 ea.
RPP-956	1967-69 RH	86.99 ea.



RHS-9

BAV-2622

BAV-2623

Door Hinge Hardware

Correct OEM bolts and heavy spring.

BAV-2622	1967 Phillips	1.99 ea.
BAV-2622K	1967 Phillips 24pc	38.21 kit
BAV-2623	1968-81 Hex	1.99 ea.
BAV-2623K	1968-81 Hex 24pc	38.21 kit
RHS-9	1967-81 Spring	8.99 ea.



RDR-67

RDR-689K

Hinge Detent Rollers

Correct machined detent rollers for lower hinges.

RDR-67	1967 All	16.95 kit
RDR-689K	1968-69 All	21.99 pr.



BPX-1225

Door Hinge Pin Kits

Correct hinge pins and brass bushings for repairing all 4 of your door hinges.

BPX-1225	1967-69 12pc	14.95 ea.
BPX-2225	1970-81 12pc	13.99 ea.

*May require slight drilling to hinges.



RDL-70FL

Door Latch Assemblies

OE style reproduction door latch assemblies.

RDL-67FL	1967 All LH	69.95 ea.
RDL-67FR	1967 All RH	69.95 ea.
RDL-67FK	1967 All LH/RH	111.92 kit
RDL-68FL	1968 All LH	69.95 ea.
RDL-68FR	1968 All RH	69.95 ea.
RDL-68FK	1968 All LH/RH	111.92 kit
RDL-69FL	1969 All LH	69.95 ea.
RDL-69FR	1969 All RH	69.95 ea.
RDL-69FK	1969 All LH/RH	111.92 kit
RDL-70FL	1970-81 All LH	69.95 ea.
RDL-70FR	1970-81 All RH	69.95 ea.
RDL-70FK	1970-81 All LH/RH	111.92 pr.
RDL-SCREW	1967-81 All (Set of 3)*	6.95 set
RDL-828L	1982-87 LH	79.99 ea.
RDL-828R	1982-87 RH	79.99 ea.

*Note: Does one door.

RDH-529U RDH-346LL

1967 Door Hinges
OE style reproduction replacement door hinges.

RDH-529U	1967 Upper LH & RH	49.95 ea.
RDH-346LL	1967 Lower LH	49.95 ea.
RDH-346LR	1967 Lower RH	49.95 ea.

RDH-406UL RDH-211LL

1969 Door Hinges
OE style reproduction replacement door hinges.

RDH-406UL	1969 Upper LH	45.95 ea.
RDH-406UR	1969 Upper RH	45.95 ea.
RDH-211LL	1969 Lower LH	49.95 ea.
RDH-211LR	1969 Lower RH	49.95 ea.
RDH-69FX-K	1969 4pc	172.62 kit

RDH-120UL RDH-248LL

1968 Door Hinges
OE style reproduction replacement door hinges.

RDH-120UL	1968 Upper LH	39.95 ea.
RDH-120UR	1968 Upper RH	39.95 ea.
RDH-248LL	1968 Lower LH	49.95 ea.
RDH-248LR	1968 Lower RH	49.95 ea.

RDH-371UL RDH-926L

1970-81 Door Hinges
OE style reproduction replacement door hinges.

RDH-371UL	1970-81 Upper LH	59.95 ea.
RDH-371UR	1970-81 Upper RH	59.95 ea.
RDH-926L	1970-81 Lower All	42.95 ea.

Quarter Panels

If your original quarter panels are dented or rotted right through to the ground, these exact reproduction quarter panels are the perfect replacement! There is no need to spend a fortune on an NOS quarter because this reproduction features a complete door jamb area, complete trunk jamb area and full roof sail panel. These are extremely high quality pieces, so you can be sure to get the best fit possible.

No Volume Discount. All quarter panels ship Truck Freight to a commercial address.



RFQ-67FL

RFQ-67FL	1967 Coupe LH	349.95 ea.
RFQ-67FR	1967 Coupe RH	349.95 ea.
RFQ-67VL	1967 Convertible LH	339.95 ea.
RFQ-67VR	1967 Convertible RH	339.95 ea.
RFQ-68FL	1968 Coupe LH	349.95 ea.
RFQ-68FR	1968 Coupe RH	349.95 ea.
RFQ-68VL	1968 Convertible LH	339.95 ea.
RFQ-68VR	1968 Convertible RH	339.95 ea.



RFQ-69FL

RFQ-69FL	1969 Coupe LH	349.95 ea.
RFQ-69FR	1969 Coupe RH	349.95 ea.
RFQ-69VL	1969 Convertible LH	339.95 ea.
RFQ-69VR	1969 Convertible RH	339.95 ea.



RFQ-70FL

RFQ-70FL	1970-73 All LH	349.95 ea.
RFQ-70FR	1970-73 All RH	349.95 ea.
RFQ-74FL	1974 All LH	319.95 ea.
RFQ-74FR	1974 All RH	319.95 ea.



RFQ-75FL

RFQ-75FL	1975-81 All LH	319.95 ea.
RFQ-75FR	1975-81 All RH	319.95 ea.



RQS-1067A

Quarter Panel Skins

These quarter panel repair skins offer a quick and inexpensive way to repair your original factory quarter panels without fully cutting them out. They extend from the upper belt line down. Fits all coupes and convertibles.

RQS-1067A	1967-68 All LH	89.95 ea.
RQS-1067B	1967-68 All RH	89.95 ea.
RQS-1067C	1969 All LH	89.95 ea.
RQS-1067D	1969 All RH	89.95 ea.
RQS-F70L	1970-73 LH	109.95 ea.
RQS-F70R	1970-73 RH	109.95 ea.
RQS-F74L	1974-81 LH	109.95 ea.
RQS-F74R	1974-81 RH	109.95 ea.

Side marker holes will have to be cut out for 1968 models. Ships Truck Freight to a commercial address.



4020-603-68L

80% Quarter Panels

These 80% quarter panels are very similar to our full quarter panels but lack the full door jamb section and roof sail panel area. These panels feature turn downs for rear window felts and extend into the trunk weatherstrip area. The rear curves back inward for easy installation of tail pan.

4020-603-67L	1967 All LH	119.95 ea.
4020-603-67R	1967 All RH	119.95 ea.
4020-603-68L	1968 All LH	119.95 ea.
4020-603-68R	1968 All RH	119.95 ea.
4020-603-69L	1969 All LH	119.95 ea.
4020-603-69R	1969 All RH	119.95 ea.

Ships Truck Freight to a commercial address.



RSP-976L RSP-976R

Quarter Trunk Opening Corner Stiffener Plate

This stiffener is welded to the quarter panel on the underside of the trunk lid opening and is commonly missing from previous repairs.

RSP-975L	1967-68 LH	20.99 ea.
RSP-975R	1967-68 RH	20.99 ea.
RSP-976L	1969 LH	20.99 ea.
RSP-976R	1969 RH	20.99 ea.



RBB-67B

Rear Bumper Bolt Reinforcement

This piece welds to the inside of the quarter panel and provides support for mounting the rear bumper bolt.

RBB-67B	1967-68 LH/RH	2.95 ea.
RBB-69B	1969 LH/RH	2.95 ea.

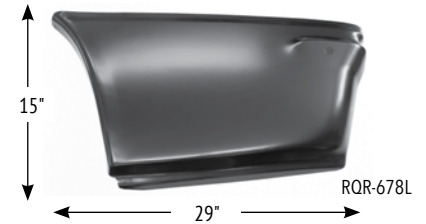

RQR-678L

Quarter Panel Patches

Stamped steel quarter panel patches for repairing the commonly rusted out area behind the wheel opening.

RQR-678L	1967-68 LH 15H x 29L	39.95 ea.
RQR-678R	1967-68 RH 15H x 29L	39.95 ea.
RQR-69L	1969 LH 12H x 25L	39.95 ea.
RQR-69R	1969 RH 12H x 25L	39.95 ea.
RQR-703L	1970-73 LH 15H x 31L	39.95 ea.
RQR-703R	1970-73 RH 15H x 31L	39.95 ea.
RQR-741L	1974-81 LH 17H x 21L	39.95 ea.
RQR-741R	1974-81 RH 17H x 21L	39.95 ea.



RFP-654L

Quarter Window Rear Corner Filler

Supports the edge of the quarter panel where the window felt attaches. Often missing from previous quarter repair, this piece is essential to prevent stress cracks near the end of the drip rail.

RFP-654L	1967-69 LH	14.99 ea.
RFP-654R	1967-69 RH	14.99 ea.



RQD-1022

Quarter Panel & Door Frame Assembly

The massive piece of sheet metal includes the entire inner quarter panel and door structure as well as the windshield pillars, rocker panels and wheelhouses just as pictured. This saves you from the headache of fabricating your own pieces of metal.

RQD-1021B	1967 All LH	999.95 ea.
RQD-1021A	1967 All RH	999.95 ea.
RQD-1023	1968 All LH	999.95 ea.
RQD-1022	1968 All RH	999.95 ea.
RQD-1023B	1969 All LH	999.95 ea.
RQD-1023A	1969 All RH	999.95 ea.

Ships Truck Freight to a commercial address. No Volume Discount.



RWH-671L

Inner Wheelhouses

New inner rear section of wheelhouse which installs between the trunk area and seams to the outer wheelhouse. It is always a good idea to replace your wheelhouses when you replace your quarter panels!

RWH-671L	1967 LH	59.95 ea.
RWH-671R	1967-69 RH	59.95 ea.
RWH-681L	1968-69 LH	62.95 ea.
RWH-681K	1968-69 LH/RH	110.61 kit
RWH-701L	1970-81 LH	99.95 ea.
RWH-701R	1970-81 RH	99.95 ea.

Ships Oversize. No Volume Discount.



RWH-670TL

Outer Wheelhouses

Correct steel wheelhouses which attach to the inside of the quarter panel. It is always a good idea to replace your wheelhouses when you replace your quarter panels!

RWH-670TL	1967-68 LH	49.95 ea.
RWH-670TR	1967-68 RH	49.95 ea.
RWH-670K	1967-68 LH/RH	89.91 kit
RWH-690TL	1969 LH	39.99 ea.
RWH-690TR	1969 RH	39.99 ea.
RWH-690K	1969 LH/RH	67.98 kit
RWH-F700TL	1970-81 LH	64.95 ea.
RWH-F700TR	1970-81 RH	64.95 ea.
RWH-F700K	1970-81 LH/RH	103.92 kit

Ships Oversize. No Volume Discount.



DSE040401

DSE Deep Tubs

Detroit Speed & Engineering deep tubs are inner wheel housings designed to accommodate wider wheel and tire packages. They are engineered for a perfect fit, retain a stock appearance and are stamped from 18 gauge steel. They allow for 335mm tires and 13" wide tires. Made in USA.

DSE040401	1967-69 All	394.99 pr.
DSE040403	1970-81 All	484.99 pr.

Ships Oversize 2. No Volume Discount.

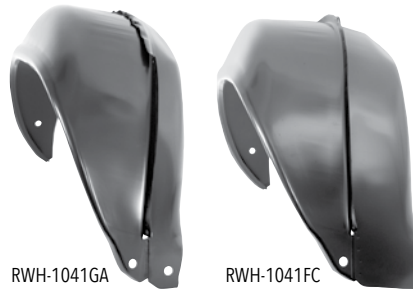

RWH-1041GA

RWH-1041FC

1969 Complete Wheelhouses

Complete wheelhouse assemblies which include the inners and outers already seamed together making installation much easier. Choose from 12.5" stock width or go for 15.25" width to fit larger wheels and tires.

RWH-1041GB	1969 LH 12.50"	129.95 ea.
RWH-1041GA	1969 RH 12.50"	129.95 ea.
RWH-1041GC*	1969 LH 15.25"	144.95 ea.
RWH-1041FC*	1969 RH 15.25"	144.95 ea.

Note: 12.50" standard size has 3-3/4" inner wheelhouse size. 15.25" wider size has 6" inner wheelhouse width.

**To be used in conjunction with RFP-1046AXWT or RFP-1046AGWT, RFR-1068SXWT and RFR-1068RXT.*

Ships Oversize 2. No Volume Discount.



RPB-69L

1967-69 Convertible Quarter Braces

High quality reproduction convertible quarter panel braces.

RPB-678L	1967-68 LH	169.95 ea.
RPB-678R	1967-68 RH	169.95 ea.
RPB-69L	1969 LH	169.95 ea.
RPB-69R	1969 RH	169.95 ea.



RWQ-1041HA

1970-81 Wheelhouse/Quarter Assembly

Full inner quarter panel structure with attached complete wheelhouse.

RWQ-1041JA	1970-81 LH	799.95 ea.
RWQ-1041HA	1970-81 RH	799.95 ea.
RWQ-1041JB	1970-81 LH w/o Outer Wheelhouse	109.95 ea.
RWQ-1041HB	1970-81 RH w/o Outer Wheelhouse	109.95 ea.

Ships Truck Freight to a commercial address. No Volume Discount.



RFB-1046E

Convertible Floor Pan Brace

This one piece brace installs horizontally under the floor for added strength for convertibles.

RFB-1046E	1967-69 Convertible	79.95 ea.
-----------	---------------------	-----------

Ships Oversize



RPP-959



KPS-682L

1967-69 Door Jamb Area Patches

OE style replacement for this often rotted out area in the front of the rocker.

RPP-959	1967-69 LH Outer	79.99 ea.
RPP-958	1967-69 RH Outer	79.99 ea.
KPS-682L	1967-69 LH Inner	49.95 ea.
KPS-682R	1967-69 RH Inner	49.95 ea.

RIP-5970

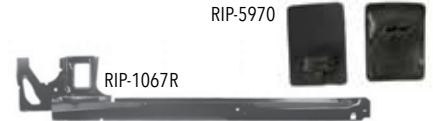

RIP-1067R

Inner Rocker Panels Coupe

OE style reproduction die stamped inner rocker panels for an OE style replacement.

RIP-1067S	1967-69 Coupe LH	84.95 ea.
RIP-1067R	1967-69 Coupe RH	84.95 ea.
RIP-70L	1970-81 LH	89.99 ea.
RIP-70R	1970-81 RH	89.99 ea.
RIP-5970	1967-81 Drain Plugs	6.95 ea.

Ships Oversize



RRP-600L

Outer Rocker Panels Coupe

Correct gauge stamped steel full outer rocker panels with original mounting points.

RRP-600L	1967-69 Coupe LH	65.95 ea.
RRP-600R	1967-69 Coupe RH	65.95 ea.
RRP-700L	1970-81 All LH	82.95 ea.
RRP-700R	1970-81 All RH	82.95 ea.

Ships Oversize



RRP-9VL

Assembled Convertible Rocker Panels

Completely assembled rocker panel correctly stamped for an OE style replacement.

RRP-9VL	1967-69 Convertible LH	299.95 ea.
RRP-9VR	1967-69 Convertible RH	299.95 ea.

Ships Truck Freight to a Commercial Address. No Volume Discount.

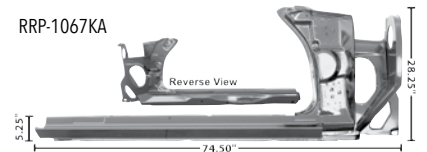

RRP-1067KA

1970-73 Complete Rocker Panels

These complete rocker panel assemblies include both inner rockers and outer rockers making installation much easier than welding together individual pieces.

RRP-1067KB	1970-73 LH	349.95 ea.
RRP-1067KA	1970-73 RH	349.95 ea.

Ships Truck Freight to a Commercial Address. No Volume Discount.

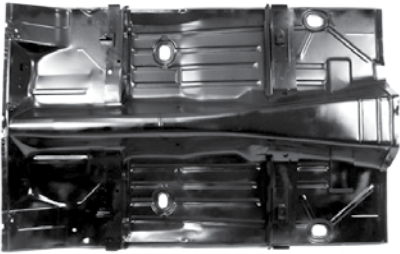

RFP-1046A

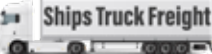

1967-69 Full Floor Pan

This full floor pan is the ultimate solution for your rotted out original floor! This piece features all correct subframe/seat mounting brackets with caged nuts and rear seat mounting brackets. This is the same floor pan we have used on all of our own Camaro projects!

- RFP-1046A 1967-69 All299.95 ea.
 - RFP-1046AX 1967-69 w/ 6 Inch Cutouts*404.95 ea.
- *To be used in conjunction with RFR-1068SXWT, RFR-1068RXT, RWH-1041GC and RWH-1041FC.*

No Volume Discount. Ships Truck Freight to a commercial address.

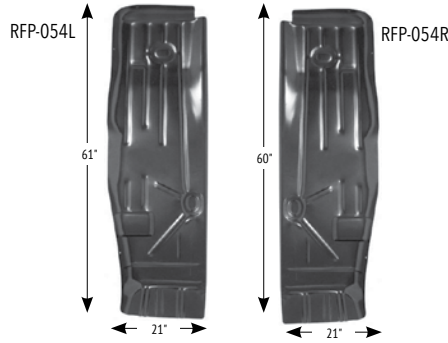

Half Side Floor Pans

Full half side floor panels which seam in the middle. Complete with partial toe board (Exc. 70-81)

- RFP-054L 1967-69 LH, 61" X 21"49.95 ea.
 - RFP-054R 1967-69 RH, 60" X 20"49.95 ea.
 - RFP-089L 1970-81 LH, 57" X 22"*79.95 ea.
 - RFP-089R 1970-81 RH, 57" X 22"*79.95 ea.
- Ships Oversize 2. * 1975-81 may require modification to fit.*



RFP-054L-TNL

RFP-054R-TNL

1967-81 Half Side Floor Pan

Full half side floor pans complete with partial transmission tunnel. 1970-81 come with partial toe board.

- RFP-054L-TNL 1967-69 25" X 62" LH 1/285.95 ea.
 - RFP-054R-TNL 1967-69 25" X 62" RH 1/285.95 ea.
 - RFP-089L-TNL 1970-74 27" X 62" LH 1/2109.95 ea.
 - RFP-089R-TNL 1970-74 27" X 62" RH 1/2109.95 ea.
 - RFP-75L-TNL 1975-81 27" X 61" LH 1/2139.95 ea.
 - RFP-75R-TNL 1975-81 27" X 61" RH 1/2139.95 ea.
- The 1/2 Sections Ship Truck freight.*

Floor Pan Patches

These patches are perfect when only small portions of your floor pan have rusted out.

Front

- RFP-67FL 1967-69 21" x 40" LH49.95 ea.
- RFP-67FR 1967-69 20" x 39" RH49.95 ea.
- RFP-70FL 1970-81 37" x 22" LH*89.95 ea.
- RFP-70FR 1970-81 36" x 22" RH*89.95 ea.

Rear

- RFP-67RL 1967-69 21" x 20" LH45.95 ea.
- RFP-67RR 1967-69 21" x 20" RH45.95 ea.
- RFP-70RL 1970-81 21" x 22" LH*69.95 ea.
- RFP-70RR 1970-81 21" x 22" RH*69.95 ea.

Ships Oversize 1975-81 may require modification to fit.*

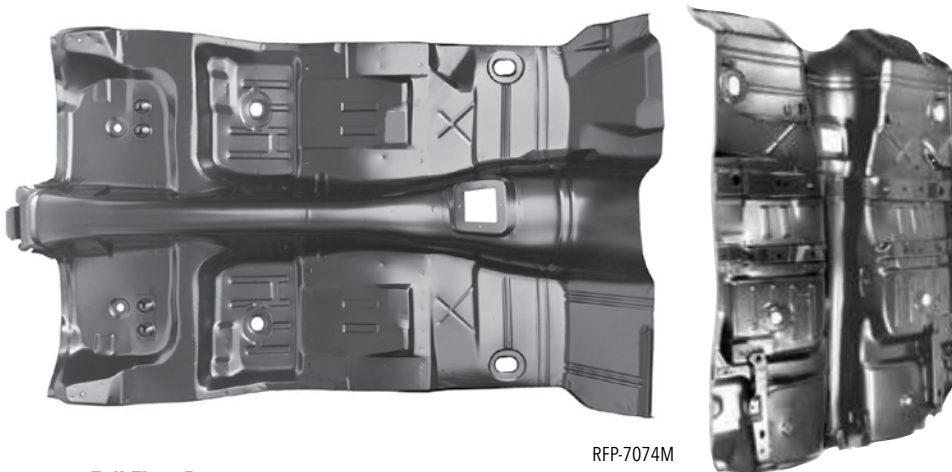
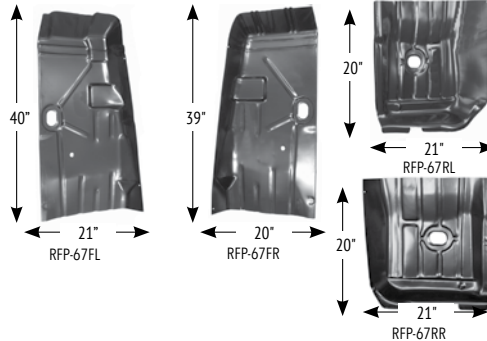

RFP-7074M

1970-81 Full Floor Pan

This full floor pan is available either with or without the braces already installed. Using this new complete floor pan to replace your rotted out floor will save you hours of time and money.

- RFP-1046 Camaro/Firebird 70-73 Full Floor Pan Assy. (All w/o Cutout) w/o Braces, w/o Parking Brake Cable Cover. (Please Note: This Does Not Come with The Torque Box Braces.)319.95 ea.
- RFP-1045Z Camaro/Firebird 70-74 Manual Trans Floor Assy OE Type (w/ Floor Braces, Torque Boxes & Transmission Hump) AMD619.95 ea.
- RFP-7074A Camaro/Firebird Floor Pan Full OE 70-74 Full Floor Panel, Auto Trans, (w/ Center Braces & Rear Torque Box Braces, Also Includes Toe Board Area), 70-74 Cam/FB569.95 ea.
- RFP-7074M Camaro/Firebird Floor Pan Full OE 70-74 w/ Manual Trans Full Floor Panel, Manual Trans, (w/ Center Braces & Rear Torque Box Braces, Also Includes Toe Board Area), 70-74 Cam/FB599.95 ea.
- RFP-7581A Camaro/Firebird 75-81 Auto Trans Floor Assy -OE Type (w/ Floor Braces & Torque Boxes)569.95 ea.
- RFP-7581M Camaro/Firebird 75-81 Manual Trans Floor Assy -OE Type (w/ Floor Braces, Torque Boxes & Transmission Hump)569.95 ea.

No Volume Discount. Ships Truck Freight to a commercial address.

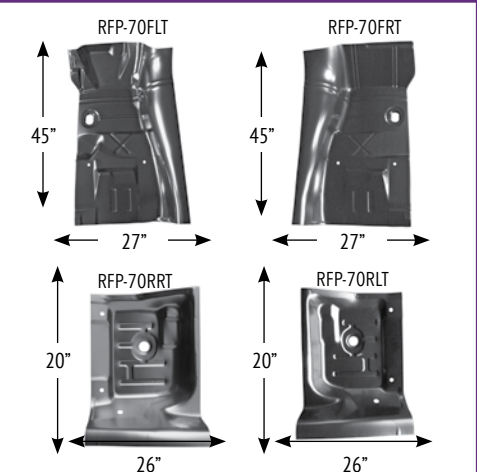

1970-81 Quarter Floor Pans

Quarter floor pans complete with toe board and partial transmission tunnel.

- RFP-70FLT 1970-74 27" X 45" LH Front 1/4 ...79.95 ea.
- RFP-70FRT 1970-74 27" X 45" RH Front 1/4 ...79.95 ea.
- RFP-70RLT 1970-74 26" X 20" LH Rear 1/449.95 ea.
- RFP-70RRT 1970-74 26" X 20" RH Rear 1/449.95 ea.
- RFP-75FLT 1975-81 27" X 44" LH Front 1/4 ...99.95 ea.
- RFP-75FRT 1975-81 27" X 44" RH Front 1/4 ...99.95 ea.
- RFP-75RLT 1975-81 26" X 20" LH Rear 1/449.95 ea.
- RFP-75RRT 1975-81 26" X 20" RH Rear 1/449.95 ea.

Ships Oversize 2.



RTB-126OEL

Toe Boards

These complete factory style extensions connect the front floor pan to the firewall.

RTB-126OEL	1967-69 LH.....	49.95 ea.
RTB-126OER	1967-69 RH.....	49.95 ea.
RTB-F70	1970-81 Complete*.....	199.95 ea.
RTB-70FL	1970-81 LH.....	89.95 ea.
RTB-70FR	1970-81 RH.....	89.95 ea.

*Ships Oversize 2.



MCB-60

Convertible Floor Pan Cross Brace

OE style reproduction stamped steel transmission tunnel brace for under floor pan.

MCB-60	1967-69.....	89.95 ea.
MCB-BOLT	Bolt Kit 6pc.....	5.95 kit



RFB-1046K



RFB-1046J

Front Floor Pan Braces

Stamped steel braces for the front section of the floor pan.

RFB-1046J	1967-69 Convertible RH.....	49.95 ea.
RFB-1046K	1967-69 Convertible LH.....	49.95 ea.



RFB-1075H

1970-81 Floor Pan Braces

OE style reproduction braces for under the floor pan. Complete 3 piece kit.

RFB-1075H	1970-74 All.....	169.95 ea.
RFB-75K	1975-81 All.....	169.95 kit

Ships Oversize



IBX-679F

Rear Seat Floor Hook

Correct hook for rear seat which mounts to the floor pan. Two required per car.

IBX-679F	Most GM Cars.....	7.95 ea.
----------	-------------------	----------



Seat Frame Supports

Correct seat frame supports which attach to the front seat floor brackets.

RSB-1051	1967-69 Coupe LH.....	54.95 ea.
RSB-1050	1967-69 Coupe RH.....	54.95 ea.
RSB-1050K	Coupe LH/RH.....	98.91 kit
RSB-1052B	1967-69 Convertible LH.....	59.95 ea.
RSB-1052A	1967-69 Convertible RH.....	59.95 ea.
RSB-1050VK	Convertible LH/RH.....	107.91 kit



Front Seat Brackets

Correct front seat mounting brackets which spot weld to the floor and also support the rear of the subframe.

RSB-1052L	1967-69 LH.....	39.95 ea.
RSB-1052R	1967-69 RH.....	39.95 ea.



Rear Seat Brackets

Correct rear seat mounting brackets which spot weld to the floor to support the bottom of the rear seat.

RSB-1053L	1967-69 LH.....	36.95 ea.
RSB-1053R	1967-69 RH.....	36.95 ea.



RMP-1001



RMP-1001A

Rear Seat Divider Panel

This is the horizontal divider panel that installs between the rear seat and trunk area and retains the rear seat.

RMP-1001	1967-69 Convertible.....	224.95 ea.
RMP-1001A	1970-73 All.....	224.95 ea.

Ships Oversize

RSB-70FRL



Under Rear Seat Brace (Torque Box)

Welds onto the floor under the rear seat and provides the mounting point for the leaf spring perch bolt.

RSB-67FRL	1967-69 LH.....	49.95 ea.
RSB-67FRR	1967-69 RH.....	49.95 ea.
RSB-70FRL	1970-81 LH.....	79.96 ea.
RSB-70FRR	1970-81 RH.....	79.95 ea.

No Volume Discount



RSB-70L

1967-81 Rear Seat Floor Pan

Correct rear under seat floor pans.

RSP-679	1967-69 Complete All LH & RH 1pc*.....	69.95 ea.
RSP-679L	1967-69 LH All.....	34.95 ea.
RSP-679R	1967-69 RH All.....	34.95 ea.
RSP-70L	1970-81 LH.....	79.95 ea.
RSP-70R	1970-81 RH.....	79.95 ea.

*Ships Oversize 2.



RFR-7L

Full Frame Rails

OE style reproduction full frame rail to replace your rotted original.

RFR-7L	1967 LH.....	169.99 ea.
RFR-7R	1967 RH.....	169.99 ea.
RFR-11L	1968-69 LH.....	134.95 ea.
RFR-11R	1968-69 RH.....	134.95 ea.
RFR-1068SXWT	1968-69 6" Wider LH*.....	219.95 ea.
RFR-1068RXWT	1968-69 6" Wider RH*.....	219.95 ea.
RFR-22L	1970-73 LH.....	219.99 ea.
RFR-22R	1970-73 RH.....	219.99 ea.

*To be used in conjunction with RFP-1046AXWT or RFP-1046AGWT, RWH-1041GC and RWH-1041FC.

Ships Oversize 2



RFR-43L

Rear Frame Rail Repair

These are replacement partial frame rails which are perfect for replacing the rear section. This section measures 45" from the rear shackle forward and includes stamped holes to mount the shackle.

RFR-47L	1967 LH.....	158.95 ea.
RFR-47R	1967 RH.....	158.95 ea.
RFR-48L	1968-69 LH.....	149.95 ea.
RFR-48R	1968-69 RH.....	149.95 ea.
RFR-43L	1970-73 LH.....	189.95 ea.
RFR-43R	1970-73 RH.....	189.95 ea.
RFR-81L	1974-81 LH.....	194.95 ea.
RFR-81R	1974-81 RH.....	194.95 ea.

Ships Oversize 2



Installed

Wiring Harness Shield Kit

Correct galvanized steel shields which attach to the rocker panels in order to protect the wiring harness.

RWS-1008	1967-69 All 4pc.....	109.95 set
----------	----------------------	------------



RSF-69F

RSF-69F Detail

1967-69 OEM Style Sub Frame

OEM style subframe which is an OE style replacement for your rusty, dented or bent original. There is no longer any need to waste money trying to repair your damaged original subframe. This subframe features factory style welds for an OEM appearance, extra bracing in the lower crossmember to add strength while jacking the car (but completely invisible on the outside) and holes and brackets as original. This subframe is very hard to tell from OEM due to all of these correct details.

RSF-67F	19671139.99 ea.
RSF-68F	19681139.99 ea.
RSF-69F	19691139.99 ea.

No Volume Discount. Ships Truck Freight to a commercial address.



RST-67F

Shifter Tunnel Repair Plate

This piece allows you to repair the often hacked up shifter tunnel area without having to replace the whole floor.

RST-67F	1967-69 All69.99 ea.
RST-703	1970-81 All39.95 ea.

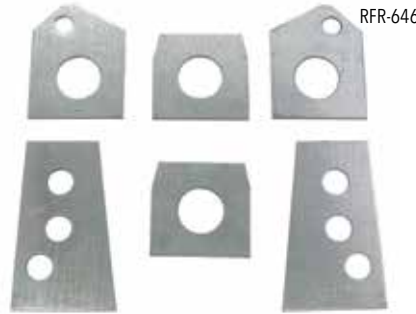

RFR-646

RQE-618L

Sub Frame Repair Plates

Stamped steel plates for repairing your rusted or damaged sub frame mounting points. Complete set of (6) includes radiator support.

RFR-646	1967-81*56.99 kit
---------	----------	----------------

*Modifications will be required to fit 70-81 applications.

Trunk Drop Offs

These die stamped drop offs connect the inside lower rear of the quarter panel to the outside of the trunk.

RQE-618L	1967-68 LH29.95 ea.
RQE-618R	1967-68 RH29.95 ea.
RQE-619L	1969 LH29.95 ea.
RQE-619R	1969 RH29.95 ea.
RQE-703L	1970-73 LH49.95 ea.
RQE-703R	1970-73 RH49.95 ea.
RQE-74L	1974-81 LH49.95 ea.
RQE-74R	1974-81 RH49.95 ea.



RST-679R

Rear Shock Tower Patch

New shock tower repair sections.

RST-679R	1967-69 RH32.99 ea.
RST-67L	1967 LH32.99 ea.
RST-679L	1968-69 LH32.99 ea.



RDP-100

RDP-7488

Trunk/Floor Pan Drain Plug

Correct die stamped floor drain plug.

RDP-100	1967-73 All3.95 ea.
RDP-7488	1974-88 All13.99 ea.



RTF-1046B



Full One Piece Trunk Floor Pans

Like our full floor pans, these trunk floors will save you hours of labor costs and ease to the installation because they include side extensions, trunk to rear body panel braces, fuel tank braces and bumper mounting brackets. These floors truly are complete!

RTF-1046B	1967 w/o Staggered Shocks310.95 ea.
RTF-1046D	1968 w/ Staggered Shocks310.95 ea.
RTF-1046C	1969 All310.95 ea.
RTF-1046CX	1969 w/ Mini Tubes399.95 ea.
RTF-1048Z	1970-73 All299.95 ea.
RTF-7481F	1974-81 All359.95 ea.

No Volume Discount. Ships Truck Freight to a commercial address.



RTF-6782

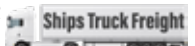

Center Trunk Floor Pans

Correct die stamped center trunk floor pans are perfect when only the center is rusted out.

RTF-6782	1967-68 45W x 38L79.95 ea.
RTF-692	1969 47W x 38L79.95 ea.
RTF-703	1970-73 42W x 37L119.95 ea.
RTF-7481	1974-81 42W x 69L169.95 ea.

Ships Truck Freight to a commercial address.



RTF-69C

Center Trunk Floor Patch

Slightly smaller than the center pans above, these patches can be shipped via ground and do not have to ship truck freight.

RTF-678C	1967-68 44W x 35L75.95 ea.
RTF-69C	1969 44W x 35L69.95 ea.

Ships UPS Oversize 2



RTF-7481F

1974-1981 Camaro Full One Piece Trunk Floor w/ Brackets, Braces

Like our full floor pan, this Camaro full trunk floor pan is a one piece unit that will save you hours of labor costs and installation difficulty over piecing together individual components. This trunk pan features side extensions, trunk to rear body panel braces, fuel tank braces, and bumper mounting brackets.

RTF-7481F 1974-81* 359.95 ea.

*Does Not Come with Frame Rails.

No Volume Discount. Ships Truck Freight to a commercial address.



RTE-678L

RTE-69R

Trunk Floor Extensions

Die stamped panels which extend from the trunk floor to the quarter panel drop offs.

RTE-678L	1967-68 LH.....	55.99 ea.
RTE-678R	1967-68 RH.....	55.99 ea.
RTE-69L	1969 LH.....	55.99 ea.
RTE-69R	1969 RH.....	55.99 ea.



RTF-74



RTF-679

RTF-1058

Trunk Floor/Fuel Tank Braces

Correct braces which attach to the trunk floor and support the fuel tank straps.

RTF-679	1967-68 LH & RH.....	39.95 ea.
RTB-69L	1969 LH.....	39.95 ea.
RTB-69R	1969 RH.....	39.95 ea.
RTF-1058	1970-73 4pc.....	119.95 ea.
RTF-74	1974-81 4pc.....	119.95 set



RDP-67

Package Shelf Repair Panel

This is the piece of metal which is located underneath the rear deck package shelf (speaker panel) and under the rear window to trunk panel. This piece will prevent the hassle of hand fabricating a repair panel for this common rust area.

RDP-67	1967 All.....	125.95 ea.
RDP-689	1968-69 All.....	169.95 ea.
RDP-703	1970-73.....	195.95 ea.

Ships Oversize 2. No Volume Discount.



RSE-679

RSE-703L

RSE-703R

Package Shelf Extensions

OE style reproduction package shelf extension pieces. A great fix for these commonly rotted out areas!

RSE-679	1967-69.....	49.95 pr.
RSE-703L	1970-73 LH.....	39.95 ea.
RSE-703R	1970-73 RH.....	39.95 ea.



RSB-1001D

Rear Seat Back Braces

OE style reproduction die stamped braces to support your rear seat.

RSB-1001D	1967-69.....	64.95 pr.
-----------	--------------	-----------



RCR-70F

RCR-70FL

Rear Cross Rail & Extensions

Correct rear cross rail which is located behind the rear tail light panel. Constructed out of heavy gauge steel as original and EDP coated for rust prevention.

RCR-70F	1970-73 Rear Cross Rail.....	79.95 ea.
RRE-70FL	1970-73 Rear Cross Rail Ext LH.....	23.95 ea.
RRE-70FR	1970-73 Rear Cross Rail Ext RH.....	23.95 ea.
RFR-74F	1974-81 Rear Cross Rail.....	84.95 ea.

Ships Oversize.



RTL-679

Trunk Lids

OE style reproduction of the often rotted or damaged trunk lid.

RTL-679	1967-69 All w/o Spoiler Holes.....	109.95 ea.
RTL-679SP	1967-69 All w/ Pre-Drilled Holes.....	124.95 ea.
RTL-701	1970-81 All w/o Spoiler Holes.....	119.95 ea.
RTL-70SP	1970-81 All w/ Pre-Drilled Holes.....	134.95 ea.

No Volume Discount. Ships Oversize 2.



RWP-1075

OE Style Rear Window to Trunk Panel

This is a correct OE style rear window to trunk panel featuring the inner lip area located inside the rear window above the rear seat.

RWP-1075	1967-69 Coupe.....	72.95 ea.
----------	--------------------	-----------

Ships Oversize.



RWP-679



RWP-70L

Rear Window to Trunk Panel

Reproduction stamped steel panel which fits between the rear window and the trunk lid.

RWP-679	1967-69 Coupe.....	44.95 ea.
RWP-679C	1967-69 Convertible.....	69.95 ea.
RWP-701	1970-73 Outer.....	39.95 ea.
RWP-70L	1970-81 Inner.....	74.95 ea.

Ships Oversize.



RTG-67F

Weatherstrip Gutter

New three piece trunk weatherstrip gutter which is required when replacing your quarters.

RTG-67F	1967-69 3pc.....	49.95 set
RTG-70F	1970-81 2pc.....	66.99 pr.



RTL-1019



RTL-7081

Trunk Lid Latch

OE style reproduction of the often damaged or missing trunk latching device.

RTL-1019	1967-69	29.95 ea.
RTL-7081	1970-81	29.95 ea.



RTC-1067ZA

Trunk Lid Catch

OE style replacement. Originally painted body color.

RTC-1067ZA	1967-69 ALL	18.95 ea.
TLB-716	1967-81 5pc Bolts	8.95 set

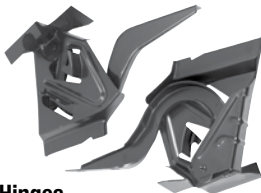

RTH-1049LA

Trunk Hinges

OE style reproduction trunk hinges to replace your damaged originals.

RTH-1049LA	1967-69 All	145.95 pr.
RTH-7081L	1970-81 LH	85.99 ea.
RTH-7081R	1970-81 RH	85.99 ea.



P-2000

Spare Tire Anchor Plates

Correct spare tire hold down and jack floor brackets.

P-2000	1967-69 Anchor Plate	9.95 ea.
--------	----------------------------	----------



RLS-693

Trunk Lid Spring with Sleeve

Correct right side torsion rod and heavy spring used on all models with rear spoiler. Includes heavy molded rubber sleeve. Can also be used on models without rear deck lid spoiler.

RLS-693	1967-69	29.99 ea.
---------	---------------	-----------



RLS-539

1970-81 Trunk Hinge Torque Rod

Reproduction trunk hinge torque rod manufactured as original from precision bent steel. Designed to hold the trunk lid up when open.

RLS-539	1970-81 LH	24.99 ea.
RLS-538	1970-81 RH w/o Spoiler	24.99 ea.
RLS-540	1970-81 RH w/ Spoiler	24.99 ea.



RTB-1067X

Trunk Torsion Bracket

Correct trunk lid support bracket which the trunk lid bolts to. This piece welds to the body of the car. Complete with tension spring bars.

RTB-1067X	1967-69 Convertible	239.95 ea.
-----------	---------------------------	------------

Ships Oversize



MS149-05M

Eddie Motorsports Billet Trunk Hinges

M = Machined, P = Polished, CA = Clear Anodized, B = Blue, PR = Purple, R = Red, BKA = Gloss Black, MBA = Matte Black
 WILL NOT WORK ON CONVERTIBLES

	<u>M</u>	<u>P</u>	<u>All Others</u>
MS149-05_	1967-69	315.99 pr. ..	340.99 pr.
MS149-06_	1970-81	219.99 pr. ..	240.99 pr.



R-1067W

R-1067Z

RTB-1067V

Rear Inner Panel Braces

Correct center of inner panel braces which attach to the inner tail light panel for the trunk latch.

R-1067Z	1967-68 All	39.95 ea.
R-1067W	1969 All	39.95 ea.
RTB-1067V	1970-73 All	54.95 ea.



RTB-4

RTB-3

RTB-1

Trunk Floor Tail Panel Braces

These OE style reproduction braces extend from the rear trunk pan to the tail panel for rear bumper mounting.

RTB-3	1967-68 Large Inner	22.99 ea.
RTB-4	1969 Large Inner	39.99 pr.
RTB-1	1969 Small Corner	24.99 pr.

REP-678



REP-69



REP-703



Rear End Tail Panels

Complete rear panels which extend above and below the rear bumper and from right to left quarter panels.

REP-678	1967-68 Standard	99.95 ea.
REP-678RS	1967-68 RS w/ Pre-Cut Holes	95.95 ea.
REP-69	1969 All	109.95 ea.
REP-69-RS	1969 RS w/ Pre-Cut Holes	119.95 ea.
REP-703	1970-73 All	99.95 ea.

Ships Oversize 2.



RIP-678



RIP-678RS



RIR-1067



RIP-74



RIP-781

Rear Inner Panels

Stamped rear inner panel. 1967-69 installs behind the rear end tail panel and 1974-81 installs behind the urethane bumper cover.

RIP-678	1967-68 Standard.....	69.95 ea.
RIP-678RS	1967-68 RS w/ Pre-cut Holes	99.95 ea.
RIR-1067	1969 All	75.95 ea.
RIP-74	1974-77 All	74.95 ea.
RIP-781	1978-81 All	74.95 ea.

Ships Oversize 2.



RTP-703



RTP-741

Lower Tail Panel Patch

Die stamped steel lower tail panel patches which are perfect when only the lower section of your tail panel is rotted.

RTP-703	1970-73 Approx 9" Tall	49.95 ea.
RTP-741	1974-81 Approx 5" Tall	49.95 ea.

Ships Oversize.



CT-727 Detail

RS Reverse Lens Mounting Template

Correct template which shows the tail panel hole locations for the RS backup lamp housings.

CT-724	1967-68 RS	34.99 ea.
CT-727	1969 RS	34.99 ea.



Roof Panel

Excellent reproduction roof panel skin which will replace your rotted out original exactly. 1970-73 comes with or without A-pillars installed.

RA00003	1967-69 All	259.95 ea.
RA7074	1970-74 All	339.95 ea.
RP-7073F	1970-73 w/ A-Pillars.....	749.95 ea.
RP-1004K	1975-81	349.95 ea.

Ships Truck Freight to a commercial address.



RBK-1A



RBK-1B

Roof Panel Braces

Complete set of roof panel reinforcement braces. A must when replacing your roof panel!

RBK-1A	1967-68 7pc	199.95 ea.
RBK-1B	1969 14pc.....	199.95 ea.

Ships Oversize 2



KPR-106A

Drip Rail Support

Correct metal support that runs along the edge of the roof and retains the drip rail. This support is painted body color.

KPR-107A	1967-69 LH.....	89.95 ea.
KPR-106A	1967-69 RH	89.95 ea.

Ships Oversize 2



KPR-106

Pillar Drip Rail Support

Correct metal support that runs along the edge of the A-pillar and retains the drip rail. This support is painted body color.

KPR-107	1967-69 LH.....	49.95 ea.
KPR-106	1967-69 RH	49.95 ea.
KRP-756	1970-81 Rear of Door	49.99 pr.



MCT-1000



RPS-1000A

Convertible Top Frame

This high quality reproduction steel convertible top frame is complete with fully reinforced hinge mechanisms along with everything you need to complete this rusted out frame. Designed for power top models.

MCT-1000	1967-69 Convertible Frame.....	999.95 ea.
RPS-1000A	1967-69 B-Pillar Supports	89.95 pr.

Ships Truck Freight to a commercial address. No Volume Discount.



RRC-69

Roof Weatherstrip Channel

High luster stainless steel like original. Bolts onto the roof channel to retain the roof rail weatherstrip.

RRC-67F	1967 Coupe 6pc	199.95 kit
RRC-69	1968-69 Coupe 6pc	199.95 kit

This item ships Oversize. No volume discount.